

CATALOGO / CATALOGUE 2026/27.

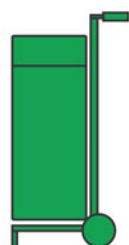

METALCARRELLI[®]
WWW.METALCARRELLI.COM

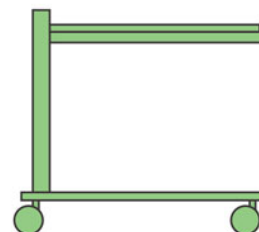

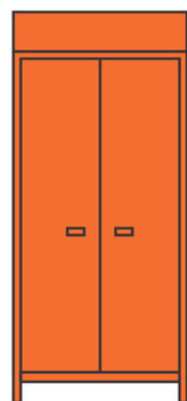
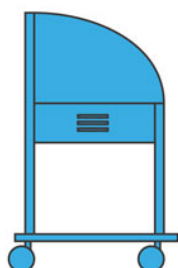
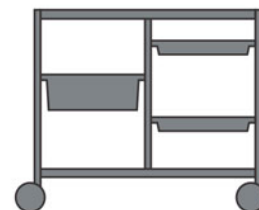
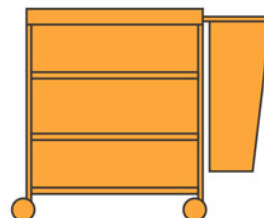
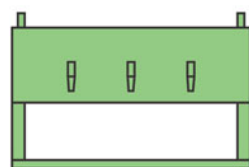
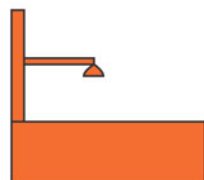
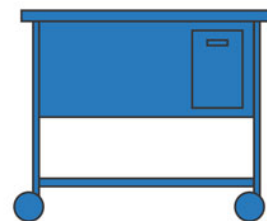
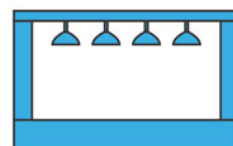
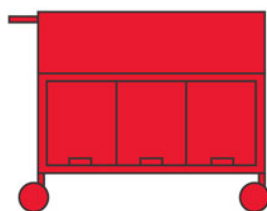
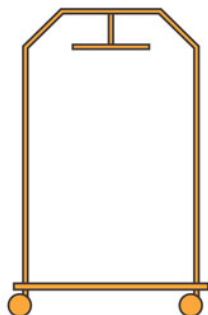
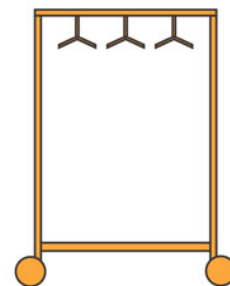
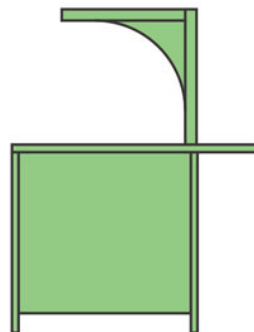
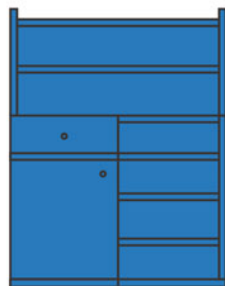
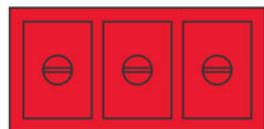
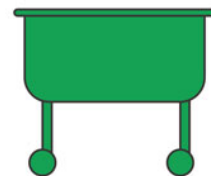
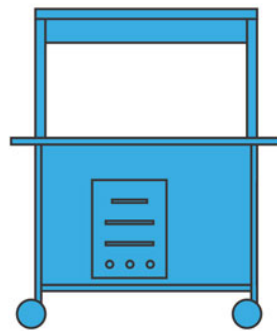
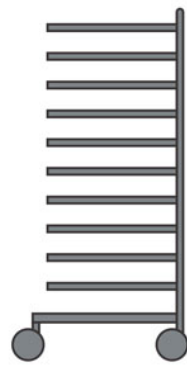
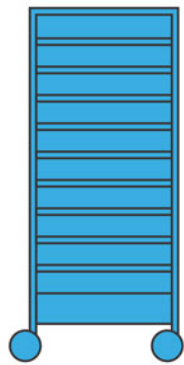
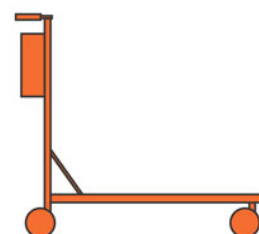

METALCARRELLI®
1964 - 2024 ANNIVERSARY



HOTEL

AFFIDABILE

oltre 60 anni di esperienza
nel settore HO.RE.CA.

RELIABLE

*more than 50 years of experience
in the HO.RE.CA. sector*



RESTAURANT

GARANTITO

qualità Made in Italy:
produciamo in casa con i migliori materiali

GUARANTEED

*Made in Italy quality: we manufacture
our products with the best materials*



CATERING

GLOBALE

a 360° è il servizio che ti offriamo
dal pre al post-vendita

COMPLETE

*we grant you a comprehensive service
both before and after sales*



HOSPITAL

PUNTUALE

consegna veloce e puntuale
per le tue esigenze

TIMELY

*our products are delivered quickly
and timely to meet all your needs*



CHI SIAMO

Metalcarrelli progetta, sviluppa e costruisce carrelli ed attrezzature per utilizzo professionale in hotel, ristoranti, ospedali, comunità, mense, catering, ecc.

Nata in un'officina artigianale nel 1964, l'azienda ha sviluppato un importante e proprio know-how ed investito per ottimizzare la propria produzione, divenendo industria leader sul mercato e partner di riferimento per la nostra vasta clientela nazionale ed estera.

Offriamo al mercato un catalogo molto ampio, composto da oltre 1000 articoli caratterizzati da un'eccellente qualità e da un servizio sempre a supporto dei nostri clienti.

LA NOSTRA STORIA

La storia di Metalcarrelli ha inizio presso l'hotel "Pensione Petrucci" negli anni '60, quando, durante la bassa stagione, il sig. Petrucci comincia a produrre artigianalmente alcune attrezzature per hotel di cui ha bisogno e fonda nel 1964 la propria azienda. Nel 1970 il sig. Picchi entra a far parte dell'organizzazione dell'azienda ed inizia lo sviluppo di nuove aree di business.

A partire dall'anno 2000 vengono introdotte, con investimenti mirati, nuove tecnologie e si promuovono la ricerca e lo sviluppo al fine di produrre carrelli sempre più affidabili e con tecnologia sempre più avanzata.

Nel 2018 Metalcarrelli sviluppa la progettazione di una nuova gamma prodotti: i "nastri di confezionamento" ed altre linee prodotto complementari che andranno ad integrare la gamma destinata ai centri di distribuzione alimentare.

Nel corso dell'anno 2022 G.L.G. Holding rileva l'azienda, attuando un nuovo piano di crescita e sviluppo.

POLITICA E VALORI

Siamo vicini ai nostri clienti e forniamo loro tutti gli strumenti per incrementare e migliorare il loro business.

Il nostro obiettivo è quello di stabilire e sviluppare rapporti di collaborazione di lunga durata, grazie ad un team di persone altamente qualificato, ad un'organizzazione strutturata ed alla realizzazione di prodotti di prima qualità.

OUR HISTORY

Metalcarrelli was founded in 1964 as a craft workshop and has developed an important know-how in manufacturing hi-tech professional equipment for the Ho.re.co. and meal distribution industry over time.

By constantly investing in optimizing the production processes and focusing on research and development, Metalcarrelli has soon become a leading company on the market and a trusted partner for a very large number of domestic and foreign customers.

We strongly believe in the importance of "Made in Italy" and we manufacture our trolleys with the best materials, to provide our customers with excellent quality products as well as with reliable and efficient solutions at competitive prices.

WHO WE ARE

Nowadays, Metalcarrelli offers a very wide product range, including trolleys and complementary elements for hotels, restaurants and laundries (stainless steel and wooden service trolleys, buffets, housekeeping trolleys and room service tables with food warmers, roll containers), hospitals and retirement homes (conveyor belts, bain-marie trolleys on cupboard), schools and canteens (bain-marie trolleys and tray trolleys) and catering (heated, refrigerated and neutral tray/container cupboard trolleys and platform trucks).

VISITA IL NOSTRO SITO

VISIT OUR WEBSITE

www.metalcarrelli.com

YOUR
INTERNATIONAL
PARTNER



VENDITE
SALES

vendite@metalcarrelli.com

**GESTIONE
ORDINI**
**ORDER
MANAGEMENT**

info@metalcarrelli.com

MARKETING
MARKETING

marketing@metalcarrelli.com

EXPORT
EXPORT

sales@metalcarrelli.com

1) OPERATIVITÀ DELLE CONDIZIONI DI VENDITA: le condizioni generali di vendita si intendono accettate sin dall'invio dell'ordine e perfezionate con l'accettazione dell'ordine stesso da parte della Metalcarrelli s.r.l.

2) DEROGHE / MODIFICHE: L'ordine implica l'integrale accettazione delle presenti nostre condizioni di vendita, alle quali NON è ammessa deroga o modificazione alcuna, se non espressamente convenuta per iscritto;

3) ORDINI INDIRETTI: Le ordinazioni ricevute da Metalcarrelli s.r.l. attraverso intermediari e/o agenti di vendita, si intendono sottoposte alla condizione "salvo approvazione della società venditrice" che, quindi, resta libera di non accettare l'ordine a proprio insindacabile giudizio;

4) PREZZI: I prezzi del listino in vigore al momento dell'ordine sono da intendersi franco fabbrica e al netto di I.V.A. La Metalcarrelli s.r.l. si riserva il diritto di modificare i prezzi senza preavviso, qualora intervengano significative variazioni dei costi delle materie prime, della mano d'opera o di altri oneri, (ad esempio fiscali), di qualsiasi natura. Il prezzo finale applicato al cliente sarà comunque quello indicato sulla conferma d'ordine;

5) IMBALLAGGIO: in caso di spedizione alla destinazione indicata dal cliente, il materiale viene imballato in cartone, o cartone pallettizzato, idoneo al tipo di prodotto. Eventuali imballaggi extra saranno addebitati al cliente. Il prezzo extra sarà indicato nella conferma d'ordine o per scritto prima della spedizione;

6) TRASPORTO: La merce viaggia a rischio del committente anche se venduta in porto franco. Spettano pertanto al destinatario la responsabilità di verificare lo stato dei materiali al momento della consegna;

7) RECLAMI: in caso di avaria e/o danneggiamenti il cliente è tenuto, inderogabilmente, ad inoltrare eventuali reclami alla Metalcarrelli s.r.l. entro le 24 ore successive al ritiro, per scritto, a mezzo raccomandata ar da anticipare a mezzo fax o PEC. La garanzia opera soltanto se il danno viene comunicato nei termini e nelle modalità sopra descritte, nonché attraverso la procedura che segue: il cliente/ destinatario dovrà apporre sul DDT o sulla fattura accompagnatoria e/o sul bollettino di trasporto la seguente dicitura "collo non integro, si accetta la merce con riserva di controllo", indicando una breve descrizione del danno. La merce danneggiata deve restare, con l'imballaggio originale, nella disponibilità della Metalcarrelli s.r.l. per le opportune verifiche.

Nel caso di mancato rispetto delle modalità sopra descritte la Metalcarrelli s.r.l. non assume responsabilità di alcun genere;

8) TERMINI DI CONSEGNA: I termini di consegna indicati nella conferma d'ordine sono puramente indicativi. Eventuali ritardi non costituiscono motivo di rinuncia all'acquisto, di modificazione degli accordi specificati sulla commissione e, in nessun caso, possono costituire motivo di rivalsa e/o richiesta di risarcimento danni nei confronti della Metalcarrelli s.r.l.;

9) GARANZIA: Il produttore garantisce le merci per la durata di 12 mesi dalla data di acquisto. La garanzia opera per i vizi dovuti ai materiali o alle lavorazioni e sono escluse le parti elettriche (resistenze, termostati, compressori, lampade, interruttori, etc.) nonché tutti i materiali soggetti ad usura (ruote, spazzole, etc.);

9a) Procedura per l'attivazione della garanzia: I prodotti ritenuti difettosi devono essere accuratamente imballati nel loro imballo originale e spediti alla Metalcarrelli s.r.l. in porto franco. Ogni eventuale intervento in garanzia è effettuato esclusivamente presso la nostra sede di Bellaria I.M. (RN) - Italy ed il materiale riparato o sostituito, viene nuovamente spedito al cliente senza applicazione di ulteriori spese. Reclami e/o contestazioni devono essere comunicati entro e non oltre 8 (otto) giorni dalla data della manifestazione del vizio e/o del difetto e, comunque, entro i 12 mesi dalla consegna;

10) CERTIFICAZIONE: la Metalcarrelli s.r.l. dichiara che i prodotti illustrati nel catalogo rispondono alle normative Europee vigenti al momento dell'ordine;

11) RESI: la Metalcarrelli s.r.l. non accetta resi totali o parziali della merce inviata al cliente, se non preventivamente concordati per scritto tra le parti. l'accettazione del reso è ad insindacabile giudizio della Metalcarrelli s.r.l. In caso di reso accettato, la merce dovrà essere restituita integra e non utilizzata a spese, cura e responsabilità del cliente nel suo imballo originale. In nessun caso saranno accettati resi di articoli in acciaio inox ai quali è stata tolta la protezione o di articoli speciali eseguiti su misura;

12) PAGAMENTI: Nessun pagamento sarà valido se non effettuato direttamente al domicilio della Metalcarrelli s.r.l., a mezzo bonifico o assegno. Nel caso di pagamento ad un incaricato della Metalcarrelli s.r.l. lo stesso sarà ritenuto liberatorio soltanto se la quietanza è accompagnata dalla copia di regolare autorizzazione scritta della società al proprio incaricato. Il ritardo nei pagamenti, come qualsiasi altra inadempienza contrattuale, comporta la sospensione di ogni ulteriore fornitura;

12a) INTERESSI DI MORA: è facoltà del produttore applicare l'interesse commerciale di mora. In caso di controversia, l'acquirente non ha alcun diritto di ritardare o rifiutare il pagamento delle forniture;

13) RISERVATO DOMINIO: Le vendite con pagamento differito si intendono eseguite con riserva di proprietà – RISERVATO DOMINIO – in favore del produttore fino all'avvenuto saldo. In tal caso il cliente non potrà alienare i beni sino al saldo ed anche il mancato pagamento di una sola scadenza comporterà l'immediata restituzione dei beni, se richiesti dalla Metalcarrelli s.r.l.;

14) FORO COMPETENTE: In caso di controversia sulla esecuzione e/o interpretazione dell'ordine, dell'accettazione d'ordine e/o delle presenti clausole, le parti stabiliscono, come unico Foro competente, quello di Rimini;

15) INDICAZIONI RIPORTATE NEL CATALOGO: Il produttore si riserva il diritto di modificare, in qualsiasi momento e senza alcun avviso, le dimensioni e l'esecuzione dei prodotti elencati nel presente catalogo. Le illustrazioni, le fotografie, le descrizioni inserite nel catalogo in essere al momento dell'accettazione dell'ordine, si intendono come indicazioni generali e non costituiscono vincolo e possono non corrispondere alla effettiva conformazione dei prodotti;

16) DISEGNI ED ILLUSTRAZIONI: I disegni, le illustrazioni di vario genere indicati dal produttore unitamente ad una proposta di fornitura, ad un contratto così come nel catalogo sono riservati alla Metalcarrelli s.r.l. e si intendono di proprietà esclusiva della stessa;

17) MARCHI E BREVETTI: è fatto espresso divieto di utilizzare i marchi e/o i brevetti registrati dalla Metalcarrelli s.r.l.

Il presente catalogo annulla e sostituisce tutti i precedenti. Le immagini e le caratteristiche dei prodotti in esso contenute sono coperte da copyright. L'utilizzo o la riproduzione delle medesime sono soggetti ad autorizzazione da parte della Metalcarrelli S.r.l. proprietaria del marchio e detentrica dei diritti di proprietà materiale ed intellettuale. I prezzi potranno subire variazioni nel caso di errori tipografici.

1) EFFECTIVENESS OF THE GENERAL SALES TERMS AND CONDITIONS: the general sales terms and conditions are deemed accepted on sending the order and finalised on acceptance of the order by Metalcarrelli s.r.l.

2) EXCEPTIONS/MODIFICATIONS: the order implies full acceptance of our current sales terms and conditions to which NO exception or modification whatsoever is permitted, unless expressly agreed in writing.

3) INDIRECT ORDERS: orders received by Metalcarrelli s.r.l. through intermediaries and/or sales agents are subordinate to the clause "subject to approval by the selling company" and the latter is therefore, free to refuse the order at its own uncontested discretion.

4) PRICES: the listed prices applicable at the time the order is placed are ex-works and net of VAT. Metalcarrelli s.r.l. reserves the right to change prices without notification should there be significant changes in the cost of raw materials, labour or any other costs whatsoever (for example, fiscal costs). However, the final price applied to the customer will be the one indicated on the order confirmation.

5) PACKAGING: in the event of shipping to the destination indicated by the customer, the material will be packed in boxes or pallets suited to the type of product. Any additional packaging will be charged to the customer and the additional price indicated on the order confirmation or in writing prior to shipment.

6) TRANSPORT: goods travel at the sole risk of the customer, even if sold free port. Therefore, it is the recipient's responsibility to check the state of the material at the time of delivery.

7) COMPLAINTS: in the event of any loss and/or damage to shipments the customer must send any complaints to Metalcarrelli s.r.l. within 24 hours of delivery in writing by registered letter with return receipt, to be forwarded in advance by fax or certified email.

The guarantee is only valid if any damage is communicated within the timescale and using the methods described above, as well as following the below procedure: the customer/recipient should indicate the words "box not intact, goods accepted unchecked" on the transport document, accompanying invoice and/or delivery note, giving a brief description of the damage. Damaged goods should be kept in their original packaging and made available to Metalcarrelli s.r.l. for the appropriate checks. Metalcarrelli s.r.l. will not accept any responsibility whatsoever in the event of failure to comply with the above procedure.

8) DELIVERY TERMS: the delivery terms indicated on the order confirmation are merely indicative. Any delays do not constitute a reason for waiving the purchase or modifying the agreements specified on the order and in no case whatsoever do they constitute a reason for compensation and/or claim for damages against Metalcarrelli s.r.l.

9) GUARANTEE: the producer guarantees the goods for 12 months from the date of purchase. The guarantee is valid for faults due to the materials or processing, whilst electrical parts (resistors, thermostats, compressors, lamps, switches, etc.) and all materials subject to wear and tear (wheels, brushes, etc.) are excluded.

9a) Procedure for activating the guarantee: any products considered faulty must be carefully packed in their original packaging and returned to Metalcarrelli s.r.l. free port. Any intervention under guarantee will be carried out exclusively at our offices in Bellaria I.M. (RN), Italy and repaired or replaced material will be returned to the customer at no further cost. Any complaints and/or objections must be communicated no more than 8 (eight) days of the fault and/or defect being detected and in any case, within 12 months of delivery.

10) CERTIFICATION: Metalcarrelli s.r.l. declares that the products illustrated in the catalogue comply with all European legislation applicable at the time of the order.

11) RETURNS: Metalcarrelli s.r.l. will not accept either total or partial returns of goods sent to the customer, unless this is agreed in advance in writing by the parties. Acceptance of returns is at the uncontested discretion of Metalcarrelli s.r.l. In the event of a return being accepted, goods should be returned intact and unused, in their original packaging, at the sole expense and responsibility of the customer. In no case whatsoever will stainless steel items be accepted for returns if the protection has been removed. Likewise, special made-to-measure items cannot be returned.

12) PAYMENTS: payments will not be valid unless made directly to Metalcarrelli s.r.l., either by bank transfer or cheque. In the event of payment being made to a person appointed by Metalcarrelli s.r.l., the said payment will only be deemed paid in full if the receipt is accompanied by a copy of the standard written authorisation by the company to its appointee. Any delays in payments as well as any other contractual breaches will lead to suspension of future supplies.

12a) interest on arrears: it is the faculty of the producer to apply commercial interest on arrears. In the event of any controversy, the purchaser does not have the right to delay or refuse to pay for supplies.

13) TITLE RETENTION: sales with deferred payment are considered fulfilled with retention of title – TITLE RETENTION – in favour of the producer until the full balance has been paid. In the event, the customer cannot transfer goods until the balance payment has been made and failure to meet even a single deadline will imply the immediate return of goods if requested by Metalcarrelli s.r.l.

14) COMPETENT COURT: in the event of any controversy regarding the fulfilment and/or interpretation of the order, acceptance of the same and/or the present clauses the parties agree that the only competent court will be the Court of Rimini.













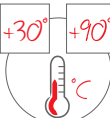
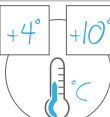
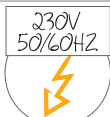

15) INDICATIONS GIVEN IN THE CATALOGUE: the producer reserves the right to modify, at any time and without notification, the dimensions and execution of the products listed in the present catalogue. The illustrations, photographs and descriptions in the catalogue applicable at the time of acceptance of the order should be considered general indications, however they do not constitute a restriction and may not correspond to the effective shape and structure of the products.

16) DRAWINGS AND ILLUSTRATIONS: the various drawings and illustrations indicated by the producer along with the supply offer or contract, as well as those in the catalogue, are reserved for Metalcarrelli s.r.l. and are the sole property of the same.





17) BRANDS AND PATENTS: it is expressly forbidden to use brands and/or patents registered by Metalcarrelli s.r.l.

The present catalogue cancels and replaces all previous ones. The images and product specifications contained herein are covered by copyright. Any use or reproduction of the same are subject to authorisation by Metalcarrelli S.r.l., which owns the brand and holds material and intellectual property rights. Prices may be subject to change in the event of printing errors.

SIMBOLOGIA SYMBOLS

	Riscaldato: indica la presenza di vasche o vani riscaldati	<i>Heated wells or compartments</i>
	Refrigerato: indica la presenza di vasche o vani refrigerati	<i>Refrigerated wells or compartments</i>
	Misto: indica la compresenza di vasche o vani refrigerati e riscaldati	<i>Refrigerated and heated wells or compartments</i>
	Neutro: indica la presenza di vasche o vani neutri	<i>Neutral wells or compartments</i>
	Temperatura caldo: indica l'intervallo di temperatura di esercizio	<i>Heating temperature: operating temperature range</i>
	Temperatura freddo: indica l'intervallo di temperatura di esercizio	<i>Refrigeration temperature: operating temperature range</i>
	Alimentato elettricamente: indica la presenza di alimentazione elettrica	<i>Electrically powered</i>
	Portata: indica la portata massima di un carrello in kg	<i>Loading capacity: max loading capacity (total kg)</i>
	Capacità: indica la capacità della bacinella	<i>Suitable for Gastronorms</i>
	Capacità: indica la capacità della teglia	<i>Suitable for trays</i>
	Requisito igienico H1	<i>H1 Hygiene system</i>
	Diametro bicchieri: indica il diametro minimo/massimo dei bicchieri	<i>Min/Max glass diameter</i>
	Diametro piatti: indica il diametro minimo/massimo dei piatti	<i>Min/Max plate diameter</i>
	Alimentato a gas: indica la presenza di alimentazione a gas	<i>Gas powered</i>
	Ventilato: indica la presenza di un sistema di ventilazione per gli elementi riscaldati e refrigerati	<i>Ventilation system for heated and refrigerated elements</i>
	Robusto: indica alta resistenza agli sforzi	<i>Sturdy: highly resistant to stress</i>

DIDASCALIE KEY

	Finitura/Colore: indica la finitura o i colori disponibili	<i>Finish/Colour: finishes or colours available</i>
	Ruote elastiche adatte a pavimenti sconnessi	<i>Resilient castors/wheels for uneven floors and outdoor use</i>
	Foto o disegno numerato	<i>Numbered photo or drawing</i>
OPTIONAL	Da richiedere esclusivamente al momento dell'ordine	<i>To be selected exclusively when placing the order</i>
ACCESSORIO ACCESSORY	Acquistabile anche a posteriori	<i>Can be purchased later as well</i>
	Canale Youtube Metalcarrelli dove trovare video inerenti ai nostri prodotti	<i>Product shown on Metalcarrelli Youtube channel</i>
	Neutro	<i>Neutral</i>
	Caldo	<i>Hot</i>
	Freddo	<i>Cold</i>
	Guida a "C" per bacinelle GN	<i>"C" shaped runners for GN bacs</i>
	Guida a "L" per vassoi	<i>"L" shaped runners for trays</i>
	Guida stampata	<i>Pressed runners</i>

1

PAG. 11

Carrelli di servizio in acciaio
 Carrelli trasporto piatti e sbarazzo
 Pensili e carrelli scolapiatti, bicchieri e vassoi
 Carrelli portacestelli

Metal service trolleys
Tableware handling trolleys
Dispensers for plates, glasses and trays
Rack stacking trolleys

2

PAG. 29

Carrelli portateglie
 Carrelli portavassoi

Tray trolleys
Pan trolleys

3

PAG. 51

Carrelli termici a giorno
 Carrelli termici armadiati
 Bacinelle e coperchi GN

Bain-marie trolleys
Cupboard trolleys
GN containers and lids

4

PAG. 81

Armadi portateglie e portavassoi neutri,
 riscaldati e refrigerati

*Mobile tray/pan cupboards - neutral,
 heated and refrigerated*

5

PAG. 103

Carrelli Colazione
 Elementi per la distribuzione pasti
 Nastri trasportatori
 Sollevatori vassoi, piatti e cesti
 Carrelli inox refrigerati

Breakfast trolleys
Meal distribution units
Conveyor belts
Trays, plates and racks dispensers
Refrigerated trolleys

6

PAG. 127

Piani caldi
Lampade riscaldanti
Tavole calde da banco
Sterilizza coltelli
Tramogge e vasche carrellate
Mobiletti scaldapiatti
Colonne portapiatti
Vetrine riscaldate e refrigerate

Countertop hotplates
Infrared lamps
Countertop bain-marie units
Knife sterilizers
Wells and waster collectors
Plate warmer cabinets
Plate stackers
Heated and refrigerated display cases

7

PAG. 143

Carrelli di servizio in legno e portaliquori
Carrelli di servizio in legno "modern style"
Carrelli flambé
Mobili di servizio in legno
Carrelli di servizio in legno e acciaio

Wooden service trolleys
"Modern Style" wooden service trolleys
Flambé
Wooden waiter's service stations
Stainless steel and wood service trolleys

8

PAG. 157

Carrelli espositivi refrigerati in legno
Buffet riscaldati, refrigerati e misti in legno
Drop-in

Wooden refrigerated trolleys
Wooden refrigerated and mixed buffet trolleys
Drop-in

9

PAG. 181

Cestoni lavanderia
Roll container
Armadi portascopo e spogliatoio
Scaffalature
Pattumiere inox
Lavamani
Portacasse

Linen trucks
Roll containers
Changing room and broom lockers
Storage shelving systems
Stainless steel waste bins
Hand washers
Platform trucks

10

PAG. 203

Stender e carrelli appendiabiti e portabagagli
Reggivaligie
Carrelli per il servizio in camera
Carrelli rifornimento minibar
Carrelli portabiancheria
Pattumiere e portasacco
Svuotavassoio
Pattumiere per raccolta differenziata
Posacenere/gettacarte
Porta ombrelli

Reception trolleys
Luggage trolleys
Room service trolleys
Minibar restocking trolleys
Chambermaid trolleys
Waste bins
Fast-food bins
Recycling bins
Waste/paper bins
Umbrella stands



	CARRELLI DI SERVIZIO A PIANI STAMPATI <i>SERVICE TROLLEYS WITH PRESSED SHELVES</i>	PAG. 12
	CARRELLI DI SERVIZIO TRASPORTO PESANTE <i>HEAVY-DUTY SERVICE TROLLEYS</i>	PAG. 15
	CARRELLI DI SERVIZIO A PIANI ASPORTABILI <i>SERVICE TROLLEYS WITH REMOVABLE SHELVES</i>	PAG. 17
	CARELLI PER SBARAZZO <i>CLEARING TROLLEYS</i>	PAG. 19
	CARRELLI PER TRASPORTO PIATTI, VASSOI E BICCHIERI <i>PLATE/TRAY/GLASS TROLLEYS</i>	PAG. 20
	CARRELLI E PENSILI SCOLAPIATTI, BICCHIERI E VASSOI <i>PLATE/TRAY/GLASS DRAINING TROLLEYS AND HANGING DRAINERS</i>	PAG. 22
	CARRELLI PORTACESTELLI <i>RACK TROLLEYS</i>	PAG. 26

CARRELLI DI SERVIZIO A PIANI STAMPATI / IMBULLONATI AISI 304 STAINLESS STEEL SERVICE TROLLEYS WITH BOLTED PRESSED SHELVES

- Realizzati completamente in acciaio inox AISI 304, finitura spazzolata
- Struttura in tubo tondo ø cm 2.5
- Piani stampati a forma di vassoio con superfici arrotondate,insonorizzati, imbullonati al telaio
- Paracolpi in gomma grigia
- Ruote piroettanti ø cm 12,5

- AISI 304 stainless steel trolleys, brushed finish
- Round tube frame ø 2.5 cm
- Tray shaped stainless steel pressed shelves bolted to the frame, sound-proof and with no sharp edges
- Grey rubber ring buffers
- Swivel castors, ø 12.5 cm



Art. 1400

ARTICOLO / ARTICLE	PREZZO / PRICE	PIANI / SHELVES	DIM. PIANO / SHELF CM	MAX DIM. CM
1400C	€ 331,00	2	80x50	89x59x95 h
1405C	€ 424,00	3		89x59x95 h
1410C	€ 532,00	4		89x59x126 h
1400C5	€ 649,00	5		89x59x160 h
1400	€ 367,00	2	100x50	109x59x95 h
1405	€ 477,00	3		109x59x95 h
1410	€ 601,00	4		109x59x126 h
14005	€ 733,00	5		109x59x160 h
1402	€ 391,00	2	100x60	109x69x95 h
1407	€ 513,00	3		109x69x95 h
1412	€ 646,00	4		109x69x126 h
14025	€ 783,00	5		109x69x160 h
14032	€ 457,00	2	120x60	129x69x95 h
14033	€ 612,00	3		129x69x95 h
14034	€ 779,00	4		129x69x126 h

OPTIONAL	PREZZO / PRICE	IMMAGINE	DESCRIZIONE / DESCRIPTION	PER / FOR
F	€ 28,00	1	Set 2 ruote con freno Set with 2 braked castors	Tutti gli articoli All Articles
E	€ 200,00	2	Set 4 ruote elastiche, di cui 2 con freno Set with 4 resilient castors, 2 with brake	

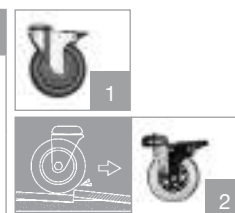

OPTIONAL	PREZZO / PRICE	IMMAGINE	DESCRIZIONE / DESCRIPTION	PER / FOR
AB02	€ 84,00	3	Bacinella portarifiuti in PVC, cm 33x16x51 h PVC waste bin, 33x16x51 h cm	Tutti gli articoli All Articles
AB01	€ 42,00	4	Bacinella portarifiuti in PVC, cm 35x19x18 h PVC waste bin, 35x19x18 h cm	



CARRELLI DI SERVIZIO A PIANI STAMPATI / SALDATI AISI 304 STAINLESS STEEL SERVICE TROLLEYS WITH WELDED PRESSED SHELVES

- Realizzati completamente in acciaio inox AISI 304, finitura spazzolata
- Struttura in tubo tondo ø cm 2.5
- Piani stampati a forma di vassoio con superfici arrotondate, insonorizzati, saldati al telaio
- Paracolpi in gomma grigia
- Ruote piroettanti ø cm 12,5



- *AISI 304 stainless steel trolleys, brushed finish*
- *Round tube frame ø 2.5 cm*
- *Tray shaped stainless steel pressed shelves welded to the frame, sound-proof and with no sharp edges*
- *Grey rubber ring buffers*
- *Swivel castors, ø 12.5 cm*





Particolare piano saldato
Welded shelf detail

Art. 1405S

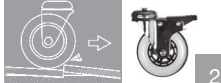
ARTICOLO / ARTICLE	PREZZO / PRICE	PIANI / SHELVES	DIM. PIANO / SHELF CM	MAX DIM. CM
1400CS	€ 372,00	2	80x50	89x59x95 h
1405CS	€ 464,00	3		89x59x126 h
1410CS	€ 647,00	4		89x59x126 h
1400S	€ 407,00	2	100x50	109x59x95 h
1405S	€ 516,00	3		109x59x126 h
1410S	€ 718,00	4		109x59x126 h
1402S	€ 435,00	2	100x60	109x69x95 h
1407S	€ 554,00	3		109x69x126 h
1412S	€ 772,00	4		109x69x126 h
14032S	€ 476,00	2	120x60	129x69x95 h
14033S	€ 620,00	3		129x69x126 h
14034S	€ 791,00	4		129x69x126 h

OPTIONAL	PREZZO / PRICE	IMMAGINE	DESCRIZIONE / DESCRIPTION	PER / FOR	IMMAGINE
F	€ 28,00	1	Set 2 ruote con freno Set with 2 braked castors	Tutti gli articoli All Articles	
E	€ 200,00	2	Set 4 ruote elastiche, di cui 2 con freno Set with 4 resilient castors, 2 with brake		

OPTIONAL	PREZZO / PRICE	IMMAGINE	DESCRIZIONE / DESCRIPTION	PER / FOR	IMMAGINE
AB02	€ 84,00	3	Bacinella portarifiuti in PVC, cm 33x16x51 h PVC waste bin, 33x16x51 h cm	Tutti gli articoli All Articles	
AB01	€ 42,00	4	Bacinella portarifiuti in PVC, cm 35x19x18 h PVC waste bin, 35x19x18 h cm		

CARRELLO INOX MULTIFUNZIONE - TRASPORTO, SBARAZZO, COLAZIONI

MULTIPURPOSE STAINLESS STEEL TROLLEYS - TRANSPORT, CLEARING, BREAKFAST SERVICE

- Carrello di servizio inox AISI 304 a piani stampati saldati, pannellato su tre lati e provvisto di sportelli frontali
- Struttura in tubo tondo di acciaio inox AISI 304 Ø mm 25, finitura spazzolata
- 3 piani stampati cm 100x60, a forma di vassoio con superfici arrotondate, insonorizzati, saldati al telaio
- Sportelli dotati di piega salvamani e bordi arrotondati, apribili fino a 270°, con magneti di bloccaggio a porta aperta e a porta chiusa
- Portata kg 150
- Paracolpi in gomma grigia
- 4 ruote piroettanti Ø mm 125, di cui 2 con freno.
- Dimensioni cm 109x69xh.95

- *AISI 304 stainless steel service trolley with welded pressed shelves, panelled on three sides and equipped with front doors*
- *Structure in AISI 304 stainless steel round tube Ø 2.5 cm, brushed finish*
- *3 pressed shelves 100x60 cm, tray-shaped with rounded surfaces, soundproof, welded to the frame*
- *Doors equipped with hand-safe folds and rounded edges, opening up to 270°, magnetically locked both when doors are closed and opened.*
- *Load capacity 150 kg*
- *Grey rubber bumpers*
- *4 swivel castors Ø 125 mm, 2 with brakes*
- *Dimensions mm 1090x690xh.950*

**NOVITÀ
NEW**



Art. 1402S.PS



ARTICOLO / ARTICLE	PREZZO / PRICE	PIANI / SHELVES	DIM. PIANO / SHELF CM	MAX DIM. CM
1402S.PS	€ 1.130,00	2	100x60	109x69x95 h
1407S.PS	€ 1.250,00	3		

OPTIONAL	PREZZO / PRICE	📷	DESCRIZIONE / DESCRIPTION	PER / FOR
E	€ 200,00	2	Set 4 ruote elastiche, di cui 2 con freno Set with 4 resilient castors, 2 with brake	Tutti gli articoli All Articles

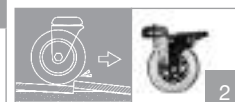

CARRELLI DI SERVIZIO - TRASPORTO PESANTE STAINLESS STEEL HEAVY-DUTY TROLLEYS

- Realizzati completamente in acciaio inox AISI 304, finitura spazzolata
- Struttura portante costituita da telaio chiuso in tubo tondo ø cm 2.5
- Piani stampati a forma di vassoio con superfici arrotondate, insonorizzati, saldati al telaio
- Paracolpi in gomma grigia
- Ruote piroettanti ø cm 12,5 di cui 2 con freno
- Disponibile anche in versione smontata con portata 150kg

- *AISI 304 stainless steel trolleys, brushed finish*
- *Round tube closed frame ø 2.5 cm*
- *Tray shaped stainless steel pressed shelves welded to the frame, sound-proof and with no sharp edges*
- *Grey rubber ring buffers*
- *Swivel castors ø 12.5 cm, 2 with brake*
- *Also available in disassembled version with 150kg capacity*



Art. 1402P

ARTICOLO / ARTICLE SALDATA / WELDED	ARTICOLO / ARTICLE SMONTATA / DISASSEM.	PREZZO / PRICE	PIANI / SHELVES	DIM. PIANO / SHELF CM	MAX DIM. CM
1400CP	1400CPI	€ 486,00	2	80x50	89x59x95 h
1405CP	1405CPI	€ 578,00	3		
1400P	1400PI	€ 525,00	2	100x50	109x59x95 h
1405P	1405PI	€ 641,00	3		
1402P	1402PI	€ 560,00	2	100x60	109x69x95 h
1407P	1407PI	€ 686,00	3		
1403P2	1403P2I	€ 666,00	2	120x60	129x69x95 h
1403P3	1403P3I	€ 838,00	3		

OPTIONAL	PREZZO / PRICE		DESCRIZIONE / DESCRIPTION	PER / FOR	
E	€ 97,00	2	Set 4 ruote elastiche, di cui 2 con freno Set with 4 resilient castors, 2 with brake	Tutti gli articoli All Articles	

OPTIONAL	PREZZO / PRICE		DESCRIZIONE / DESCRIPTION	PER / FOR	
AB02	€ 84,00	3	Bacinella portarifiuti in PVC, cm 33x16x51 h PVC waste bin, 33x16x51 h cm	Tutti gli articoli All Articles	
AB01	€ 42,00	4	Bacinella portarifiuti in PVC, cm 35x19x18 h PVC waste bin, 35x19x18 h cm		

CARRELLI DI SERVIZIO - TRASPORTO PESANTE STAINLESS STEEL HEAVY-DUTY TROLLEYS

SERIE 1560

- Realizzati completamente in acciaio inox AISI 304, finitura spazzolata
- Struttura in tubo quadro cm 2,5x2,5
- Piani in lamiera, lisci (serie PL) o a vasca (serie PV), saldati al telaio
- Paracolpi in gomma grigia
- Ruote piroettanti ø cm 12,5, di cui 2 con freno

1560 SERIES

- AISI 304 stainless steel trolleys, brushed finish
- Stainless steel 2.5x2.5 cm square tube frame
- Steel sheet pressed flat shelves (PL range) or deep tray shelves (PV range), welded to the frame
- Grey rubber ring buffers
- Swivel castors with plate support, ø 12.5 cm, 2 with brake



SERIE 1570

- Realizzati completamente in acciaio inox AISI 304, finitura spazzolata
- Struttura in tubo quadro cm 2,5x2,5
- Piani in lamiera, lisci (serie PL) o a vasca (serie PV) con omega di rinforzo, saldati al telaio
- Paracolpi in gomma angolari
- Ruote piroettanti, supporto a piastra, ø cm 16 su cuscinetti, di cui 2 con freno

1570 SERIES

- AISI 304 stainless steel trolleys, brushed finish
- Stainless steel 2.5x2.5 cm square tube frame
- Steel sheet pressed flat shelves (PL range) or deep tray shelves (PV range) with reinforcing bar, welded to the frame
- Rubber corner bumpers
- Swivel castors with support plate and roller bearings, ø 16 cm, 2 with brake

Art. 1560-2PV



Art. 1570-2PV

1560 SERIE / SERIES

ARTICOLO / ARTICLE	PREZZO / PRICE	PIANI / SHELVES	DIM. PIANO / SHELF CM	MAX DIM. CM
1560-2PL	€ 559,00	2 lisci / 2 flat	100x58	108x61x93 h
1560-3PL	€ 666,00	3 lisci / 3 flat		
1560-2PV	€ 570,00	2 a vasca / 2 deep tray		
1560-3PV	€ 684,00	3 a vasca / 3 deep tray		

1570 SERIE / SERIES

ARTICOLO / ARTICLE	PREZZO / PRICE	PIANI / SHELVES	DIM. PIANO / SHELF CM	MAX DIM. CM
1570-2PL	€ 844,00	2 lisci / 2 flat	100x58	108x61x96 h
1570-3PL	€ 1.012,00	3 lisci / 3 flat		
1570-2PV	€ 855,00	2 a vasca / 2 deep tray		
1570-3PV	€ 1.027,00	3 a vasca / 3 deep tray		

OPTIONAL	PREZZO / PRICE	DESCRIZIONE / DESCRIPTION	PER / FOR
AB02	€ 84,00	3 Bacinella portarifiuti in PVC, cm 33x16x51 h PVC waste bin, 33x16x51 h cm	Tutti gli articoli All Articles
AB01	€ 42,00	4 Bacinella portarifiuti in PVC, cm 35x19x18 h PVC waste bin, 35x19x18 h cm	



CARRELLI DI SERVIZIO - PIANI ASPORTABILI
 STAINLESS STEEL SERVICE TROLLEYS - REMOVABLE SHELVES

- Struttura in tubo quadro di acciaio inox AISI 304 cm 2x2, finitura spazzolata
- Piani asportabili in acciaio inox a forma di vasca, con bordo a 90° antitaglio, profondità cm 1,5 o 6,5 (a seconda del modello)
- Paracolpi in gomma grigia agli angoli
- Ruote piroettanti ø cm 12,5



- AISI 304 stainless steel 2x2 cm square tube frame, brushed finish
- Stainless steel 1.5 or 6.5 cm-deep tray shelves (depending on the model)
- with 90° no-sharp edges
- Grey rubber ring buffers
- Swivel castors, ø 12.5 cm



Art. 1516







Art. 1526



Particolare piano asportabile
 Removable shelf detail

ARTICOLO / ARTICLE	PREZZO / PRICE	PIANI / SHELVES	PROFONDITÀ PIANI CM / DEPTH SHELVES CM	DIM. PIANO / SHELF CM	MAX DIM. CM
1516	€ 297,00	2	1,5	47x44	58x51x91 h
1517	€ 371,00	3			58x51x110 h
1520	€ 332,00	2		75x44	86x51x91 h
1521	€ 423,00	3			86x51x110 h
1522	€ 512,00	4			86x51x126 h
1523	€ 349,00	2		87x44	98x51x91 h
1524	€ 448,00	3			98x51x110 h
1525	€ 544,00	4			98x51x126 h
1526	€ 413,00	2	6,5	87x44	98x51x91 h
1527	€ 544,00	3			98x51x110 h

OPTIONAL	PREZZO / PRICE	IMMAGINE	DESCRIZIONE / DESCRIPTION	PER / FOR	IMMAGINE
F	€ 28,00	1	Set 2 ruote con freno Set with 2 braked castors	Tutti gli articoli All Articles	 1
E	€ 200,00	2	Set 4 ruote elastiche, di cui 2 con freno Set with 4 resilient castors, 2 with brake		 2

OPTIONAL	PREZZO / PRICE	IMMAGINE	DESCRIZIONE / DESCRIPTION	PER / FOR	IMMAGINE
AB02	€ 84,00	3	Bacinella portarifiuti in PVC, cm 33x16x51 h PVC waste bin, 33x16x51 h cm	Tutti gli articoli All Articles	 3
AB01	€ 42,00	4	Bacinella portarifiuti in PVC, cm 35x19x18 h PVC waste bin, 35x19x18 h cm		 4

CARRELLI DI SERVIZIO A PIANI STAMPATI STAINLESS STEEL SERVICE TROLLEYS WITH PRESSED SHELVES

- Realizzati completamente in acciaio inox AISI 201
- Struttura in tubo tondo ø cm 2,5
- Piani stampati satinati a forma di vassoio con bordi arrotondati, insonorizzati ed imbullonati al telaio
- Paracolpi in gomma grigia
- Ruote piroettanti ø cm 10, di cui 2 con freno
- MADE IN PRC

- *AISI 201 stainless steel trolleys*
- *Round tube frame ø 2.5 cm*
- *Tray shaped stainless steel pressed shelves bolted to the frame, sound-proof and with no sharp edges, brushed finish*
- *Grey rubber buffers*
- *Swivel castors ø 10 cm, 2 with brake*
- *MADE IN PRC*



Art. 2P100-50



Art. 3P100-50

ARTICOLO / ARTICLE	PREZZO / PRICE	PIANI / SHELVES	DIM. PIANO / SHELF CM	MAX DIM. CM
2P80-50	€ 270,00	2	80x50	89x59x94 h
3P80-50	€ 348,00	3		
2P100-50	€ 301,00	2	100x50	109x59x94 h
3P100-50	€ 370,00	3		
2P100-60	€ 328,00	2	100x60	109x69x94 h
3P100-60	€ 409,00	3		

OPTIONAL	PREZZO / PRICE		DESCRIZIONE / DESCRIPTION	PER / FOR
AB02	€ 84,00	1	Bacinella portarifiuti in PVC, cm 33x16x51 h PVC waste bin, 33x16x51 h cm	Tutti gli articoli All Articles
AB01	€ 42,00	2	Bacinella portarifiuti in PVC, cm 35x19x18 h PVC waste bin, 35x19x18 h cm	



- Struttura in tubo quadro di acciaio inox AISI 304 cm 2,5x2,5, finitura spazzolata con pannelli laterali in lamiera di acciaio inox completamente saldati
- Piano inferiore in lamiera di acciaio inox, con invaso
- Paracolpi in gomma grigia
- Ruote piroettanti ø cm 12,5



- AISI 304 stainless steel 2.5x2.5 cm square tube frame with stainless steel sheet side panels welded throughout the length, brushed finish
- Stainless steel sheet lower shelf with raised edge
- Grey rubber ring buffers
- Swivel castors, ø 12.5 cm

Optional bacinelle vedi pag. 78-79
Optional Gastronorms: see pp. 78-79



Art. 1515V-F



Particolare vasca stagna (1515V)
Watertight well detail (1515V)



Part. telaio senza fondo (1515S)
Detail for structure without bottom (1515S)



Art. 1515-F

ARTICOLO / ARTICLE	PREZZO / PRICE	LIVELLO SUPERIORE / TOP SURFACE	H MAX CM BACINELLE / PANS	DIM. PIANO / SHELF CM	MAX DIM. CM
1515S	€ 520,00	Telaio senza fondo per bacinelle 3x1/1 GN (escluse) Holding structure without bottom for 3x1/1 GN pans (not included)	20	105x51	117x63x94 h
1515	€ 824,00	Telaio senza fondo + bacinelle 1x2/1 GN + 2x1/2 GN (comprese) Structure without bottom + pans 1x2/1 GN + 2x1/2 GN (included)			
1515V	€ 823,00	Vasca stagna + rubinetto Watertight well + tap			

OPTIONAL	PREZZO / PRICE	DESCRIZIONE / DESCRIPTION	PER / FOR
F	€ 28,00	Set 2 ruote con freno Set with 2 braked castors	Tutti gli articoli All Articles
E	€ 200,00	Set 4 ruote elastiche, di cui 2 con freno Set with 4 resilient castors, 2 with brake	

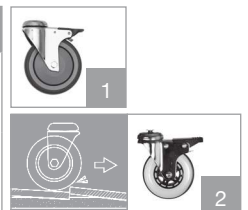

OPTIONAL	PREZZO / PRICE	DESCRIZIONE / DESCRIPTION	PER / FOR
AB02	€ 84,00	Bacinella portarifiuti in PVC, cm 33x16x51 h PVC waste bin, 33x16x51 h cm	Tutti gli articoli All Articles
AB01	€ 42,00	Bacinella portarifiuti in PVC, cm 35x19x18 h PVC waste bin, 35x19x18 h cm	



CARRELLI PER TRASPORTO PIATTI / VASSOI PLATE / TRAY TROLLEYS

- Struttura portante in tubo quadro di acciaio inox AISI 304 cm 2x2
- Pareti in lamiera di acciaio inox AISI 304
- Base appoggio piatti inclinata antiribaltamento
- Ripiano inferiore inox (a seconda del modello)
- Paracolpi in gomma grigia
- Ruote piroettanti ø cm 12,5



- *AISI 304 stainless steel 2x2 cm square tube frame*
- *AISI 304 stainless steel sheet side panels*
- *Inclined base to prevent sliding*
- *Additional lower stainless steel shelf (depending on the model)*
- *Grey rubber ring buffers*
- *Swivel castors, ø 12.5 cm*



Art. 1270-F



Art. 1272-F



Art. 1272-F + A0255

ARTICOLO / ARTICLE	PREZZO / PRICE	PIANI / SHELVES	MAX DIM. CM
1270	€ 506,00	1	84x51x91 h
1272	€ 570,00	2	84x51x116 h

OPTIONAL	PREZZO / PRICE	DESCRIZIONE / DESCRIPTION	PER / FOR
F	€ 28,00	Set 2 ruote con freno Set with 2 braked castors	Tutti gli articoli All Articles
A0254	€ 144,00	Rivestimento in PVC con cerniere PVC cover with zipper	1270
A0255	€ 187,00		1272

CARRELLI PER TRASPORTO PIATTI / VASSOI / BICCHIERI
PLATE / TRAY / GLASS TROLLEYS

- Struttura portante in tubo di acciaio inox quadro AISI 304, cm 2x2
 - Pareti e ripiano in lamiera di acciaio inox AISI 304
 - Base appoggio piatti inclinata antiribaltamento
 - Griglie in filo di acciaio inox AISI 304 (optional)
 - Ruote piroettanti ø cm 12,5 di cui 2 con freno
- *AISI 304 stainless steel 2x2 cm square tube frame*
 - *AISI 304 stainless steel sheet side panels and base*
 - *Inclined base to prevent from sliding*
 - *AISI 304 stainless steel wire dividers (optional)*
 - *Swivel castors, ø 12.5 cm, 2 with brake*

200 kg



Art. 1270PR-E + A0056(x2)



Art. 1270P + A0056(x2)

ARTICOLO / ARTICLE	PREZZO / PRICE	PIANI / SHELVES	MAX DIM. CM
1270P	€ 627,00	1	90x60x91 h
1270PR	€ 755,00	2	90x60x102 h

ACCESSORI / ACCESSORIES	PREZZO / PRICE	DESCRIZIONE / DESCRIPTION	PER / FOR
A0056	€ 67,00	Griglia singola di separazione amovibile in acciaio inox AISI 304 <i>AISI 304 stainless steel single removable wire divider</i>	Tutti gli articoli <i>All Articles</i>
A0260	€ 235,00	Rivestimento in PVC con cerniere <i>PVC cover with zipper</i>	

OPTIONAL	PREZZO / PRICE	DESCRIZIONE / DESCRIPTION	PER / FOR
E	€ 97,00	Set 4 ruote elastiche, di cui 2 con freno, per pavimenti sconnessi o per esterni <i>Set of 4 resilient wheels, 2 with brake for uneven floors / outdoor use</i>	Tutti gli articoli <i>All Articles</i>

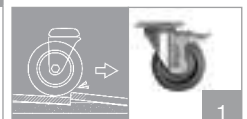

CARRELLI SCOLAPIATTI - BICCHIERI CROCKERY AND GLASSWARE DRAINING TROLLEYS

- Struttura in tubo quadro di acciaio inox AISI 304 cm 2x2 o cm 2,5x2,5 (Art. 5034 - 5036 - 5038)
- Griglie portapiatti in lamiera di acciaio inox con invaso stampato antitaglio
- Vasca scolabicchieri-raccogliogocce in ABS termoformato, estraibile, chiusa con tappo a tenuta
- Ruote piroettanti ø cm 12,5

- AISI 304 tainless steel 2x2 cm square tube frame, or 2.5x2.5 cm square tube frame (Art. 5034 - 5036 - 5038)
- Stainless steel sheet crockery racks with no sharp edges
- Removable thermoformed ABS glass racks with drip tray and watertight plug
- Swivel castors, ø 12.5 cm



Art. 5020-F





Art. 5024-F



Art. 5022-F

ARTICOLO / ARTICLE	PREZZO / PRICE	PORTATA PIATTI / PLATE CAP	Ø CM PIATTI / DISHES	SCOLAPIATTI / CROCKERY RACKS	SCOLABICCHIERI / GLASS RACKS	MAX DIM. CM
5002	€ 833,00	180	16÷26	3	-	87x62x121 h
5004	€ 838,00	120		2	1	
5006	€ 843,00	60		1	2	
5020	€ 903,00	216		3	-	
5022	€ 894,00	144	16÷32	2	1	102x62x121 h
5024	€ 888,00	72		1	2	
5034	€ 947,00	216		3	-	
5036	€ 940,00	144	16÷32	2	1	102x69x134 h
5038	€ 934,00	72		1	2	

OPTIONAL	PREZZO / PRICE	📷	DESCRIZIONE / DESCRIPTION	PER / FOR	
F	€ 28,00	1	Set 2 ruote con freno Set with 2 braked castors	Tutti gli articoli All Articles	 1
A0282	€ 178,00	2	Rivestimento in PVC con cerniere PVC cover with zipper	5002 - 5004 - 5006	 2
A0284	€ 192,00			5020 - 5022 - 5024	
A0289	€ 255,00			5034 - 5036 - 5038	

CARRELLI SCOLAPIATTI - BICCHIERI CROCKERY AND GLASSWARE DRAINING TROLLEYS

- Struttura in tubo quadro di acciaio inox AISI 304 cm 2x2
- Griglie portapiatti in lamiera di acciaio inox con invaso stampato antitaglio
- Vasca scolabicchieri-raccogliogocce in ABS termoformato, estraibile, chiusa con tappo a tenuta
- Ruote piroettanti ø cm 12,5



- AISI 304 stainless steel 2x2 cm square tube frame
- Stainless steel sheet crockery racks with no sharp edges
- Removable thermoformed ABS glass racks with drip tray and watertight plug
- Swivel castors, ø 12.5 cm



Art. 5026-F



Art. 5032-F

ARTICOLO / ARTICLE	PREZZO / PRICE	PORTATA PIATTI / PLATE CAP	Ø CM PIATTI / DISHES	SCOLAPIATTI / CROCKERY RACKS	SCOLABICCHIERI / GLASS RACKS	MAX DIM. CM
5012	€ 1.063,00	240	16÷26	4	-	87x62x159 h
5014	€ 1.063,00	180		3	1	
5016	€ 1.063,00	120		2	2	
5018	€ 1.063,00	60		1	3	
5026	€ 1.144,00	288		4	-	102x62x159 h
5028	€ 1.138,00	216		3	1	
5030	€ 1.130,00	144		2	2	
5032	€ 1.123,00	72		1	3	

OPTIONAL	PREZZO / PRICE	DESCRIZIONE / DESCRIPTION	PER / FOR
F	€ 28,00	Set 2 ruote con freno Set with 2 braked castors	Tutti gli articoli All Articles
A0286	€ 200,00	Rivestimento in PVC con cerniere PVC cover with zipper	5012 - 5014 5016 - 5018
A0288	€ 219,00		5026 - 5028 5030 - 5032



PENSILI SCOLAPIATTI E SCOLABICCHIERI HANGING DRAINERS

- Struttura in tubo quadro di acciaio inox AISI 304 cm 2x2
- Griglie portapiatti in lamiera di acciaio inox con invaso stampato antitaglio
- Cestelli scolabicchieri in lamiera di acciaio inox con fondo forato
- Ferramenta per fissaggio al muro esclusa



- *AISI 304 stainless steel 2x2 cm square tube frame*
- *Stainless steel sheet crockery racks with no sharp edges*
- *Stainless steel sheet glass racks with drip tray*
- *Hardware for wall-mounting not included*



Art. 5062



Art. 5064



Art. 5066

ARTICOLO / ARTICLE	PREZZO / PRICE	PORTATA PIATTI / PLATE CAP	Ø CM PIATTI / DISHES	SCOLAPIATTI / CROCKERY RACKS	SCOLABICCHIERI / GLASS RACKS	MAX DIM. CM
5052	€ 223,00	60	16÷32	2	-	83x42x48 h
5054	€ 232,00	30		1	1	
5056	€ 241,00	-	-	-	2	
5062	€ 241,00	72	16÷32	2	-	98x42x48 h
5064	€ 285,00	36		1	1	
5066	€ 277,00	-		-	-	

- Struttura in tubo quadro di acciaio inox AISI 304 cm 2,5x2,5
- Griglie in filo di acciaio inox
- Vasca raccogli gocce in ABS termoformato, chiusa con tappo a tenuta
- Ruote piroettanti ø cm 12,5

- *AISI 304 stainless steel 2.5x2.5 cm square tube frame*
- *Stainless steel wire dividers*
- *Thermoformed ABS lower drip tray with watertight plug*
- *Swivel castors, ø 12.5 cm*



Art. 2264

ARTICOLO / ARTICLE	PREZZO / PRICE	PORTATA VASSOI-COPERCHI / TRAY/LID CAPACITY	MAX DIM. CM
2264	€ 945,00	60	102x62x143 h

OPTIONAL	PREZZO / PRICE	DESCRIZIONE / DESCRIPTION	PER / FOR
F	€ 28,00	Set 2 ruote con freno Set with 2 braked castors	Tutti gli articoli All Articles
A0270	€ 288,00	Rivestimento in PVC con cerniere PVC cover with zipper	



PORTACESTELLI RACK STACKING TROLLEYS

- Base in polietilene lineare, foro di scarico chiuso con tappo (Art. 2205P - 2206P)
- Base in acciaio inox (Art. 2202P - 2203P - 2207P - 2208P)
- Base in plastica ABS (Art. 1837)
- Manico in acciaio inox (a seconda del modello)
- Ruote piroettanti ø cm 9,5
- Ruote piroettanti ø cm 10 (Art. 1837)

- *Linear polyethylene support with drain hole and plug (Art. 2205P - 2206P)*
- *Stainless steel base (Art. 2202P - 2203P - 2207P - 2208P)*
- *ABS plastic base (Art. 1837)*
- *Stainless steel handle (depending on the model)*
- *Swivel castors ø 9.5 cm*
- *Swivel castors ø 10 cm (Art. 1837)*

Art. 2206P



Art. 2205P



Art. 2207P



Art.1837



Art. 2202P

ARTICOLO / ARTICLE	PREZZO / PRICE	DESCRIZIONE / DESCRIPTION	MATERIALE / MATERIAL	DIM. BASE CM	MAX DIM. CM
2205P	€ 199,00	Base con manico Base with handle	Polietilene Polyethylene	51x51	75x58x85 h
2206P	€ 171,00	Solo base Base only			58x58x19 h
2207P	€ 288,00	Base con manico Base with handle	Inox Stainless steel	51x51	61x52x95 h
2208P	€ 277,00	Solo base Base only			52x52x19 h
2202P	€ 299,00	Base con manico Base with handle	Inox Stainless steel	61x41	71x42x95 h
2203P	€ 285,00	Solo base Base only			62x42x19 h
1837	€ 101,00	Solo base Base only	Plastica Plastic	62x41	62x41x15,5 h

OPTIONAL	PREZZO / PRICE	DESCRIZIONE / DESCRIPTION	PER / FOR
F	€ 13,00	Set 2 ruote con freno Set with 2 braked castors	Tutti gli articoli All Articles (NO art. 1837)



- Struttura in tubo quadro di acciaio inox AISI 304 cm 2x2, traversi imbullonati
- Guide a "L" in lamiera inox
- Predisposto per cestello portabicchieri dim. cm 51x51
- Paracolpi in gomma grigia
- Ruote piroettanti ø cm 12,5i

- *AISI 304 stainless steel 2x2 cm square tube frame with bolted cross-members*
- *Stainless steel sheet "L"-shaped runners*
- *Suitable for dishwasher glass rack (dim. 51x51 cm)*
- *Grey rubber ring buffers*
- *Swivel castors, ø 12.5 cm*



Particolare guida

Runner detail



Art. 1498.5

ARTICOLO / ARTICLE	PREZZO / PRICE	GUIDE / RUNNER	CM DISTANZA SUPP / SHELF SPACING CM	MAX DIM. CM
1498.5	€ 363,00	5	30	64x60x184 h
1498.6	€ 387,00	6	26	
1498.7	€ 410,00	7	22	

OPTIONAL	PREZZO / PRICE	📷	DESCRIZIONE / DESCRIPTION	PER / FOR	
F	€ 28,00	1	Set 2 ruote con freno Set with 2 braked castors	Tutti gli articoli All Articles	
A0278	€ 230,00	-	Rivestimento in PVC con cerniere PVC cover with zipper		





PORTATEGLIE CON GUIDE IN FILO

CONTAINER TROLLEYS WITH WIRE RUNNERS

PAG. 30



PORTATEGLIE GN E CM 60X40

GN AND CM 60X40 CONTAINER TROLLEYS

PAG. 33



PORTAVASSOI GN ED EN

GN AND EN TRAY TROLLEYS

PAG. 36



PORTAVASSOI UNIVERSALI

UNIVERSAL TRAY TROLLEYS

PAG. 42

PORTATEGLIE GN CON GUIDE IN FILO GN CONTAINER TROLLEYS WITH WIRE RUNNERS

- Struttura in tubo quadro di acciaio inox AISI 304 cm 2x2, traversi imbullonati
- Guide in filo di acciaio inox
- Adatti ad ospitare vassoi e teglie GN
- Piano superiore inox (Art. 2080 - 2082)
- Paracolpi in gomma grigia (Art. 2090 - 2092)
- Ruote piroettanti ø cm 9,5 (Art. 2080 - 2082) o ø cm 12,5 (Art. 2090 - 2092)



- *AISI 304 stainless steel 2x2 cm square tube construction with bolted cross-members*
- *Stainless steel wire supports*
- *Suitable for GN trays and containers*
- *Stainless steel top (Art. 2080 - 2082)*
- *Grey rubber ring buffers (Art. 2090 - 2092)*
- *Swivel castors - ø 9.5 cm (Art. 2080 - 2082) or ø 12.5 cm (Art. 2090 - 2092)*



Art. 2080-F

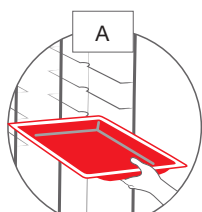

INSERIMENTO
VASSOI-TEGLIE 1/1 GN
PER IL LATO CORTO

1/1 GN
TRAYS-CONTAINERS
SHORT-SIDE LOADING



Art. 2092

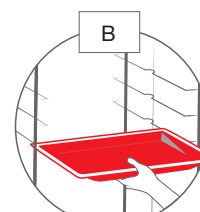

INSERIMENTO
VASSOI-TEGLIE 2/1 GN
PER IL LATO CORTO

2/1 GN
TRAYS-CONTAINERS
LONG-SIDE LOADING

ARTICOLO / ARTICLE	PREZZO / PRICE	PORT. VASSOI-TEGLIE / CONTAINER-TRAY CAP	SUPPORTO / RUNNERS	PASSO CM / SHELF SPACING	MAX DIM. CM
2080	€ 434,00	9 GN 1/1	In filo Wire		42x59x87 h
2082	€ 475,00	9 GN 2/1			62x69x87 h
2090	€ 643,00	20 GN 1/1			47x63x181 h
2092	€ 684,00	20 GN 2/1			67x73x181 h

OPTIONAL	PREZZO / PRICE	QUANTITÀ	DESCRIZIONE / DESCRIPTION	PER / FOR	IMMAGINE
F	€ 13,00	1	Set 2 ruote con freno Set with 2 braked castors	2080 - 2082	
F	€ 28,00	2		2090 - 2092	

ACCESSORI / ACCESSORIES	PREZZO / PRICE	QUANTITÀ	DESCRIZIONE / DESCRIPTION	PER / FOR	IMMAGINE
A0170	€ 47,00	3	Griglia in filo inox 1/1 GN 1/1 GN stainless steel wire shelf	2080 - 2082	
A0171	€ 76,00	4	Griglia in filo inox 2/1 GN 2/1 GN stainless steel wire shelf	2090 - 2092	

PORTATEGLIE GN CON GUIDE A "C"
GN CONTAINER TROLLEYS - "C"- SHAPED RUNNERS



- Struttura in tubo quadro di acciaio inox AISI 304 cm 2x2, traversi imbullonati
- Guide antiribaltamento a "C" in lamiera inox
- Adatti ad ospitare teglie GN
- Piano superiore inox (Art. 2073 - 2074 - 2073D)
- Paracolpi in gomma grigia
- Ruote piroettanti ø cm 9,5 (Art. 2073 - 2074 - 2073D) o ø cm 12,5 (Art. 2070 - 2071 - 2072)

- AISI 304 stainless steel 2x2 cm square tube construction with bolted cross-members
- "C"-shaped stainless steel sheet runners to prevent containers from overturning
- Suitable for GN containers
- Stainless steel top (Art. 2073 - 2074 - 2073D)
- Grey rubber ring buffers
- Swivel castors ø cm 9.5 (Art. 2073 - 2074 - 2073D) or ø cm 12.5 (Art. 2070 - 2071 - 2072)



Art. 2071



Art. 2072-F



Art. 2073D

ARTICOLO / ARTICLE	PREZZO / PRICE	PORT. TEGLIE / CONTAINER CAP	SUPPORTO / RUNNERS	PASSO CM / SHELF SPACING	MAX DIM. CM
2073	€ 411,00	8 GN 1/1	C	 7,5	44x60x85 h
2074	€ 455,00	8 GN 2/1			65x72x85 h
2073D	€ 665,00	8+8 GN 1/1			80x60x89 h
2070	€ 477,00	14 GN 1/1		8,5	44x60x163 h
2071	€ 564,00	18 GN 1/1		7,5	44x60x176 h
2072	€ 545,00	14 GN 2/1		8,5	65x72x163 h

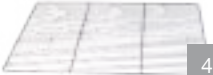
OPTIONAL	PREZZO / PRICE	QUANTITÀ	DESCRIZIONE / DESCRIPTION	PER / FOR	IMMAGINE
F	€ 13,00	1	Set 2 ruote con freno Set with 2 braked castors	2073 - 2074 2073D	 
F	€ 28,00	2		2070 - 2071 2072	
ACCESSORI / ACCESSORIES	PREZZO / PRICE	QUANTITÀ	DESCRIZIONE / DESCRIPTION	PER / FOR	IMMAGINE
A0170	€ 47,00	3	Griglia in filo inox 1/1 GN 1/1 GN stainless steel wire shelf	2070 - 2071 2073 - 2073D	
A0171	€ 76,00	4	Griglia in filo inox 2/1 GN 2/1 GN stainless steel wire shelf	2072 - 2074	

PORTATEGLIE GN CON GUIDE A "C"
GN CONTAINER TROLLEYS - "C"- SHAPED RUNNERS



- Struttura in tubo quadro di acciaio inox AISI 304 cm 2,5x2,5, traversi imbullonati
 - Guide antiribaltamento a "C" in lamiera inox, con fermo di fine corsa
 - Adatti ad ospitare teglie GN
 - Versione "S" con struttura, traversi e alette completamente saldati
 - Paracolpi in gomma grigia
 - Ruote piroettanti ø cm 12,5
- *AISI 304 stainless steel 2,5x2,5 cm square tube construction with bolted cross-members*
 - *"C"-shaped stainless steel sheet runners with end stops to prevent containers from sliding and overturning*
 - *Suitable for GN containers*
 - *"S" version with welded structure, crosspieces and flaps*
 - *Grey rubber ring buffers*
 - *Swivel castors, ø 12.5 cm*



Art. 2062-F



Art. 2060-F

ARTICOLO / ARTICLE	PREZZO / PRICE	PORT. TEGLIE / CONTAINER CAP	SUPPORTO / RUNNERS	PASSO CM / SHELF SPACING		MAX DIM. CM
2060	€ 724,00	18 GN 2/1			Smontato / Unassembled	65x73x180 h
2060S	€ 818,00				Saldato / Welded	
2062	€ 660,00	18 GN 1/1			Smontato / Unassembled	45x61x180 h
2062S	€ 745,00				Saldato / Welded	

OPTIONAL	PREZZO / PRICE		DESCRIZIONE / DESCRIPTION	PER / FOR	
F	€ 28,00	1	Set 2 ruote con freno Set with 2 braked castors	Tutti gli articoli All Articles	1

ACCESSORI / ACCESSORIES	PREZZO / PRICE		DESCRIZIONE / DESCRIPTION	PER / FOR	
A0170	€ 47,00	2	Griglia in filo inox 1/1 GN 1/1 GN stainless steel wire shelf	2062 - 2062S	2
A0171	€ 76,00	3	Griglia in filo inox 2/1 GN 2/1 GN stainless steel wire shelf	2060 - 2060S	3

PORTATEGLIE cm 60x40 CON GUIDE A "L"
TROLLEYS FOR CONTAINERS 60x40 cm - "L"- SHAPED RUNNERS

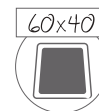

- Struttura in tubo quadro di acciaio inox AISI 304 cm 2x2, traversi imbullonati
 - Guide a "L" in lamiera inox
 - Adatti ad ospitare teglie cm 60x40
 - Piano superiore inox (Art. 2078)
 - Paracolpi in gomma grigia
 - Ruote piroettanti ø cm 9,5 (Art. 2078) o ø cm 12,5 (Art. 2076 - 2077)
- *AISI 304 stainless steel 2x2 cm square tube construction with bolted cross-members*
 - *Stainless steel "L"-shaped runners*
 - *Suitable for 60x40 cm containers*
 - *Stainless steel top (Art. 2078)*
 - *Grey rubber ring buffers*
 - *Swivel castors - ø 9.5 cm (Art. 2078) or ø 12.5 cm (Art. 2076 - 2077)*





Art. 2078



Art. 2076-F

ARTICOLO / ARTICLE	PREZZO / PRICE	PORT. TEGLIE / CONTAINER CAP	SUPPORTO / RUNNERS	PASSO CM / SHELF SPACING	MAX DIM. CM
2078	€ 425,00	8	L	7.5	52x72x85 h
2076	€ 510,00	14		8.5	52x72x163 h
2077	€ 564,00	18		7.5	52x72x176 h

OPTIONAL	PREZZO / PRICE	QUANTITÀ	DESCRIZIONE / DESCRIPTION	PER / FOR	IMMAGINE
F	€ 13,00	1	Set 2 ruote con freno Set with 2 braked castors	2078	
F	€ 28,00	2		2076 - 2077	

PORTATEGLIE cm 60x40 CON GUIDE A "L"





TROLLEYS FOR CONTAINERS 60x40 cm - "L"- SHAPED RUNNERS



- Struttura in tubo quadro di acciaio inox AISI 304 cm 2,5x2,5, traversi imbullonati
 - Guide a "L" in lamiera inox, con fermo di fine corsa
 - Adatti ad ospitare teglie cm 60x40
 - Versione "S" con struttura, traversi e alette completamente saldati
 - Paracolpi in gomma grigia
 - Ruote piroettanti ø cm 12,5
- *AISI 304 stainless steel 2.5x2.5 cm square tube construction with bolted cross-members*
 - *Stainless steel "L"-shaped runners with end stops*
 - *Suitable for 60x40 cm containers*
 - *"S" version with welded structure, crosspieces and flaps*
 - *Grey rubber ring buffers*
 - *Swivel castors, ø 12.5 cm*



Art. 2066-F

ARTICOLO / ARTICLE	PREZZO / PRICE	PORT. TEGLIE / CONTAINER CAP	SUPPORTO / RUNNERS	PASSO CM / SHELF SPACING		MAX DIM. CM
2066	€ 679,00	18			Smontato / Unassembled	53x68x172 h
2066S	€ 774,00				Saldato / Welded	
OPTIONAL	PREZZO / PRICE		DESCRIZIONE / DESCRIPTION		PER / FOR	
F	€ 28,00	1	Set 2 ruote con freno Set with 2 braked castors		Tutti gli articoli All Articles	

- Struttura in tubo quadro di acciaio inox cm 3,5x3,5, traversi imbullonati
 - Supporti in tubo di acciaio inox ø cm 1,4
 - Adatti ad ospitare teglie cm 60x40
 - Ruote piroettanti ø cm 12,5
- *Stainless steel 3.5x3.5 cm square tube construction with bolted cross-members*
 - *Stainless steel tubular supports - ø 1.4 cm*
 - *Suitable for 60x40 cm containers*
 - *Swivel castors, ø 12.5 cm*

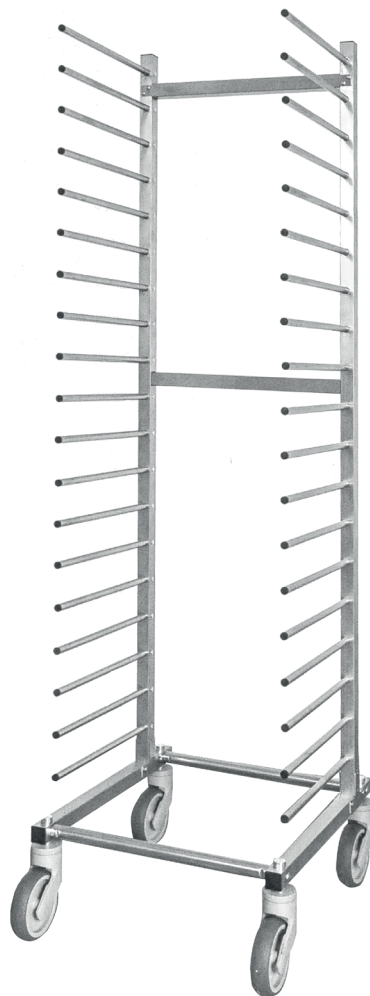
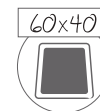

Art. 1497G

ARTICOLO / ARTICLE	PREZZO / PRICE	PORT. TEGLIE / CONTAINER CAP	SUPPORTO / RUNNERS	PASSO CM / SHELF SPACING	MAX DIM. CM
1497G	€ 708,00	20	Tubo / Tube	8	54x55x176 h
OPTIONAL	PREZZO / PRICE		DESCRIZIONE / DESCRIPTION	PER / FOR	
F	€ 28,00	1	Set 2 ruote con freno Set with 2 braked castors	Tutti gli articoli All Articles	 1

PORTAVASSOI GN - EN GN / EN TRAY TROLLEYS

- Struttura in tubo quadro di acciaio inox AISI 304 cm 2,5x2,5, traversi imbullonati
 - Guide ad "L" in lamiera inox
 - Paracolpi in gomma grigia
 - Ruote piroettanti ø cm 12,5
- AISI 304 stainless steel 2.5x2.5 cm square tube construction with bolted cross-members
 - Stainless steel sheet "L"-shaped runners
 - Grey rubber ring buffers
 - Swivel castors, ø 12.5 cm

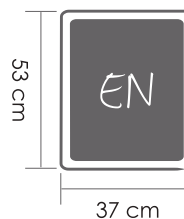
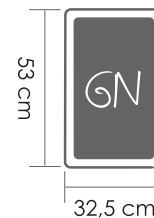

INDICATO PER VASSOI GN/EN
E VASSOI EUROTHERM
SUITABLE FOR GN/EN
AND EUROTHERM TRAYS

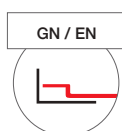

Art. 1494-GN-F

ARTICOLO / ARTICLE	PREZZO / PRICE	PORT. VASSOI / TRAY CAP	SUPPORTO / RUNNERS	PASSO CM / SHELF SPACING	MAX DIM. CM
1494-GN	€ 512,00	12 GN 1/1	L	12	45x60x190 h
1495-GN	€ 789,00	24 GN 1/1			81x60x190 h
1494-EN	€ 512,00	12 EN			50x60x190 h
1495-EN	€ 789,00	24 EN			90x60x190 h

OPTIONAL	PREZZO / PRICE	QUANTITÀ	DESCRIZIONE / DESCRIPTION	PER / FOR
F	€ 28,00	1	Set 2 ruote con freno Set with 2 braked castors	Tutti gli articoli All Articles
E	€ 200,00	2	Set 4 ruote elastiche, di cui 2 con freno, per pavimenti sconnessi o per esterno Set with 4 resilient castors, 2 with brake, for uneven floors / outdoor use	

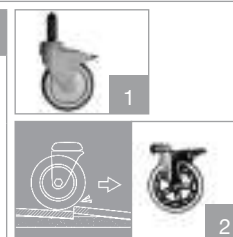

ACCESSORI / ACCESSORIES	PREZZO / PRICE	QUANTITÀ	DESCRIZIONE / DESCRIPTION	PER / FOR
A050GN	€ 75,00	3	Bacinella estraibile in acciaio inox 1 per ogni colonna Removable stainless steel container 1 for each column	Tutti GN GN models
A050EN	€ 75,00			Tutti EN EN models



- Struttura in tubo quadro di acciaio inox AISI 304 cm 2x2, trasversi imbullonati
 - Guide a "L" in lamiera inox adatte ad ospitare vassoi GN o EN (a seconda del modello)
 - Paracolpi in gomma grigia
 - Ruote piroettanti ø cm 12,5
- *AISI 304 stainless steel 2x2 cm square tube construction with bolted cross-members*
 - *Stainless steel sheet "L"-shaped runners suitable for GN or EN trays (depending on the model)*
 - *Grey rubber ring buffers*
 - *Swivel castors, ø 12.5 cm*

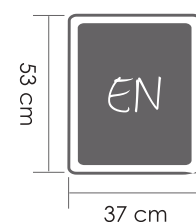
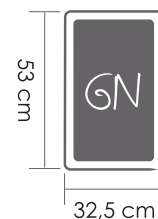

Art. 1475GN

ARTICOLO / ARTICLE	PREZZO / PRICE	PORT. VASSOI / TRAY CAP	SUPPORTO / RUNNERS	PASSO CM / SHELF SPACING	MAX DIM. CM
1470GN	€ 385,00	10 GN 1/1	L	11	45x60x150 h
1472GN	€ 424,00	12 GN 1/1			45x60x172 h
1475GN	€ 586,00	20 GN 1/1			80x60x150 h
1477GN	€ 646,00	24 GN 1/1			80x60x172 h
1480GN	€ 777,00	30 GN 1/1			116x60x150 h
1482GN	€ 870,00	36 GN 1/1			116x60x172 h
1470EN	€ 385,00	10 EN			49x60x150 h
1472EN	€ 424,00	12 EN			49x60x172 h
1475EN	€ 586,00	20 EN			89x60x150 h
1477EN	€ 646,00	24 EN			89x60x172 h
1480EN	€ 777,00	30 EN			129x60x150 h
1482EN	€ 870,00	36 EN			129x60x172 h

OPTIONAL	PREZZO / PRICE	DESCRIZIONE / DESCRIPTION	PER / FOR
F	€ 28,00	Set 2 ruote con freno Set with 2 braked castors	Tutti gli articoli All Articles
E	€ 200,00	Set 4 ruote elastiche, di cui 2 con freno, per pavimenti sconnessi o per esterno Set with 4 resilient castors, 2 with brake, for uneven floors / outdoor use	
ACCESSORI / ACCESSORIES	PREZZO / PRICE	DESCRIZIONE / DESCRIPTION	PER / FOR
A050GN	€ 75,00	Bacinella estraibile in acciaio inox 1 per ogni colonna Removable stainless steel container 1 for each column	Tutti GN GN models
A050EN	€ 75,00		Tutti EN EN models



PORTAVASSOI GN - EN CON PANNELLI IN ACCIAIO INOX AISI 304 GN - EN TRAY TROLLEYS WITH AISI 304 STAINLESS STEEL PANELS

- Struttura in tubo quadro di acciaio inox AISI 304 cm 2x2, traversi imbullonati
- Guide a "L" in lamiera inox adatte ad ospitare vassoi GN o EN (a seconda del modello)
- Pannelli in lamiera di acciaio inox AISI 304
- Paracolpi in gomma grigia
- Ruote piroettanti ø cm 12,5

Acciaio
Stainless steel



- AISI 304 stainless steel 2x2 cm square tube construction with bolted cross-members
- Stainless steel sheet "L"-shaped runners suitable for GN or EN trays (depending on the model)
- AISI 304 stainless steel sheet panels
- Grey rubber ring buffers
- Swivel castors, ø 12.5 cm

PORTAVASSOI GN - EN CON PANNELLI SU 2 LATI GN - EN TRAY TROLLEYS WITH PANELS ON 2 SIDES



Art. 1470GN-PI

ARTICOLO / ARTICLE	PREZZO / PRICE	PORT. VASSOI / TRAY CAP	SUPPORTO / RUNNERS	PASSO CM / SHELF SPACING	MAX DIM. CM
1470GN-PI	€ 552,00	10 GN 1/1	L	11	45x60x150 h
1472GN-PI	€ 615,00	12 GN 1/1			45x60x172 h
1475GN-PI	€ 752,00	20 GN 1/1			80x60x150 h
1477GN-PI	€ 837,00	24 GN 1/1			80x60x172 h
1480GN-PI	€ 945,00	30 GN 1/1			116x60x150 h
1482GN-PI	€ 1.062,00	36 GN 1/1			116x60x172 h
1470EN-PI	€ 552,00	10 EN			49x60x150 h
1472EN-PI	€ 615,00	12 EN			49x60x172 h
1475EN-PI	€ 752,00	20 EN			89x60x150 h
1477EN-PI	€ 837,00	24 EN			89x60x172 h
1480EN-PI	€ 945,00	30 EN			129x60x150 h
1482EN-PI	€ 1.062,00	36 EN			129x60x172 h

PORTAVASSOI GN - EN CON PANNELLI SU 3 LATI - RIPIANO SUPERIORE CON RINGHIERINO GN - EN TRAY TROLLEYS WITH PANELS ON 3 SIDES - TOP SHELF WITH RAILS



Art. 1476GN

ARTICOLO / ARTICLE	PREZZO / PRICE	PORT. VASSOI / TRAY CAP	SUPPORTO / RUNNERS	PASSO CM / SHELF SPACING	MAX DIM. CM
1471GN	€ 709,00	10 GN 1/1	L	11	45x60x150 h
1474GN	€ 787,00	12 GN 1/1			45x60x172 h
1476GN	€ 1.029,00	20 GN 1/1			80x60x150 h
1478GN	€ 1.144,00	24 GN 1/1			80x60x172 h
1481GN	€ 1.341,00	30 GN 1/1			116x60x150 h
1483GN	€ 1.502,00	36 GN 1/1			116x60x172 h
1471EN	€ 709,00	10 EN			49x60x150 h
1474EN	€ 787,00	12 EN			49x60x172 h
1476EN	€ 1.029,00	20 EN			89x60x150 h
1478EN	€ 1.144,00	24 EN			89x60x172 h
1481EN	€ 1.341,00	30 EN			129x60x150 h
1483EN	€ 1.502,00	36 EN			129x60x172 h

OPTIONAL	PREZZO / PRICE	Q	DESCRIZIONE / DESCRIPTION	PER / FOR
F	€ 28,00	1	Set 2 ruote con freno Set with 2 braked castors	Tutti gli articoli All Articles
E	€ 200,00	2	Set 4 ruote elastiche, di cui 2 con freno, per pavimenti sconnessi o per esterno Set with 4 resilient castors, 2 with brake, for uneven floors / outdoor use	
A050GN	€ 75,00	3	Bacinella estraibile in acciaio inox 1 per ogni colonna Removable stainless steel container 1 for each column	Tutti GN pannellati su 2 lati GN models with panels on 2 sides
A050EN	€ 75,00			Tutti EN pannellati su 2 lati EN models with panels on 2 sides

PORTAVASSOI GN - EN - PANNELLI COLOR ROVERE
GN - EN TRAY TROLLEYS - OAK STAINED PANELS

- Struttura in tubo quadro di acciaio inox AISI 304 cm 2x2, traversi imbullonati
- Guide a "L" in lamiera inox adatte ad ospitare vassoi GN o EN (a seconda del modello)
- Pannelli in nobilitato color rovere
- Paracolpi in gomma grigia
- Ruote piroettanti ø cm 12,5

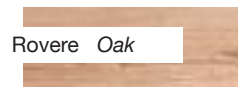

- AISI 304 stainless steel 2x2 cm square tube construction with bolted cross-members
- Stainless steel sheet "L"-shaped runners suitable for GN or EN trays (depending on the model)
- Oak stained melamine-faced panels
- Grey rubber ring buffers
- Swivel castors, ø 12.5 cm

PORTAVASSOI GN - EN CON PANNELLI SU 2 LATI
GN - EN TRAY TROLLEYS WITH PANELS ON 2 SIDES



Art. 1475GN-PN

ARTICOLO / ARTICLE	PREZZO / PRICE	PORT. VASSOI / TRAY CAP	SUPPORTO / RUNNERS	PASSO CM / SHELF SPACING	MAX DIM. CM
1470GN-PN	€ 567,00	10 GN 1/1	L	11	45x60x150 h
1472GN-PN	€ 631,00	12 GN 1/1			45x60x172 h
1475GN-PN	€ 792,00	20 GN 1/1			80x60x150 h
1477GN-PN	€ 879,00	24 GN 1/1			80x60x172 h
1480GN-PN	€ 1.004,00	30 GN 1/1			116x60x150 h
1482GN-PN	€ 1.127,00	36 GN 1/1			116x60x172 h
1470EN-PN	€ 567,00	10 EN			49x60x150 h
1472EN-PN	€ 631,00	12 EN			49x60x172 h
1475EN-PN	€ 792,00	20 EN			89x60x150 h
1477EN-PN	€ 879,00	24 EN			89x60x172 h
1480EN-PN	€ 1.004,00	30 EN			129x60x150 h
1482EN-PN	€ 1.127,00	36 EN			129x60x172 h

PORTAVASSOI GN - EN CON PANNELLI SU 3 LATI - RIPIANO SUPERIORE CON RINGHIERINO
GN - EN TRAY TROLLEYS WITH PANELS ON 3 SIDES - TOP SHELF WITH RAILS



Art. 1476SGN-F

ARTICOLO / ARTICLE	PREZZO / PRICE	PORT. VASSOI / TRAY CAP	SUPPORTO / RUNNERS	PASSO CM / SHELF SPACING	MAX DIM. CM
1471SGN	€ 698,00	10 GN 1/1	L	11	45x60x150 h
1474SGN	€ 769,00	12 GN 1/1			45x60x172 h
1476SGN	€ 1.023,00	20 GN 1/1			80x60x150 h
1478SGN	€ 1.127,00	24 GN 1/1			80x60x172 h
1481SGN	€ 1.336,00	30 GN 1/1			116x60x150 h
1483SGN	€ 1.484,00	36 GN 1/1			116x60x172 h
1471SEN	€ 698,00	10 EN			49x60x150 h
1474SEN	€ 769,00	12 EN			49x60x172 h
1476SEN	€ 1.023,00	20 EN			89x60x150 h
1478SEN	€ 1.127,00	24 EN			89x60x172 h
1481SEN	€ 1.336,00	30 EN			129x60x150 h
1483SEN	€ 1.484,00	36 EN			129x60x172 h

OPTIONAL	PREZZO / PRICE	DESCRIZIONE / DESCRIPTION	PER / FOR
F	€ 28,00	Set 2 ruote con freno Set with 2 braked castors	Tutti gli articoli All Articles
E	€ 200,00	Set 4 ruote elastiche, di cui 2 con freno, per pavimenti sconnessi o per esterno Set with 4 resilient castors, 2 with brake, for uneven floors / outdoor use	
ACCESSORI / ACCESSORIES	PREZZO / PRICE	DESCRIZIONE / DESCRIPTION	PER / FOR
A050GN	€ 75,00	Bacinella estraibile in acciaio inox 1 per ogni colonna Removable stainless steel container 1 for each column	Tutti GN pannellati su 2 lati GN models with panels on 2 sides
A050EN	€ 75,00		Tutti EN pannellati su 2 lati EN models with panels on 2 sides

PORTAVASSOI GN - EN - PANNELLI COLOR ROVERE TABACCO GN - EN TRAY TROLLEYS - TOBACCO OAK STAINED PANELS

- Struttura in tubo quadro di acciaio inox AISI 304 cm 2x2, traversi imbullonati
- Guide a "L" in lamiera inox adatte ad ospitare vassoi GN o EN (a seconda del modello)
- Pannelli in nobilitato color rovere tabacco
- Paracolpi in gomma grigia
- Ruote piroettanti ø cm 12,5

Rovere Tabacco
Tobacco Oak



- AISI 304 stainless steel 2x2 cm square tube construction with bolted cross-members
- Stainless steel sheet "L"-shaped runners suitable for GN or EN trays (depending on the model)
- Tobacco oak stained melamine-faced panels
- Grey rubber ring buffers
- Swivel castors, ø 12.5 cm

PORTAVASSOI GN - EN CON PANNELLI SU 2 LATI GN - EN TRAY TROLLEYS WITH PANELS ON 2 SIDES



Art. 1475GN-PNT



ARTICOLO / ARTICLE	PREZZO / PRICE	PORT. VASSOI / TRAY CAP	SUPPORTO / RUNNERS	PASSO CM / SHELF SPACING	MAX DIM. CM
1470GN-PNT	€ 584,00	10 GN 1/1	L	11	45x60x150 h
1472GN-PNT	€ 651,00	12 GN 1/1			45x60x172 h
1475GN-PNT	€ 807,00	20 GN 1/1			80x60x150 h
1477GN-PNT	€ 898,00	24 GN 1/1			80x60x172 h
1480GN-PNT	€ 1.021,00	30 GN 1/1			116x60x150 h
1482GN-PNT	€ 1.145,00	36 GN 1/1			116x60x172 h
1470EN-PNT	€ 584,00	10 EN			49x60x150 h
1472EN-PNT	€ 651,00	12 EN			49x60x172 h
1475EN-PNT	€ 807,00	20 EN			89x60x150 h
1477EN-PNT	€ 898,00	24 EN			89x60x172 h
1480EN-PNT	€ 1.021,00	30 EN			129x60x150 h
1482EN-PNT	€ 1.145,00	36 EN			129x60x172 h

PORTAVASSOI GN - EN CON PANNELLI SU 3 LATI - RIPIANO SUPERIORE CON RINGHIERINO GN - EN TRAY TROLLEYS WITH PANELS ON 3 SIDES - TOP SHELF WITH RAILS



Art. 1476SGNT-F

ARTICOLO / ARTICLE	PREZZO / PRICE	PORT. VASSOI / TRAY CAP	SUPPORTO / RUNNERS	PASSO CM / SHELF SPACING	MAX DIM. CM
1471SGNT	€ 732,00	10 GN 1/1	L	11	45x60x150 h
1474SGNT	€ 806,00	12 GN 1/1			45x60x172 h
1476SGNT	€ 1.069,00	20 GN 1/1			80x60x150 h
1478SGNT	€ 1.174,00	24 GN 1/1			80x60x172 h
1481SGNT	€ 1.394,00	30 GN 1/1			116x60x150 h
1483SGNT	€ 1.545,00	36 GN 1/1			116x60x172 h
1471SENT	€ 732,00	10 EN			49x60x150 h
1474SENT	€ 806,00	12 EN			49x60x172 h
1476SENT	€ 1.069,00	20 EN			89x60x150 h
1478SENT	€ 1.174,00	24 EN			89x60x172 h
1481SENT	€ 1.394,00	30 EN			129x60x150 h
1483SENT	€ 1.545,00	36 EN			129x60x172 h

OPTIONAL	PREZZO / PRICE	Q	DESCRIZIONE / DESCRIPTION	PER / FOR	
F	€ 28,00	1	Set 2 ruote con freno Set with 2 braked castors	Tutti gli articoli All Articles	
E	€ 200,00	2	Set 4 ruote elastiche, di cui 2 con freno, per pavimenti sconnessi o per esterno Set with 4 resilient castors, 2 with brake, for uneven floors / outdoor use		
A050GN	€ 75,00	3	Bacinella estraibile in acciaio inox 1 per ogni colonna Removable stainless steel container 1 for each column	Tutti GN pannellati su 2 lati GN models with panels on 2 sides	
A050EN	€ 75,00			Tutti EN pannellati su 2 lati EN models with panels on 2 sides	

PORTAVASSOI GN - EN - PANNELLI COLOR BIANCO
GN - EN TRAY TROLLEYS - WHITE STAINED PANELS

- Struttura in tubo quadro di acciaio inox AISI 304 cm 2x2, traversi imbullonati
- Guide a "L" in lamiera inox adatte ad ospitare vassoi GN o EN (a seconda del modello)
- Pannelli in lamiera elettrozincata verniciata bianca
- Paracolpi in gomma grigia
- Ruote piroettanti ø cm 12,5

Bianco White



- AISI 304 stainless steel 2x2 cm square tube construction with bolted cross-members
- Stainless steel sheet "L"-shaped runners suitable for GN or EN trays (depending on the model)
- White painted electrogalvanized sheet metal
- Grey rubber ring buffers
- Swivel castors, ø 12.5 cm

PORTAVASSOI GN - EN CON PANNELLI SU 2 LATI
GN - EN TRAY TROLLEYS WITH PANELS ON 2 SIDES



Art. 1470GN-PNB



ARTICOLO / ARTICLE	PREZZO / PRICE	PORT. VASSOI / TRAY CAP	SUPPORTO / RUNNERS	PASSO CM / SHELF SPACING	MAX DIM. CM
1470GN-PNB	€ 525,00	10 GN 1/1	L	11	45x60x150 h
1472GN-PNB	€ 584,00	12 GN 1/1			45x60x172 h
1475GN-PNB	€ 733,00	20 GN 1/1			80x60x150 h
1477GN-PNB	€ 813,00	24 GN 1/1			80x60x172 h
1480GN-PNB	€ 929,00	30 GN 1/1			116x60x150 h
1482GN-PNB	€ 1.043,00	36 GN 1/1			116x60x172 h
1470EN-PNB	€ 525,00	10 EN			49x60x150 h
1472EN-PNB	€ 584,00	12 EN			49x60x172 h
1475EN-PNB	€ 733,00	20 EN			89x60x150 h
1477EN-PNB	€ 813,00	24 EN			89x60x172 h
1480EN-PNB	€ 929,00	30 EN			129x60x150 h
1482EN-PNB	€ 1.043,00	36 EN			129x60x172 h

PORTAVASSOI GN - EN CON PANNELLI SU 3 LATI - RIPIANO SUPERIORE CON RINGHIERINO
GN - EN TRAY TROLLEYS WITH PANELS ON 3 SIDES - TOP SHELF WITH RAILS



Art. 1476SENB-F

ARTICOLO / ARTICLE	PREZZO / PRICE	PORT. VASSOI / TRAY CAP	SUPPORTO / RUNNERS	PASSO CM / SHELF SPACING	MAX DIM. CM
1471SGNB	€ 646,00	10 GN 1/1	L	11	45x60x150 h
1474SGNB	€ 712,00	12 GN 1/1			45x60x172 h
1476SGNB	€ 947,00	20 GN 1/1			80x60x150 h
1478SGNB	€ 1.043,00	24 GN 1/1			80x60x172 h
1481SGNB	€ 1.237,00	30 GN 1/1			116x60x150 h
1483SGNB	€ 1.374,00	36 GN 1/1			116x60x172 h
1471SENB	€ 646,00	10 EN			49x60x150 h
1474SENB	€ 712,00	12 EN			49x60x172 h
1476SENB	€ 947,00	20 EN			89x60x150 h
1478SENB	€ 1.043,00	24 EN			89x60x172 h
1481SENB	€ 1.237,00	30 EN			129x60x150 h
1483SENB	€ 1.374,00	36 EN			129x60x172 h

OPTIONAL	PREZZO / PRICE	Q	DESCRIZIONE / DESCRIPTION	PER / FOR	
F	28,00	1	Set 2 ruote con freno Set with 2 braked castors	Tutti gli articoli All Articles	
E	200,00	2	Set 4 ruote elastiche, di cui 2 con freno, per pavimenti sconnessi o per esterno Set with 4 resilient castors, 2 with brake, for uneven floors / outdoor use		
ACCESSORI / ACCESSORIES	PREZZO / PRICE	Q	DESCRIZIONE / DESCRIPTION	PER / FOR	
A050GN	€ 75,00	3	Bacinella estraibile in acciaio inox 1 per ogni colonna Removable stainless steel container 1 for each column	Tutti GN pannellati su 2 lati GN models with panels on 2 sides	
A050EN	€ 75,00		Tutti EN pannellati su 2 lati EN models with panels on 2 sides		

PORTAVASSOI GN - EN - PANNELLI PERSONALIZZATI SU 2 LATI GN -EN TRAY TROLLEYS - CUSTOMIZED PANELS ON 2 SIDES

- Struttura in tubo quadro di acciaio inox AISI 304 cm 2x2, traversi imbullonati
- Guide a "L" in lamiera inox adatte ad ospitare vassoi GN o EN (a seconda del modello)
- Pannelli in lamiera elettrozincata verniciata bianca e PVC adesivo coprente, con stampa digitale resistente all'acqua e ai raggi UV, personalizzabile a piacere
- Paracolpi in gomma grigia
- Ruote piroettanti ø cm 12,5



- AISI 304 stainless steel 2x2 cm square tube construction with bolted cross-members
- Stainless steel sheet "L"-shaped runners suitable for GN or EN trays (depending on the model)
- White painted electrogalvanized sheet metal covered with adhesive PVC, with water-proof UV-resistant customizable digital print
- Grey rubber ring buffers
- Swivel castors, ø 12.5 cm

personalizzabile
customizable

Stampa digitale resistente all'acqua e ai raggi UV, personalizzata a piacere
NB: file da voi fornito.



Preventivo a richiesta

Customizable water-proof UV-resistant digital print
Please note: the file containing the image should be provided by you
Quotes upon request



Art. 1470GN-ADV-F + A050GN

ARTICOLO / ARTICLE	PREZZO / PRICE	PORT. VASSOI / TRAY CAP	SUPPORTO / RUNNERS	PASSO CM / SHELF SPACING	MAX DIM. CM
1470GN-ADV	€ 768,00	10 GN 1/1	L	11	45x60x150 h
1472GN-ADV	€ 849,00	12 GN 1/1			45x60x172 h
1475GN-ADV	€ 975,00	20 GN 1/1			80x60x150 h
1477GN-ADV	€ 1.078,00	24 GN 1/1			80x60x172 h
1480GN-ADV	€ 1.173,00	30 GN 1/1			116x60x150 h
1482GN-ADV	€ 1.308,00	36 GN 1/1			116x60x172 h
1470EN-ADV	€ 768,00	10 EN			49x60x150 h
1472EN-ADV	€ 849,00	12 EN			49x60x172 h
1475EN-ADV	€ 975,00	20 EN			89x60x150 h
1477EN-ADV	€ 1.078,00	24 EN			89x60x172 h
1480EN-ADV	€ 1.173,00	30 EN			129x60x150 h
1482EN-ADV	€ 1.308,00	36 EN			129x60x172 h

OPTIONAL	PREZZO / PRICE	QUANTITÀ	DESCRIZIONE / DESCRIPTION	PER / FOR	IMMAGINE
F	28,00	1	Set 2 ruote con freno Set with 2 braked castors	Tutti gli articoli All Articles	
E	200,00	2	Set 4 ruote elastiche, di cui 2 con freno, per pavimenti sconnessi o per esterno Set with 4 resilient castors, 2 with brake, for uneven floors / outdoor use		
ACCESSORI / ACCESSORIES	PREZZO / PRICE	QUANTITÀ	DESCRIZIONE / DESCRIPTION	PER / FOR	IMMAGINE
A050GN	€ 75,00	3	Bacinella estraibile in acciaio inox 1 per ogni colonna Removable stainless steel container 1 for each column	Tutti GN pannellati su 2 lati GN models with panels on 2 sides	
A050EN	€ 75,00		Tutti EN pannellati su 2 lati EN models with panels on 2 sides		

- Struttura in tubo quadro di acciaio inox AISI 304 cm 2x2, traversi imbullonati
 - Guide in filo di acciaio cromato adatte ad ospitare vassoi con dimensione massima di cm 53x39, anche di forme e dimensioni differenti fra loro
 - Paracolpi in gomma grigia
 - Ruote piroettanti ø cm 12,5
- *AISI 304 stainless steel 2x2 cm square tube construction with bolted cross-members*
 - *Chrome-plated steel wire supports suitable for trays having a maximum dimension of 53x39 cm even in different sizes and shapes*
 - *Grey rubber ring buffers*
 - *Swivel castors, ø 12.5 cm*

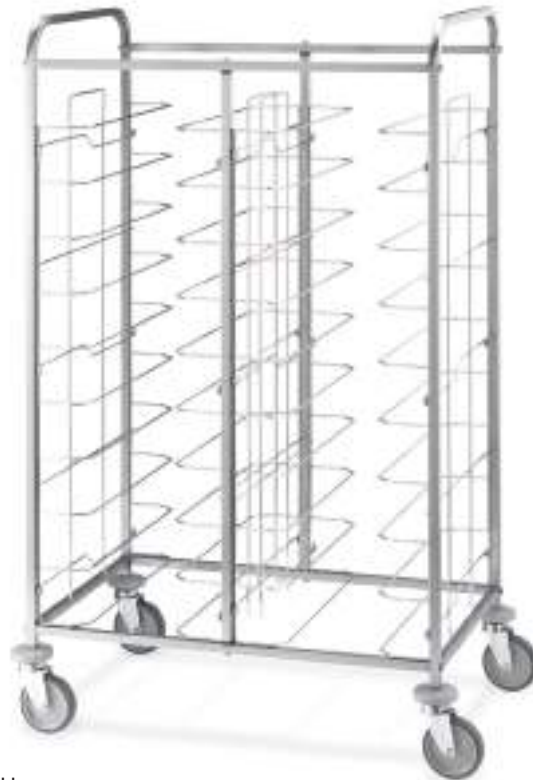
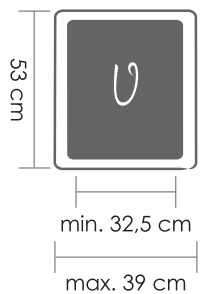
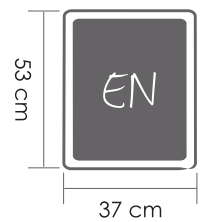
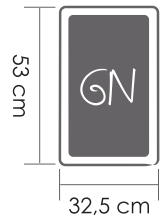

Art. 1475U

ARTICOLO / ARTICLE	PREZZO / PRICE	PORT. VASSOI / TRAY CAP	SUPPORTO / RUNNERS	PASSO CM / SHELF SPACING	MAX DIM. CM
1470U	€ 384,00	10 U	In filo Wire		52x60x159 h
1472U	€ 412,00	12 U			52x60x183 h
1475U	€ 573,00	20 U			95x60x159 h
1477U	€ 629,00	24 U			95x60x183 h
1480U	€ 760,00	30 U			138x60x159 h
1482U	€ 847,00	36 U			138x60x183 h

OPTIONAL	PREZZO / PRICE		DESCRIZIONE / DESCRIPTION	PER / FOR
F	€ 28,00	1	Set 2 ruote con freno Set with 2 braked castors	Tutti gli articoli All Articles
E	€ 200,00	2	Set 4 ruote elastiche, di cui 2 con freno, per pavimenti sconnessi o per esterno Set with 4 resilient castors, 2 with brake, for uneven floors / outdoor use	



ACCESSORI / ACCESSORIES	PREZZO / PRICE		DESCRIZIONE / DESCRIPTION	PER / FOR
A050U	€ 88,00	3	Bacinella estraibile in acciaio inox 1 per ogni colonna Removable stainless steel container 1 for each column	Tutti gli articoli All Articles

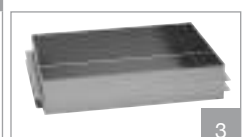

PORTAVASSOI UNIVERSALI CON PANNELLI IN ACCIAIO INOX AISI 304 UNIVERSAL TRAY TROLLEYS WITH AISI 304 STAINLESS STEEL PANELS

- Struttura in tubo quadro di acciaio inox AISI 304 cm 2x2, traversi imbullonati
- Guide in filo di acciaio cromato adatte ad ospitare vassoi con dimensione massima di cm 53x39, anche di forme e dimensioni differenti fra loro
- Pannelli in acciaio inox AISI 304
- Paracolpi in gomma grigia
- Ruote piroettanti ø cm 12,5

Acciaio
Stainless steel



- AISI 304 stainless steel 2x2 cm square tube construction with bolted cross-members
- Chrome-plated steel wire supports suitable for trays having a maximum dimension of 53x39 cm even in different sizes and shapes
- AISI 304 stainless steel panels
- Grey rubber ring buffers
- Swivel castors, ø 12.5 cm

PORTAVASSOI UNIVERSALI CON PANNELLI SU 2 LATI UNIVERSAL TRAY TROLLEYS WITH PANELS ON 2 SIDES



Art. 1475U-PI

ARTICOLO / ARTICLE	PREZZO / PRICE	PORT. VASSOI / TRAY CAP	SUPPORTO / RUNNERS	PASSO CM / SHELF SPACING	MAX DIM. CM
1470U-PI	€ 567,00	10 U	In filo Wire		52x60x159 h
1472U-PI	€ 621,00	12 U			52x60x183 h
1475U-PI	€ 758,00	20 U			95x60x159 h
1477U-PI	€ 840,00	24 U			95x60x183 h
1480U-PI	€ 943,00	30 U			138x60x159 h
1482U-PI	€ 1.057,00	36 U			138x60x183 h

PORTAVASSOI UNIVERSALI CON PANNELLI SU 3 LATI - RIPIANO SUPERIORE CON RINGHIERINO UNIVERSAL TRAY TROLLEYS WITH PANELS ON 3 SIDES - TOP SHELF WITH RAILS



Art. 1476U

ARTICOLO / ARTICLE	PREZZO / PRICE	PORT. VASSOI / TRAY CAP	SUPPORTO / RUNNERS	PASSO CM / SHELF SPACING	MAX DIM. CM
1471U	€ 735,00	10 U	In filo Wire		52x60x159 h
1474U	€ 806,00	12 U			52x60x183 h
1476U	€ 1.054,00	20 U			95x60x159 h
1478U	€ 1.168,00	24 U			95x60x183 h
1481U	€ 1.367,00	30 U			138x60x159 h
1483U	€ 1.529,00	36 U			138x60x183 h

OPTIONAL	PREZZO / PRICE	QUANTITÀ	DESCRIZIONE / DESCRIPTION	PER / FOR	IMMAGINE
F	€ 28,00	1	Set 2 ruote con freno Set with 2 braked castors	Tutti gli articoli All Articles	
E	€ 200,00	2	Set 4 ruote elastiche, di cui 2 con freno, per pavimenti sconnessi o per esterno Set with 4 resilient castors, 2 with brake, for uneven floors / outdoor use		
ACCESSORI / ACCESSORIES	PREZZO / PRICE	QUANTITÀ	DESCRIZIONE / DESCRIPTION	PER / FOR	IMMAGINE
A050U	€ 88,00	3	Bacinella estraibile in acciaio inox 1 per ogni colonna Removable stainless steel container 1 for each column	Tutti gli articoli pannellati su 2 lati All articles with panels on 2 sides	

PORTAVASSOI UNIVERSALI - PANNELLI COLOR ROVERE
UNIVERSAL TRAY TROLLEYS - OAK STAINED PANELS

- Struttura in tubo quadro di acciaio inox AISI 304 cm 2x2, traversi imbullonati
- Guide in filo di acciaio cromato adatte ad ospitare vassoi con dimensione massima di cm 53x39, anche di forme e dimensioni differenti fra loro
- Pannelli in nobilitato color rovere
- Paracolpi in gomma grigia
- Ruote piroettanti ø cm 12,5

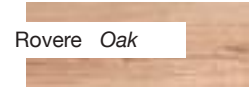

- AISI 304 stainless steel 2x2 cm square tube construction with bolted cross-members
- Chrome-plated steel wire supports suitable for trays having a maximum dimension of 53x39 cm even in different sizes and shapes
- Oak stained melamine-faced panels
- Grey rubber ring buffers
- Swivel castors, ø 12.5 cm

PORTAVASSOI UNIVERSALI CON PANNELLI SU 2 LATI
UNIVERSAL TRAY TROLLEYS WITH PANELS ON 2 SIDES



Art. 1470U-PN

ARTICOLO / ARTICLE	PREZZO / PRICE	PORT. VASSOI / TRAY CAP	SUPPORTO / RUNNERS	PASSO CM / SHELF SPACING	MAX DIM. CM
1470U-PN	€ 587,00	10 U	In filo Wire		52x60x159 h
1472U-PN	€ 639,00	12 U			52x60x183 h
1475U-PN	€ 802,00	20 U			95x60x159 h
1477U-PN	€ 887,00	24 U			95x60x183 h
1480U-PN	€ 1.012,00	30 U			138x60x159 h
1482U-PN	€ 1.132,00	36 U			138x60x183 h

PORTAVASSOI UNIVERSALI CON PANNELLI SU 3 LATI - RIPIANO SUPERIORE CON RINGHIERINO
UNIVERSAL TRAY TROLLEYS WITH PANELS ON 3 SIDES - TOP SHELF WITH RAILS



Art. 1471SU

ARTICOLO / ARTICLE	PREZZO / PRICE	PORT. VASSOI / TRAY CAP	SUPPORTO / RUNNERS	PASSO CM / SHELF SPACING	MAX DIM. CM
1471SU	€ 731,00	10 U	In filo Wire		52x60x159 h
1474SU	€ 791,00	12 U			52x60x183 h
1476SU	€ 1.053,00	20 U			95x60x159 h
1478SU	€ 1.157,00	24 U			95x60x183 h
1481SU	€ 1.374,00	30 U			138x60x159 h
1483SU	€ 1.523,00	36 U			138x60x183 h

OPTIONAL	PREZZO / PRICE	QUANTITÀ	DESCRIZIONE / DESCRIPTION	PER / FOR
F	€ 28,00	1	Set 2 ruote con freno Set with 2 braked castors	Tutti gli articoli All Articles
E	€ 200,00	2	Set 4 ruote elastiche, di cui 2 con freno, per pavimenti sconnessi o per esterno Set with 4 resilient castors, 2 with brake, for uneven floors / outdoor use	
ACCESSORI / ACCESSORIES	PREZZO / PRICE	QUANTITÀ	DESCRIZIONE / DESCRIPTION	PER / FOR
A050U	€ 88,00	3	Bacinella estraibile in acciaio inox 1 per ogni colonna Removable stainless steel container 1 for each column	Tutti gli articoli pannellati su 2 lati All articles with panels on 2 sides

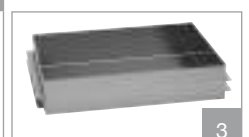

PORTAVASSOI UNIVERSALI - PANNELLI COLOR ROVERE TABACCO
UNIVERSAL TRAY TROLLEYS - TOBACCO OAK STAINED PANELS

- Struttura in tubo quadro di acciaio inox AISI 304 cm 2x2, traversi imbullonati
- Guide in filo di acciaio cromato adatte ad ospitare vassoi con dimensione massima di cm 53x39, anche di forme e dimensioni differenti fra loro
- Pannelli in nobilitato color rovere tabacco
- Paracolpi in gomma grigia
- Ruote piroettanti ø cm 12,5

Rovere Tabacco
Tobacco Oak



- *AISI 304 stainless steel 2x2 cm square tube construction with bolted cross-members*
- *Chrome-plated steel wire supports suitable for trays having a maximum dimension of 53x39 cm even in different sizes and shapes*
- *Tobacco oak stained melamine-faced panels*
- *Grey rubber ring buffers*
- *Swivel castors, ø 12.5 cm*

PORTAVASSOI UNIVERSALI CON PANNELLI SU 2 LATI
UNIVERSAL TRAY TROLLEYS WITH PANELS ON 2 SIDES



Art. 1470U-PNT-F + A050U

ARTICOLO / ARTICLE	PREZZO / PRICE	PORT. VASSOI / TRAY CAP	SUPPORTO / RUNNERS	PASSO CM / SHELF SPACING	MAX DIM. CM
1470U-PNT	€ 610,00	10 U	In filo Wire		52x60x159 h
1472U-PNT	€ 665,00	12 U			52x60x183 h
1475U-PNT	€ 823,00	20 U			95x60x159 h
1477U-PNT	€ 912,00	24 U			95x60x183 h
1480U-PNT	€ 1.034,00	30 U			138x60x159 h
1482U-PNT	€ 1.158,00	36 U			138x60x183 h

PORTAVASSOI UNIVERSALI CON PANNELLI SU 3 LATI - RIPIANO SUPERIORE CON RINGHIERINO
UNIVERSAL TRAY TROLLEYS WITH PANELS ON 3 SIDES - TOP SHELF WITH RAILS



Art. 1476SUT-F

ARTICOLO / ARTICLE	PREZZO / PRICE	PORT. VASSOI / TRAY CAP	SUPPORTO / RUNNERS	PASSO CM / SHELF SPACING	MAX DIM. CM
1471SUT	€ 775,00	10 U	In filo Wire		52x60x159 h
1474SUT	€ 841,00	12 U			52x60x183 h
1476SUT	€ 1.116,00	20 U			95x60x159 h
1478SUT	€ 1.224,00	24 U			95x60x183 h
1481SUT	€ 1.450,00	30 U			138x60x159 h
1483SUT	€ 1.609,00	36 U			138x60x183 h

OPTIONAL	PREZZO / PRICE		DESCRIZIONE / DESCRIPTION	PER / FOR	
F	€ 28,00	1	Set 2 ruote con freno Set with 2 braked castors	Tutti gli articoli All Articles	
E	€ 200,00	2	Set 4 ruote elastiche, di cui 2 con freno, per pavimenti sconnessi o per esterno Set with 4 resilient castors, 2 with brake, for uneven floors / outdoor use		
ACCESSORI / ACCESSORIES	PREZZO / PRICE		DESCRIZIONE / DESCRIPTION	PER / FOR	
A050U	€ 88,00	3	Bacinella estraibile in acciaio inox 1 per ogni colonna Removable stainless steel container 1 for each column	Tutti gli articoli pannellati su 2 lati All articles with panels on 2 sides	

PORTAVASSOI UNIVERSALI - PANNELLI COLOR BIANCO
UNIVERSAL TRAY TROLLEYS - WHITE STAINED PANELS

- Struttura in tubo quadro di acciaio inox AISI 304 cm 2x2, traversi imbullonati
- Guide in filo di acciaio cromato adatte ad ospitare vassoi con dimensione massima di cm 53x39, anche di forme e dimensioni differenti fra loro
- Pannelli in lamiera elettrozincata verniciata bianca
- Paracolpi in gomma grigia
- Ruote piroettanti ø cm 12,5

Bianco White



- *AISI 304 stainless steel 2x2 cm square tube construction with bolted cross-members*
- *Chrome-plated steel wire supports suitable for trays having a maximum dimension of 53x39 cm even in different sizes and shapes*
- *White painted electrogalvanized sheet metal*
- *Grey rubber ring buffers*
- *Swivel castors, ø 12.5 cm*

PORTAVASSOI UNIVERSALI CON PANNELLI SU 2 LATI
UNIVERSAL TRAY TROLLEYS WITH PANELS ON 2 SIDES



Art. 1470U-PNB-F

ARTICOLO / ARTICLE	PREZZO / PRICE	PORT. VASSOI / TRAY CAP	SUPPORTO / RUNNERS	PASSO CM / SHELF SPACING	MAX DIM. CM
1470U-PNB	€ 546,00	10 U	In filo Wire		52x60x159 h
1472U-PNB	€ 596,00	12 U			52x60x183 h
1475U-PNB	€ 746,00	20 U			95x60x159 h
1477U-PNB	€ 824,00	24 U			95x60x183 h
1480U-PNB	€ 940,00	30 U			138x60x159 h
1482U-PNB	€ 1.052,00	36 U			138x60x183 h

PORTAVASSOI UNIVERSALI CON PANNELLI SU 3 LATI - RIPIANO SUPERIORE CON RINGHIERINO
UNIVERSAL TRAY TROLLEYS WITH PANELS ON 3 SIDES - TOP SHELF WITH RAILS

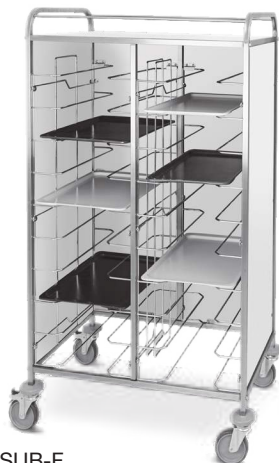

Art. 1476SUB-F

ARTICOLO / ARTICLE	PREZZO / PRICE	PORT. VASSOI / TRAY CAP	SUPPORTO / RUNNERS	PASSO CM / SHELF SPACING	MAX DIM. CM
1471SUB	€ 682,00	10 U	In filo Wire		52x60x159 h
1474SUB	€ 741,00	12 U			52x60x183 h
1476SUB	€ 987,00	20 U			95x60x159 h
1478SUB	€ 1.083,00	24 U			95x60x183 h
1481SUB	€ 1.285,00	30 U			138x60x159 h
1483SUB	€ 1.423,00	36 U			138x60x183 h

OPTIONAL	PREZZO / PRICE	QUANTITÀ	DESCRIZIONE / DESCRIPTION	PER / FOR	IMMAGINE
F	€ 28,00	1	Set 2 ruote con freno Set with 2 braked castors	Tutti gli articoli All Articles	
E	€ 200,00	2	Set 4 ruote elastiche, di cui 2 con freno, per pavimenti sconnessi o per esterno Set with 4 resilient castors, 2 with brake, for uneven floors / outdoor use		
ACCESSORI / ACCESSORIES	PREZZO / PRICE	QUANTITÀ	DESCRIZIONE / DESCRIPTION	PER / FOR	IMMAGINE
A050U	€ 88,00	3	Bacinella estraibile in acciaio inox 1 per ogni colonna Removable stainless steel container 1 for each column	Tutti gli articoli pannellati su 2 lati All articles with panels on 2 sides	

PORTAVASSOI UNIVERSALI - PANNELLI PERSONALIZZATI SU 2 LATI
UNIVERSAL TRAY TROLLEYS - CUSTOMIZED PANELS ON 2 SIDES



- Struttura in tubo quadro di acciaio inox AISI 304 cm 2x2, traversi imbullonati
- Guide in filo di acciaio cromato adatte ad ospitare vassoi con dimensione massima di cm 53x39, anche di forme e dimensioni differenti fra loro
- Pannelli in lamiera elettrozincata verniciata bianca e PVC adesivo coprente, con stampa digitale resistente all'acqua e ai raggi UV, personalizzabile a piacere
- Paracolpi in gomma grigia
- Ruote piroettanti ø cm 12,5

- *AISI 304 stainless steel 2x2 cm square tube construction with bolted cross-members*
- *Chrome-plated steel wire supports suitable for trays having a maximum dimension of 53x39 cm even in different sizes and shapes*
- *White painted electrogalvanized sheet metal covered with adhesive PVC, with water-proof UV-resistant customizable digital print*
- *Grey rubber ring buffers*
- *Swivel castors, ø 12.5 cm*

personalizzabile
customizable

Stampa digitale resistente all'acqua e ai raggi UV, personalizzata a piacere
 NB: file da voi fornito.

Preventivo a richiesta

Customizable water-proof UV-resistant digital print
 Please note: the file containing the image should be provided by you
Quotes upon request



Art. 1470U-ADV-F

ARTICOLO / ARTICLE	PREZZO / PRICE	PORT. VASSOI / TRAY CAP	SUPPORTO / RUNNERS	PASSO CM / SHELF SPACING	MAX DIM. CM
1470U-ADV	€ 795,00	10 U	In filo Wire	11	52x60x159 h
1472U-ADV	€ 866,00	12 U			52x60x183 h
1475U-ADV	€ 993,00	20 U			95x60x159 h
1477U-ADV	€ 1.096,00	24 U			95x60x183 h
1480U-ADV	€ 1.188,00	30 U			138x60x159 h
1482U-ADV	€ 1.324,00	36 U			138x60x183 h

OPTIONAL	PREZZO / PRICE	QUANTITÀ	DESCRIZIONE / DESCRIPTION	PER / FOR	IMMAGINE
F	€ 28,00	1	Set 2 ruote con freno Set with 2 braked castors	Tutti gli articoli All Articles	
E	€ 200,00	2	Set 4 ruote elastiche, di cui 2 con freno, per pavimenti sconnessi o per esterno Set with 4 resilient castors, 2 with brake, for uneven floors / outdoor use		

ACCESSORI / ACCESSORIES	PREZZO / PRICE	QUANTITÀ	DESCRIZIONE / DESCRIPTION	PER / FOR	IMMAGINE
A050U	€ 88,00	3	Bacinella estraibile in acciaio inox 1 per ogni colonna Removable stainless steel container 1 for each column	Tutti gli articoli pannellati su 2 lati All articles with panels on 2 sides	







CARRELLI TERMICI A GIORNO

BAIN-MARIE TROLLEYS

PAG. 52



CARRELLI TERMICI ARMADIATI CON GUIDE STAMPATE

CUPBOARD BAIN-MARIE TROLLEYS WITH PRESSED SHELVES

PAG. 58



CARRELLI TERMICI ARMADIATI CON GUIDE A "C"

CUPBOARD BAIN-MARIE TROLLEYS WITH "C" SHAPED RUNNERS

PAG. 66



BACINELLE GN, COPERCHI E SEPARATORI

GN CONTAINERS, LIDS AND DIVIDERS

PAG. 78

CARRELLI TERMICI A GIORNO BAIN-MARIE TROLLEYS

- Struttura in tubo quadro cm 2x2 e pannelli in lamiera di acciaio inox AISI 304, finitura spazzolata
- Vasca del bagnomaria adatta a contenere bacinelle GN, fino a 20 cm h (escluse)
- Rubinetto per lo scarico dell'acqua del bagnomaria
- Riscaldamento a bagnomaria con resistenza immersa
- Interruttore di accensione con spia luminosa
- Termostato regolabile
- Tensione rete 230 Volt monofase-50/60 Hz
- Cavo spiralato lunghezza 3 mt. spina Schuko per potenze uguali o superiori a 3000W, il cavo viene fornito libero senza spina.
- Parte inferiore a giorno con ripiano asportabile
- Ruote piroettanti ø cm 12,5
- Utilizzabili solo a bagnomaria

- *2x2 cm square steel tube construction with AISI 304 stainless steel sheet panels, brushed finish*
- *Bain-Marie well for up to 20 cm-deep GN pans (not included)*
- *Bain-Marie immersion heating element and drain tap*
- *Bain-Marie drain tap*
- *ON/OFF switch with warning light*
- *Adjustable thermostat*
- *Mains supply: 230V, 50/60 Hz, single-phase*
- *Coiled cable length 3 m. Schuko plug for powers equal to or greater than 3000W, the cable is supplied free without plug.*
- *Open lower part with removable shelf*
- *Swivel castors, ø 12.5 cm*
- *Bain-Marie only*

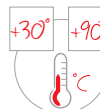

Optional bacinelle vedi pag. 78-79
Optional Gastronorms: see pp. 78-79

Art. 1397-F + Art.A0040

ARTICOLO / ARTICLE	PREZZO / PRICE	GN	POTENZA / POWER	MAX DIM. CM
1395	€ 947,00	1/1	1950W	49x60x84 h
1396	€ 1.085,00	2/1		81x60x84 h
1397	€ 1.203,00	3/1		114x60x84 h
1398	€ 1.415,00	4/1	3400W	153x60x84 h

OPTIONAL	PREZZO / PRICE	📷	DESCRIZIONE / DESCRIPTION	PER / FOR
F	€ 28,00	1	Set 2 ruote con freno Set with 2 braked castors	Tutti gli articoli All Articles
A0040	€ 32,00	-	Maniglia di spinta Pushing handle	



ACCESSORI / ACCESSORIES	PREZZO / PRICE	GRIGLIA FONDO / BOTTOM SAFETY GRILL	PER / FOR
GR1	€ 59,00	1x1/1 GN	1395
GR2	€ 69,00	2x1/1 GN	1396
GR3	€ 80,00	3x1/1 GN	1397
GR4	€ 90,00	4x1/1 GN	1398

CARRELLI TERMICI CON RESISTENZA A SECCO HEATED TROLLEYS WITH DRY HEATING ELEMENTS

- Struttura in acciaio inox AISI 304
- Vasca in doppia parete adatta a contenere bacinelle GN, fino a 15 cm h (escluse)
- Griglia sul fondo
- Riscaldamento con resistenza a secco
- Interruttore accensione con spia luminosa
- Termostato regolabile
- Tensione rete 230 Volt monofase-50/60 Hz
- Cavo spiralato, lunghezza 3 mt. spina Schuko
- Maniglia direzionale
- Ruote piroettanti ø cm 12,5, di cui 2 con freno
- Utilizzabili solo a secco

- *AISI 304 Stainless steel structure*
- *Double skinned well for up to 15 cm-deep GN pans (not included)*
- *Grill on the bottom*
- *Dry heating element*
- *ON/OFF switch with warning light*
- *Adjustable thermostat*
- *Mains supply: 230V, 50/60 Hz, single-phase*
- *3-m long coiled power cable, Schuko plug.*
- Pushing handle
- Swivel castors ø 12.5 cm, 2 with brake
- Dry heating only

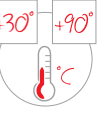

Optional bacinelle vedi pag. 78-79
Optional Gastronorms: see pp. 78-79

Art. 1397RS

ARTICOLO / ARTICLE	PREZZO / PRICE	GN	VASCA / WELL	POTENZA / POWER	MAX DIM. CM
1396RS	€ 956,00	2/1	Unica Single	1000W	88x61x85 h
1397RS	€ 1.082,00	3/1		2x1000W	121x61x85 h
1398RS	€ 1.208,00	4/1			159x61x85 h

CARRELLI TERMICI A GIORNO CON VASCA SUPERIORE UNICA BAIN-MARIE TROLLEYS - SINGLE WELL

- Struttura in tubo quadro cm 2,5x2,5 e pannelli in lamiera di acciaio inox AISI 304, finitura spazzolata
- Coibentazione realizzata con pannelli in poliuretano espanso
- Maniglia di spinta isolata
- Piano inferiore a giorno saldato al telaio
- Vasca bagnomaria unica stampata con bordi arrotondati, adatta a contenere bacinelle GN, fino a cm 20 h (escluse)
- Rubinetto per lo scarico dell'acqua del bagnomaria
- Riscaldamento a umido-bagnomaria, con resistenza esterna alla vasca
- Riscaldamento a secco: caratteristiche e costo a richiesta
- Interruttore di accensione con spia luminosa
- Pannello comandi con termostato regolabile
- Tensione rete 230 Volt monofase-50/60 Hz
- Cavo spiralato, lunghezza 3 mt. spina Schuko
- Paracolpi in gomma angolari
- Ruote piroettanti ø cm 12,5

- 2.5x2.5 cm square steel tube construction with AISI 304 stainless steel sheet panels, brushed finish
- Polyurethane foam insulation panels
- Heat-proof pushing handle
- Lower welded shelf
- Single Bain-Marie well made of pressed steel sheet with no sharp edges for up to 20 cm deep GN pans (not included)
- Bain-Marie drain tap
- Bain-marie heating with heating element outside the well
- Dry heating: details and quotes upon request
- ON/OFF switch with warning light
- Control panel with adjustable thermostat
- Mains supply: 230V, 50/60 Hz, single-phase
- 3-m long coiled power cable, Schuko plug.
- Rubber corner bumpers
- Swivel castors, ø 12.5 cm

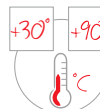

Optional bacinelle vedi pag. 78-79
Optional Gastronorms: see pp. 78-79

Art. 7365-F

ARTICOLO / ARTICLE	PREZZO / PRICE	GN	POTENZA / POWER	MAX DIM. CM
7360	€ 1.734,00	2/1	1200W	87x65x86 h
7365	€ 2.081,00	3/1	1500W	125x65x86 h
7368	€ 2.474,00	4/1	2400W	163x65x86 h

OPTIONAL	PREZZO / PRICE	📷	DESCRIZIONE / DESCRIPTION	PER / FOR
F	€ 28,00	1	Set 2 ruote con freno Set with 2 braked castors	Tutti gli articoli All Articles



1

COPERCHIO

LID

Coperchi superiori isolati termicamente, aperti possono servire da piano d'appoggio
Struttura in lamiera di acciaio inox AISI 304, finitura spazzolata

*Insulated lids, when open they can be used as support
AISI 304 stainless steel sheet construction, brushed finish*

OPTIONAL	PREZZO / PRICE	DESCRIZIONE / DESCRIPTION	TIPOLOGIA / TYPOLOGY	PER / FOR
C2	€ 760,00	Coperchi superiori Top lids	apribili a 180° opening to 180°	2x1/1 GN
C3	€ 803,00			3x1/1 GN



PARAFIATO

SNEEZE GUARD

OPTIONAL	PREZZO / PRICE	📷	DESCRIZIONE / DESCRIPTION	TIPOLOGIA / TYPOLOGY	PER / FOR
PAR2L	€ 580,00	2	Parafiato in vetro Glass sneeze guard	Standard Standard	2x1/1 GN
PAR2H	€ 651,00	3		Apertura "servi-piatti bambini" "Kid-service" opening	
PAR3L	€ 609,00	2		Standard Standard	3x1/1 GN
PAR3H	€ 686,00	3		Apertura "servi-piatti bambini" "Kid-service" opening	
PAR4L	€ 687,00	2		Standard Standard	4x1/1 GN
PAR4H	€ 703,00	3		Apertura "servi-piatti bambini" "Kid-service" opening	



MENSOLA SCORRIVASSOI

TRAY SLIDE SHELF

OPTIONAL	PREZZO / PRICE	DESCRIZIONE / DESCRIPTION	PER / FOR
ME2	€ 175,00	Mensola scorrevassoio lato lungo Tray slide shelf, long side	2x1/1 GN
ME3	€ 192,00		3x1/1 GN
ME4	€ 246,00		4x1/1 GN



CARRELLI TERMICI A GIORNO CON TEMPERATURE DIFFERENZIATE BAIN-MARIE TROLLEYS WITH SEPARATE WELLS

- Struttura in tubo quadro cm 2,5x2,5 e pannelli in lamiera di acciaio inox AISI 304, finitura spazzolata
- Coibentazione realizzata con pannelli in poliuretano espanso
- Maniglia di spinta isolata
- Piano inferiore a giorno saldato al telaio
- Vasca bagnomaria, a temperature indipendenti, stampata con bordi arrotondati, adatta a contenere bacinelle GN, fino a cm 20 h (escluse)
- Rubinetto per lo scarico dell'acqua del bagnomaria
- Riscaldamento a umido-bagnomaria che a secco (resistenza esterna alla vasca)
- Interruttore di accensione con spia luminosa
- Pannello comandi con termostato regolabile
- Tensione rete 230 Volt monofase-50/60 Hz
- Cavo spiralato lunghezza 3mt., spina Schuko
- Paracolpi in gomma angolari
- Ruote piroettanti ø cm 12,5

- 2.5x2.5 cm square steel tube construction with AISI 304 stainless steel sheet panels, brushed finish
- Polyurethane foam insulation panels
- Heat-proof pushing handle
- Open lower shelf welded to the frame
- Bain-Marie wells with separate temperature control in pressed steel sheet with no sharp edges for up to 20 cm-deep GN pans (not included)
- Tap for draining the bain-marie water
- Bain-marie wet and dry heating (resistance external to the tank)
- ON/OFF switch with warning light
- Control panel with adjustable thermostat
- Mains supply: 230V, 50/60 Hz, single-phase
- 3m long coiled cable, Schuko plug
- Rubber corner bumpers
- Swivel castors, ø 12.5 cm

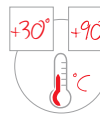

Optional bacinelle vedi pag. 78-79
Optional Gastronorms: see pp. 78-79

Art. 7375-F

ARTICOLO / ARTICLE	PREZZO / PRICE	GN	POTENZA / POWER	MAX DIM. CM
7370	€ 1.770,00	2x1/1	1200W	87x65x86 h
7375	€ 2.538,00	3x1/1	1800W	125x65x86 h
7378	€ 3.032,00	4x1/1	2400W	163x65x86 h

OPTIONAL	PREZZO / PRICE	IMMAGINE	DESCRIZIONE / DESCRIPTION	PER / FOR
F	€ 28,00	1	Set 2 ruote con freno Set with 2 braked castors	Tutti gli articoli All Articles



1

COPERCHIO

LID

Coperchi superiori isolati termicamente, aperti possono servire da piano d'appoggio
Struttura in lamiera di acciaio inox AISI 304, finitura spazzolata

*Insulated lids, when open they can be used as support
AISI 304 stainless steel sheet construction, brushed finish*

OPTIONAL	PREZZO / PRICE	DESCRIZIONE / DESCRIPTION	TIPOLOGIA / TYPOLOGY	PER / FOR
C2	€ 760,00	Coperchi superiori Top lids	apribili a 180° opening to 180°	2x1/1 GN
C3	€ 803,00			3x1/1 GN



PARAFIATO

SNEEZE GUARD

OPTIONAL	PREZZO / PRICE		DESCRIZIONE / DESCRIPTION	TIPOLOGIA / TYPOLOGY	PER / FOR
PAR2L	€ 580,00	2	Parafiato in vetro Glass sneeze guard	Standard Standard	2x1/1 GN
PAR2H	€ 651,00	3		Apertura "servi-piatti bambini" "Kid-service" opening	
PAR3L	€ 609,00	2		Standard Standard	3x1/1 GN
PAR3H	€ 686,00	3		Apertura "servi-piatti bambini" "Kid-service" opening	
PAR4L	€ 687,00	2		Standard Standard	4x1/1 GN
PAR4H	€ 703,00	3		Apertura "servi-piatti bambini" "Kid-service" opening	



2



3

MENSOLA SCORRIVASSOI

TRAY SLIDE SHELF

OPTIONAL	PREZZO / PRICE	DESCRIZIONE / DESCRIPTION	PER / FOR
ME2	€ 175,00	Mensola scorrevassoio lato lungo Tray slide shelf, long side	2x1/1 GN
ME3	€ 192,00		3x1/1 GN
ME4	€ 246,00		4x1/1 GN



PRESENTAZIONE CARRELLI TERMICI ARMADIATI CUPBOARD BAIN-MARIE TROLLEYS OVERVIEW

- Acciaio inox AISI 304, finitura spazzolata
 - Coibentazione realizzata con pannelli in poliuretano espanso
 - Maniglie di spinta isolate
 - Vasche bagnomaria uniche o separate, adatte a contenere bacinelle GN
 - Rubinetto unico o multiplo per lo scarico dell'acqua del bagnomaria
 - Vani inferiori unici o separati, neutri, riscaldati, refrigerati o misti
 - Tensione rete 230 Volt monofase-50/60 Hz
 - Riscaldamento a umido-bagnomaria, con resistenza esterna alla vasca
 - Riscaldamento a secco: caratteristiche e costo a richiesta
 - Pannello comandi con termostati regolabili indipendenti, uno per ogni elemento riscaldato (da +30°C a +90°C) o refrigerato (da +4°C a +10°C).
 - Cavo di alimentazione spiralato, lung. 3 mt, spina Schuko.
 - Paracolpi perimetrali in gomma grigia antitraccia
 - Ruote Ø cm 16, 2 fisse, 2 piroettanti con freno
- AISI 304 stainless steel, brushed finish
 - Polyurethane foam insulation panels
 - Heat-proof pushing handles
 - Single or separate Bain-Marie wells, suitable for GN pans
 - One or more Bain-Marie drain taps
 - Single or separate neutral, heated, refrigerated or mixed lower compartments
 - Mains supply: 230V, 50/60 Hz, single-phase
 - Bain-marie heating with heating element outside the well
 - Dry heating: details and quotes upon request
 - Control panel with independent thermostatic control, one for each heated (+30°C to +90°C) or refrigerated (+4°C to +10°C) compartment.
 - 3-mt long coiled power cable, Schuko plug
 - All round grey non marking rubber bumpers
 - Castors Ø 16 cm, 2 fixed, 2 swivel with brake

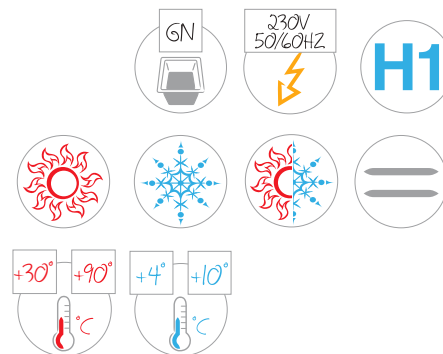

OPTIONAL

COPERCHI PER ARTICOLI 2 GN - 3 GN



(C2-C3)
Coperchi apribili a 180°
Lids opening to 180°

LIDS FOR 2 GN - 3 GN ITEMS



(L2-L3)
Coperchi apribili a 2/3 + 1/3
Lids opening 2/3 + 1/3 on the long side

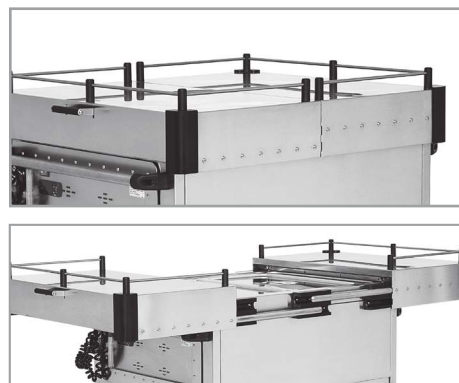

(S2-S3)
Coperchi scorrevoli
Sliding lids on the long side



PARAFIATO IN ACCIAIO E VETRO
(non montabile sul carrello con i coperchi)
Art. PAR2L - PAR3L - PAR4L
STEEL AND GLASS SNEEZE GUARD
(it cannot be mounted on trolleys with lids)
Art. PAR2L - PAR3L - PAR4L



PARAFIATO IN ACCIAIO E VETRO CON "APERTURA SERVI PIATTI BAMBINI"
(non montabile sul carrello con i coperchi)
Art. PAR2H - PAR3H - PAR4H
STEEL AND GLASS SNEEZE GUARD WITH "KID-SERVICE" OPENING
(it cannot be mounted on trolleys with lids)
Art. PAR2H - PAR3H - PAR4H



MENSOLA IN TUBO INOX
frontale, ribaltabile
TRAY SLIDE SHELF
frontal, drop-down



PANNELLO DIGITALE ISOLATO IPX5
IPX5 INSULATED DIGITAL PANEL



TIMONE CON GANCIO
per traino
TOW BAR
with coupler



SET 4 RUOTE ELASTICHE
di cui 2 con freno, per pavimenti sconnessi o per esterni.
SET OF 4 RESILIENT WHEELS
2 with brake for uneven floors / outdoor use

VANI INFERIORI SEPARATI CON GUIDE A "C"
SEPARATE LOWER COMPARTMENTS WITH "C"-SHAPED RUNNERS

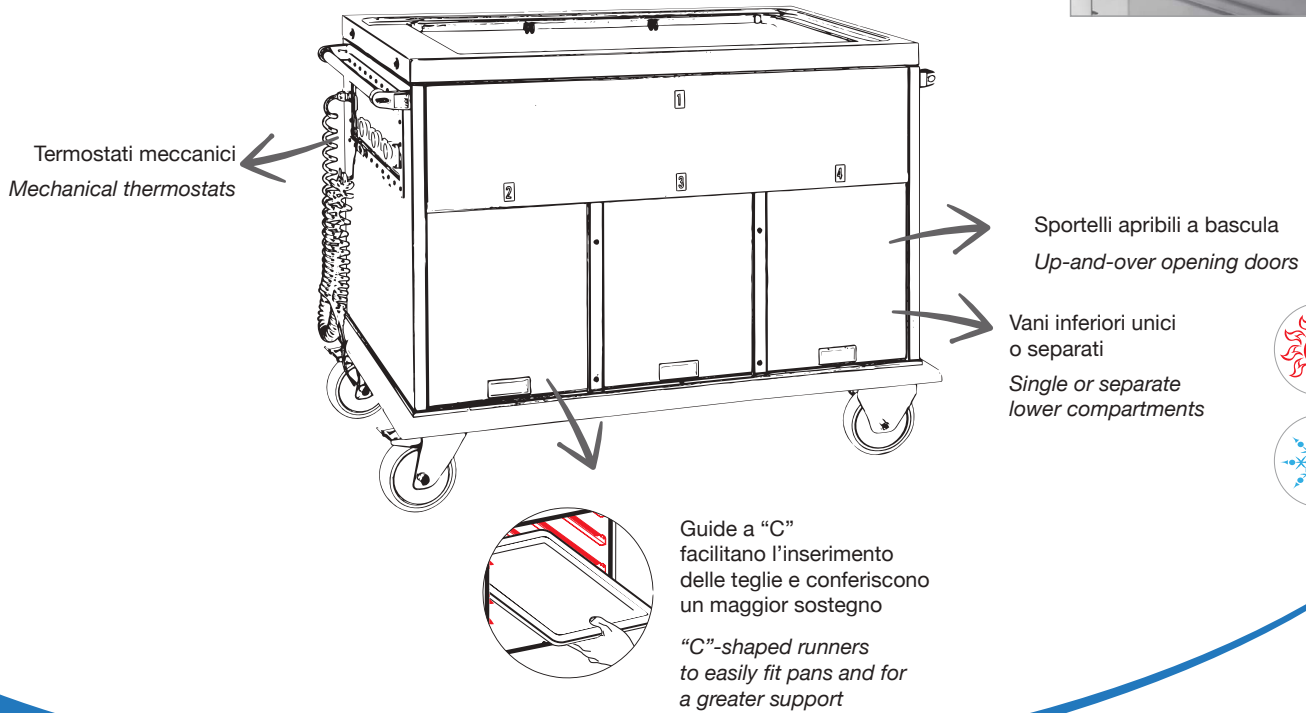

VANI INFERIORI SEPARATI IN "H1" CON GUIDE STAMPATE
SEPARATE LOWER COMPARTMENTS COMPLIANT WITH "H1" SYSTEM WITH PRESSED RUNNERS

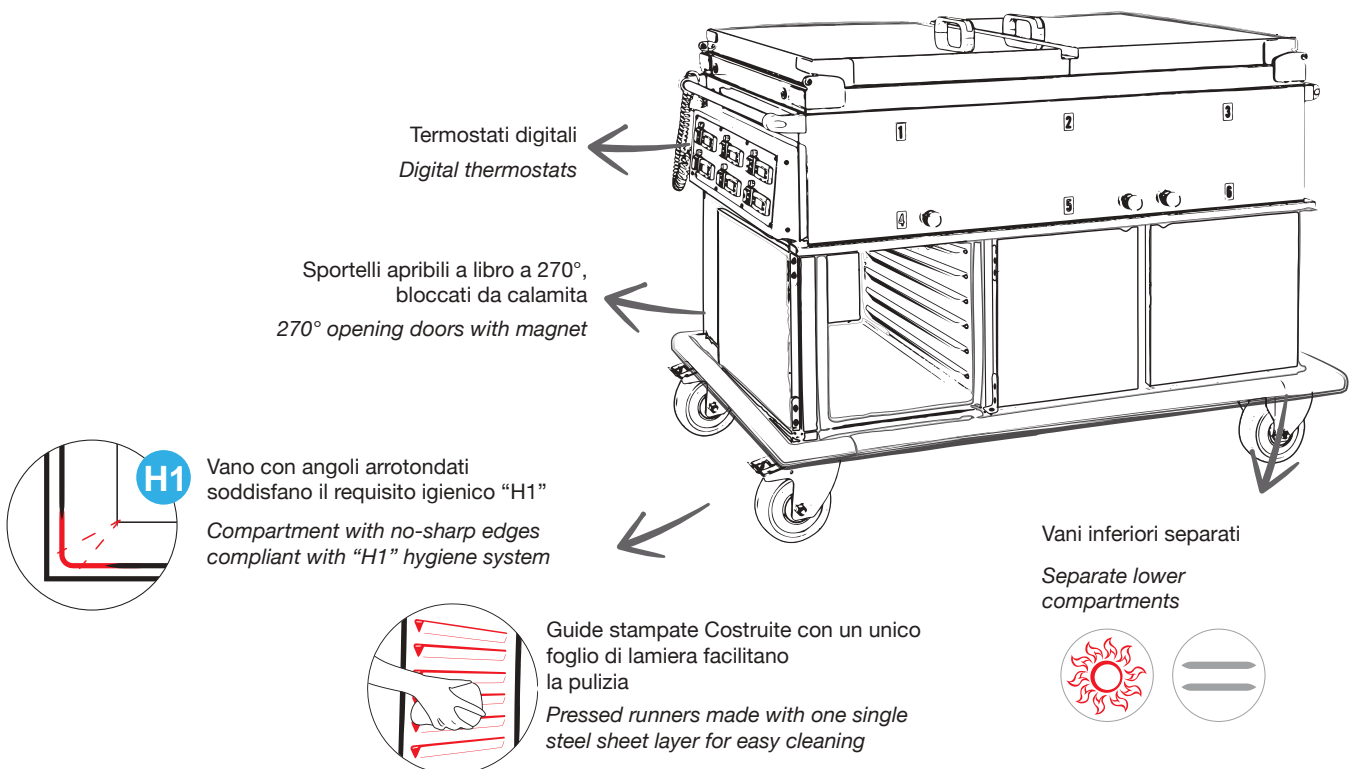

CARRELLI TERMICI ARMADIATI VASCA UNICA - GUIDE STAMPATE BAIN-MARIE CUPBOARD TROLLEYS SINGLE WELL - PRESSED SHELVES

- Struttura in lamiera di acciaio inox AISI 304, finitura spazzolata
- Coibentazione realizzata con pannelli in poliuretano espanso
- Maniglie di spinta isolate
- Vasca bagnomaria unica stampata con bordi arrotondati, adatta a contenere bacinelle GN, fino a cm 20 h (escluse)
- Rubinetto per lo scarico dell'acqua del bagnomaria
- Vani inferiori con angoli arrotondati (soddisfano il requisito igienico H1) separati, riscaldati o neutri, termostattizzati indipendenti con sportelli coibentati apribili a libro, magneti di bloccaggio a porta aperta. N. 6 coppie di guide "stampate" adatte ad ospitare bacinelle 1/1 GN o sottomultipli con una distanza di 5,5 cm
- Tensione rete 230 Volt monofase-50/60 Hz
- Riscaldamento a umido-bagnomaria, con resistenza esterna alla vasca
- Riscaldamento a secco: caratteristiche e costo a richiesta
- Pannello comandi digitale IPX5 di serie, con termostati indipendenti regolabili, uno per ogni elemento riscaldato
- Cavo spiralato, lunghezza 3 mt., spina Schuko. Per potenze uguali o superiori a 3000W, il cavo viene fornito libero senza spina.
- Paracolpi perimetrali in gomma grigia antitraccia
- Ruote ø cm 16, 2 fisse, 2 piroettanti con freno, supporto zincato, anello in gomma grigia antitraccia, rotolamento su cuscinetti

- AISI 304 stainless steel sheet construction, brushed finish
- Polyurethane foam insulation panels
- Heat-proof pushing handles
- Single Bain-Marie well in pressed steel sheet with no sharp edges for up to 20 cm-deep GN pans (not included)
- Bain-Marie drain tap
- Separate heated or neutral lower compartments with no-sharp edges (compliant with H1 hygiene system), with independent thermostats, insulated 270° opening side doors, with magnet (to keep the doors open). N. 6 pairs of "pressed" runners suitable for containers 1/1 GN (or submultiples) spaced 5.5 cm
- Mains supply: 230V, 50/60 Hz, single-phase
- Bain-Marie heating with heating element outside the well
- Dry heating: details and quotes upon request
- IPX5 digital control panel supplied as standard with independent thermostatic control - one thermostat for each heated well/compartment
- 3m long coiled cable, Schuko plug. For powers equal to or greater than 3000W, the cable is supplied free without plug. For the plug, see optional item T200
- All round grey non marking rubber bumpers
- 2 Fixed and 2 braked swivel castors with heavy-duty brackets, ø 16 cm; grey non marking rubber tread on centre with roller bearing hub

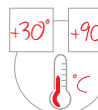

Art. 7365A3-GS-E

Optional + accessori vedi pag. 76-77
Optional + accessories: see pp. 76-77

Optional bacinelle vedi pag. 78-79
Optional Gastronorms: see pp. 78-79



H1



N.B.: il pannello digitale IPX5 è di serie nei carrelli termici armati con guide stampate (serie "GS").

Note: IPX5 digital control panel is supplied as standard in the Bain-Marie trolleys with pressed runners ("GS" range)

☐ = neutro
☐ = neutral
☀ = caldo
☀ = hot

ARTICOLO / ARTICLE	PREZZO / PRICE	GN	VANO INF / LOWER COMP	POTENZA / POWER	MAX DIM. CM
7360A0-GS	€ 3.796,00	2/1	☐ ☐	1200W	95x72x96 h
7360A1-GS	€ 3.947,00		☐ ☀	1700W	
7360A2-GS	€ 4.099,00		☀ ☀	2200W	
7365A0-GS	€ 4.733,00	3/1	☐ ☐ ☐	1500W	134x72x96 h
7365A1-GS	€ 4.961,00		☐ ☐ ☀	2000W	
7365A2-GS	€ 5.103,00		☐ ☀ ☀	2500W	
7365A3-GS	€ 5.248,00		☀ ☀ ☀	3000W	

OPTIONAL	PREZZO / PRICE	📷	DESCRIZIONE / DESCRIPTION	PER / FOR
E	€ 97,00	1	Set 4 ruote elastiche, di cui 2 con freno, per pavimenti sconnessi o per esterni Set of 4 resilient wheels, 2 with brake for uneven floors / outdoor use	Tutti gli articoli All Articles

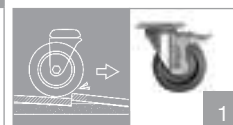

COPERCHIO

LID

Coperchi superiori isolati termicamente, aperti possono servire da piano d'appoggio
Struttura in lamiera di acciaio inox AISI 304, finitura spazzolata

*Insulated lids, when open they can be used as support
AISI 304 stainless steel sheet construction, brushed finish*

OPTIONAL	PREZZO / PRICE	DESCRIZIONE / DESCRIPTION	TIPOLOGIA / TYPOLOGY	PER / FOR
C2	€ 760,00	Coperchi superiori Top lids	apribili a 180° opening to 180°	2x1/1 GN
C3	€ 803,00			3x1/1 GN
L2	€ 793,00		apribili a 2/3 + 1/3: apertura con supporto a 180° oppure fino a 270° senza supporto	2x1/1 GN
L3	€ 884,00		opening to 2/3 + 1/3: opening up to 180° with supports or up to 270° without supports	3x1/1 GN
S2	€ 2.121,00		scorrevoli sliding	2x1/1 GN
S3	€ 2.350,00			3x1/1 GN



PARAFIATO

SNEEZE GUARD

OPTIONAL	PREZZO / PRICE	📷	DESCRIZIONE / DESCRIPTION	TIPOLOGIA / TYPOLOGY	PER / FOR
PAR2L	€ 580,00	2	Parafiato in vetro Glass sneeze guard	Standard Standard	2x1/1 GN
PAR2H	€ 651,00	3		Apertura "servi-piatti bambini" "Kid-service" opening	
PAR3L	€ 609,00	2		Standard Standard	3x1/1 GN
PAR3H	€ 686,00	3		Apertura "servi-piatti bambini" "Kid-service" opening	



MENSOLA SCORRIVASSOI

TRAY SLIDE SHELF

OPTIONAL	PREZZO / PRICE	DESCRIZIONE / DESCRIPTION	PER / FOR
ME2	€ 175,00	Mensola scorrevassoio lato lungo Tray slide shelf, long side	2x1/1 GN
ME3	€ 192,00		3x1/1 GN



CARRELLI TERMICI ARMADIATI - VASCA CON TEMPERATURE DIFFERENZIATE - GUIDE STAMPATE
BAIN-MARIE CUPBOARD TROLLEYS - SEPARATE WELLS LOWER COMPARTMENTS WITH PRESSED RUNNERS

- Struttura in lamiera di acciaio inox AISI 304, finitura spazzolata
- Coibentazione realizzata con pannelli in poliuretano espanso
- Maniglie di spinta isolate
- Vasche bagnomaria separate stampate con bordi arrotondati, adatte a contenere bacinelle GN, fino a cm 20 h (escluse)
- Rubinetto multiplo per lo scarico dell'acqua del bagnomaria
- Vani inferiori con angoli arrotondati (soddisfano il requisito igienico H1) separati, riscaldati o neutri, termostattizzati indipendenti con sportelli coibentati apribili a libro, magneti di bloccaggio a porta aperta. N. 6 coppie di guide "stampate" adatte ad ospitare bacinelle 1/1 GN o sottomultipli con una distanza di 5,5 cm
- Tensione rete 230 Volt monofase-50/60 Hz
- Riscaldamento sia ad umido-bagnomaria che a secco (resistenza esterna alla vasca)
- Pannello comandi digitale IPX5 di serie, con termostati indipendenti regolabili, uno per ogni elemento riscaldato
- Cavo spiralatolunghezza 3 mt. spina Schuko. Per potenze uguali o superiori a 3000W, il cavo viene fornito libero senza spina
- Paracolpi perimetrali in gomma grigia antitraccia
- Ruote ø cm 16, 2 fisse, 2 piroettanti con freno, supporto zincato, anello in gomma grigia antitraccia, rotolamento su cuscinetti

- AISI 304 stainless steel sheet construction, brushed finish
- Polyurethane foam insulation panels
- Heat-proof pushing handles
- Separate Bain-Marie wells in pressed steel sheet with no sharp edges for up to 20 cm deep GN pans (not included)
- Separate Bain-Marie drain taps
- Separate heated or neutral lower compartments with no-sharp edges (compliant with H1 hygiene system), with independent thermostats, insulated 270° opening side doors, with magnet (to keep the doors open). N. 6 pairs of "pressed" runners suitable for containers 1/1 GN (or submultiples) spaced 5.5 cm
- Mains supply: 230V, 50/60 Hz, single-phase
- Heating both wet-bain-marie and dry (external resistance to the tank)
- IPX5 digital control panel supplied as standard with independent thermostatic control - one thermostat for each heated well/ compartment.
- 3m long coiled cable, Schuko plug. For powers equal to or greater than 3000W, the cable is supplied free without plug. For the plug, see optional item T200.
- All round grey non marking rubber bumpers
- 2 Fixed and 2 braked swivel castors with heavy-duty brackets, ø 16 cm; grey non marking rubber tread on centre with roller bearing hub

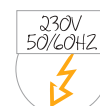
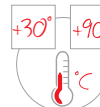

Optional + accessori vedi pag. 76-77
 Optional + accessories: see pp. 76-77

Optional bacinelle vedi pag. 78-79
 Optional Gastronorms: see pp. 78-79

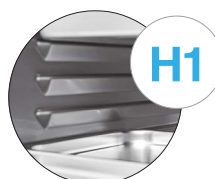

Art. 7375A3-GS-E-C3

N.B.: il pannello digitale IPX5 è di serie nei carrelli termici armati con guide stampate (serie "GS").

Note: IPX5 digital control panel is supplied as standard in the Bain-Marie trolleys with pressed runners ("GS" range)

☰ = neutro
 = neutral
 ☀ = caldo
 = hot

ARTICOLO / ARTICLE	PREZZO / PRICE	GN	VANO INF / LOWER COMP	POTENZA / POWER	MAX DIM. CM
7370A0-GS	€ 4.121,00	2/1	☰ ☰	1000W	95x72x96 h
7370A1-GS	€ 4.271,00		☰ ☀	1500W	
7370A2-GS	€ 4.423,00		☀ ☀	2000W	
7375A0-GS	€ 5.414,00	3/1	☰ ☰ ☰	1500W	134x72x96 h
7375A1-GS	€ 5.651,00		☰ ☰ ☀	2000W	
7375A2-GS	€ 5.802,00		☰ ☀ ☀	2500W	
7375A3-GS	€ 5.953,00		☀ ☀ ☀	3000W	

OPTIONAL	PREZZO / PRICE	📷	DESCRIZIONE / DESCRIPTION	PER / FOR
E	€ 97,00	1	Set 4 ruote elastiche, di cui 2 con freno, per pavimenti sconnessi o per esterni Set of 4 resilient wheels, 2 with brake for uneven floors / outdoor use	Tutti gli articoli All Articles

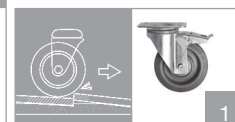

COPERCHIO

LID

Coperchi superiori isolati termicamente, aperti possono servire da piano d'appoggio
Struttura in lamiera di acciaio inox AISI 304, finitura spazzolata

*Insulated lids, when open they can be used as support
AISI 304 stainless steel sheet construction, brushed finish*

OPTIONAL	PREZZO / PRICE	DESCRIZIONE / DESCRIPTION	TIPOLOGIA / TYPOLOGY	PER / FOR
C2	€ 760,00	Coperchi superiori Top lids	apribili a 180° opening to 180°	2x1/1 GN
C3	€ 803,00			3x1/1 GN
L2	€ 793,00		apribili a 2/3 + 1/3: apertura con supporto a 180° oppure fino a 270° senza supporto	2x1/1 GN
L3	€ 884,00		opening to 2/3 + 1/3: opening up to 180° with supports or up to 270° without supports	3x1/1 GN
S2	€ 2.121,00		scorrevoli sliding	2x1/1 GN
S3	€ 2.350,00			3x1/1 GN



PARAFIATO

SNEEZE GUARD

OPTIONAL	PREZZO / PRICE		DESCRIZIONE / DESCRIPTION	TIPOLOGIA / TYPOLOGY	PER / FOR
PAR2L	€ 580,00	2	Parafiato in vetro Glass sneeze guard	Standard Standard	2x1/1 GN
PAR2H	€ 651,00	3		Apertura "servi-piatti bambini" "Kid-service" opening	
PAR3L	€ 609,00	2		Standard Standard	3x1/1 GN
PAR3H	€ 686,00	3		Apertura "servi-piatti bambini" "Kid-service" opening	



MENSOLA SCORRIVASSOI

TRAY SLIDE SHELF

OPTIONAL	PREZZO / PRICE	DESCRIZIONE / DESCRIPTION	PER / FOR
ME2	€ 175,00	Mensola scorrevassoio lato lungo Tray slide shelf, long side	2x1/1 GN
ME3	€ 192,00		3x1/1 GN



CARRELLI TERMICI ARMADIATI - VASCA UNICA

BAIN-MARIE CUPBOARD TROLLEYS - SINGLE WELL SINGLE NEUTRAL LOWER COMPARTMENT

- Struttura in lamiera di acciaio inox AISI 304, finitura spazzolata
- Coibentazione realizzata con pannelli in poliuretano espanso
- Maniglie di spinta isolate
- Vasca bagnomaria unica stampata con bordi arrotondati, adatta a contenere bacinelle GN, fino a cm 20 h (escluse)
- Rubinetto per lo scarico dell'acqua del bagnomaria
- Vano inferiore unico, neutro, con sportello apribile a bascula
- Tensione rete 230 Volt monofase-50/60 Hz
- Riscaldamento a umido-bagnomaria, con resistenza esterna alla vasca
- Riscaldamento a secco: caratteristiche e costo a richiesta
- Pannello comandi con termostato meccanico regolabile
- Cavo di alimentazione spiralato, lunghezza 3 metri, spina Schuko
- Paracolpi perimetrali in gomma grigia antitraccia
- Ruote ø cm 16, 2 fisse, 2 piroettanti con freno, supporto zincato, anello in gomma grigia antitraccia, rotolamento su cuscinetti

- AISI 304 stainless steel sheet construction, brushed finish
- Polyurethane foam insulation panels
- Heat-proof pushing handles
- Single Bain-Marie well in pressed steel sheet with no sharp edges for up to 20 cm-deep GN pans (not included)
- Bain-Marie drain tap
- Single lower neutral compartment with up-and-over door
- Mains supply: 230V, 50/60 Hz, single-phase
- Bain-marie heating with heating element outside the well
- Dry heating: details and quotes upon request
- Control panel with mechanical thermostatic control
- 3-mt long coiled power cable, Schuko plug
- All round grey non marking rubber bumpers
- 2 Fixed and 2 braked swivel castors with heavy-duty brackets, ø 16 cm; grey non marking rubber tread on centre with roller bearing hub

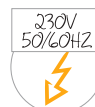
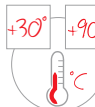

Optional + accessori vedi pag. 76-77
Optional + accessories: see pp. 76-77

Optional bacinelle vedi pag. 78-79
Optional Gastronorms: see pp. 78-79

Art. 7365A

☐ = neutro
☐ = neutral

ARTICOLO / ARTICLE	PREZZO / PRICE	GN	VANO INF / LOWER COMP	POTENZA / POWER	MAX DIM. CM
7360A	€ 2.610,00	2/1	☐	1200W	95x72x96 h
7365A	€ 3.045,00	3/1		1500W	134x72x96 h
7368A	€ 3.561,00	4/1		2400W	172x72x96 h

OPTIONAL	PREZZO / PRICE	📷	DESCRIZIONE / DESCRIPTION	PER / FOR
E	€ 97,00	1	Set 4 ruote elastiche, di cui 2 con freno, per pavimenti sconnessi o per esterni Set of 4 resilient wheels, 2 with brake for uneven floors / outdoor use	Tutti gli articoli All Articles

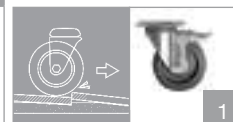

COPERCHIO

LID

Coperchi superiori isolati termicamente, aperti possono servire da piano d'appoggio
Struttura in lamiera di acciaio inox AISI 304, finitura spazzolata

*Insulated lids, when open they can be used as support
AISI 304 stainless steel sheet construction, brushed finish*

OPTIONAL	PREZZO / PRICE	DESCRIZIONE / DESCRIPTION	TIPOLOGIA / TYPOLOGY	PER / FOR
C2	€ 760,00	Coperchi superiori Top lids	apribili a 180° opening to 180°	2x1/1 GN
C3	€ 803,00			3x1/1 GN
L2	€ 793,00		apribili a 2/3 + 1/3: apertura con supporto a 180° oppure fino a 270° senza supporto	2x1/1 GN
L3	€ 884,00		opening to 2/3 + 1/3: opening up to 180° with supports or up to 270° without supports	3x1/1 GN
S2	€ 2.121,00		scorrevoli sliding	2x1/1 GN
S3	€ 2.350,00			3x1/1 GN



PARAFIATO

SNEEZE GUARD

OPTIONAL	PREZZO / PRICE		DESCRIZIONE / DESCRIPTION	TIPOLOGIA / TYPOLOGY	PER / FOR
PAR2L	€ 580,00	2	Parafiato in vetro Glass sneeze guard	Standard / Standard	2x1/1 GN
PAR2H	€ 651,00	3		Apertura "servi-piatti bambini" "Kid-service" opening	
PAR3L	€ 609,00	2		Standard / Standard	3x1/1 GN
PAR3H	€ 686,00	3		Apertura "servi-piatti bambini" "Kid-service" opening	
PAR4L	€ 687,00	2		Standard / Standard	4x1/1 GN
PAR4H	€ 703,00	3		Apertura "servi-piatti bambini" "Kid-service" opening	



MENSOLA SCORRIVASSOI

TRAY SLIDE SHELF

OPTIONAL	PREZZO / PRICE	DESCRIZIONE / DESCRIPTION	PER / FOR
ME2	€ 175,00	Mensola scorrevassoio lato lungo Tray slide shelf, long side	2x1/1 GN
ME3	€ 192,00		3x1/1 GN
ME4	€ 246,00		4x1/1 GN



CARRELLI TERMICI ARMADIATI - VASCA UNICA

BAIN-MARIE CUPBOARD TROLLEYS - SINGLE WELL SEPARATE NEUTRAL AND HEATED LOWER COMPARTMENTS WITH "C"- SHAPED RUNNERS

- Struttura in lamiera di acciaio inox AISI 304, finitura spazzolata
- Coibentazione realizzata con pannelli in poliuretano espanso
- Maniglie di spinta isolate
- Vasca bagnomaria unica stampata con bordi arrotondati, adatta a contenere bacinelle GN, fino a cm 20 h (escluse)
- Rubinetto per lo scarico dell'acqua del bagnomaria
- Vani inferiori, separati, riscaldati o neutri, termostattizzati indipendenti con sportelli coibentati apribili a bascula. N. 4 coppie di guide a "C" adatte ad ospitare bacinelle 1/1 GN o sottomultipli con una distanza di 7,6 cm
- Tensione rete 230 Volt monofase-50/60 Hz
- Riscaldamento a umido-bagnomaria, con resistenza esterna alla vasca
- Riscaldamento a secco: caratteristiche e costo a richiesta
- Pannello comandi con termostati meccanici indipendenti regolabili, uno per ogni elemento riscaldato
- Cavo spiralato lunghezza 3 mt. spina Schuko. Per potenze uguali o superiori a 3000W, il cavo viene fornito libero senza spina
- Paracolpi perimetrali in gomma grigia antitraccia
- Ruote ø cm 16, 2 fisse, 2 piroettanti con freno, supporto zincato, anello in gomma grigia antitraccia, rotolamento su cuscinetti

- AISI 304 stainless steel sheet construction, brushed finish
- Polyurethane foam insulation panels
- Heat-proof pushing handles
- Single Bain-Marie well in pressed steel sheet with no sharp edges for up to 20 cm-deep GN pans (not included)
- Bain-Marie drain tap
- Separate heated or neutral lower compartments with independent thermostats, insulated up-and-over doors. N. 4 pairs of "C"-shaped runners suitable for containers 1/1 GN (or submultiples) spaced 7.6 cm
- Mains supply: 230V, 50/60 Hz, single-phase
- Bain-marie heating with heating element outside the well
- Dry heating: details and quotes upon request
- Control panel with independent mechanical thermostatic control - one thermostat for each heated well/compartment
- 3m long coiled cable, Schuko plug. For powers equal to or greater than 3000W, the cable is supplied free without plug. For the plug, see optional item T200.
- All round grey non marking rubber bumpers
- 2 Fixed and 2 braked swivel castors with heavy-duty brackets, ø 16 cm; grey non marking rubber tread on centre with roller bearing hub

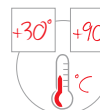

Optional + accessori vedi pag. 76-77
Optional + accessories: see pp. 76-77

Optional bacinelle vedi pag. 78-79
Optional Gastronorms: see pp. 78-79

☐ = neutro
☐ = neutral
☀ = caldo
☀ = hot

ARTICOLO / ARTICLE	PREZZO / PRICE	GN	VANO INF / LOWER COMP	POTENZA / POWER	MAX DIM. CM
7360A0	€ 3.282,00	2/1	☐ ☐	1200W	95x72x96 h
7360A1	€ 3.412,00		☐ ☀	1800W	
7360A2	€ 3.543,00		☀ ☀	2400W	
7365A0	€ 4.091,00	3/1	☐ ☐ ☐	1500W	134x72x96 h
7365A1	€ 4.288,00		☐ ☐ ☀	2400W	
7365A2	€ 4.414,00		☐ ☀ ☀	2700W	
7365A3	€ 4.538,00		☀ ☀ ☀	3300W	
7368A0	€ 5.067,00	4/1	☐ ☐ ☐ ☐	2400W	172x72x96 h
7368A1	€ 5.197,00		☐ ☐ ☐ ☀	3000W	
7368A2	€ 5.327,00		☐ ☐ ☀ ☀	3600W	
7368A3	€ 5.459,00		☐ ☀ ☀ ☀	4200W	
7368A4	€ 5.590,00		☀ ☀ ☀ ☀	4800W	

OPTIONAL	PREZZO / PRICE	📷	DESCRIZIONE / DESCRIPTION	PER / FOR
E	€ 97,00	1	Set 4 ruote elastiche, di cui 2 con freno, per pavimenti sconnessi o per esterni Set of 4 resilient wheels, 2 with brake for uneven floors / outdoor use	Tutti gli articoli All Articles

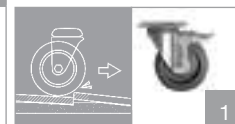

COPERCHIO

LID

Coperchi superiori isolati termicamente, aperti possono servire da piano d'appoggio
Struttura in lamiera di acciaio inox AISI 304, finitura spazzolata

*Insulated lids, when open they can be used as support
AISI 304 stainless steel sheet construction, brushed finish*

OPTIONAL	PREZZO / PRICE	DESCRIZIONE / DESCRIPTION	TIPOLOGIA / TYPOLOGY	PER / FOR
C2	€ 760,00	Coperchi superiori Top lids	apribili a 180° opening to 180°	2x1/1 GN
C3	€ 803,00			3x1/1 GN
L2	€ 793,00		apribili a 2/3 + 1/3: apertura con supporto a 180° oppure fino a 270° senza supporto	2x1/1 GN
L3	€ 884,00		opening to 2/3 + 1/3: opening up to 180° with supports or up to 270° without supports	3x1/1 GN
S2	€ 2.121,00		scorrevoli sliding	2x1/1 GN
S3	€ 2.350,00			3x1/1 GN



PARAFIATO

SNEEZE GUARD

OPTIONAL	PREZZO / PRICE		DESCRIZIONE / DESCRIPTION	TIPOLOGIA / TYPOLOGY	PER / FOR
PAR2L	€ 580,00	2	Parafiato in vetro Glass sneeze guard	Standard / Standard	2x1/1 GN
PAR2H	€ 651,00	3		Apertura "servi-piatti bambini" "Kid-service" opening	
PAR3L	€ 609,00	2		Standard / Standard	3x1/1 GN
PAR3H	€ 686,00	3		Apertura "servi-piatti bambini" "Kid-service" opening	
PAR4L	€ 687,00	2		Standard / Standard	4x1/1 GN
PAR4H	€ 703,00	3		Apertura "servi-piatti bambini" "Kid-service" opening	



MENSOLA SCORRIVASSOI

TRAY SLIDE SHELF

OPTIONAL	PREZZO / PRICE	DESCRIZIONE / DESCRIPTION	PER / FOR
ME2	€ 175,00	Mensola scorriavassoi lato lungo Tray slide shelf, long side	2x1/1 GN
ME3	€ 192,00		3x1/1 GN
ME4	€ 246,00		4x1/1 GN



CARRELLI TERMICI ARMADIATI - VASCA UNICA

BAIN-MARIE CUPBOARD TROLLEYS - SINGLE WELL SEPARATE MIXED LOWER COMPARTMENTS WITH "C"- SHAPED RUNNERS

- Struttura in lamiera di acciaio inox AISI 304, finitura spazzolata
- Coibentazione realizzata con pannelli in poliuretano espanso
- Maniglie di spinta isolate
- Vasca bagnomaria unica stampata con bordi arrotondati, adatta a contenere bacinelle GN, fino a cm 20 h (escluse)
- Rubinetto per lo scarico dell'acqua del bagnomaria
- Vani inferiori, separati, riscaldati, refrigerati o neutri, termostattizzati indipendenti con sportelli coibentati apribili a bascula. N. 4 coppie di guide a "C" adatte ad ospitare bacinelle 1/1 GN o sottomultipli con una distanza di 7,6 cm
- Tensione rete 230 Volt monofase-50 Hz, 60 Hz a richiesta
- Riscaldamento a umido-bagnomaria, con resistenza esterna alla vasca
- Riscaldamento a secco: caratteristiche e costo a richiesta
- Refrigerazione ventilata +4°C+10°C
- Pannello comandi digitale IPX5 di serie, con termostati indipendenti, regolabili, uno per ogni elemento riscaldato o refrigerato
- Cavo spiralato lunghezza 3 mt. spina Schuko. Per potenze uguali o superiori a 3000W, il cavo viene fornito libero senza spina
- Paracolpi perimetrali in gomma grigia antitraccia
- Ruote ø cm 16, 2 fisse, 2 piroettanti con freno, supporto zincato, anello in gomma grigia antitraccia, rotolamento su cuscinetti

- AISI 304 stainless steel sheet construction, brushed finish
- Polyurethane foam insulation panels
- Heat-proof pushing handles
- Single Bain-Marie well in pressed steel sheet with no sharp edges for up to 20 cm-deep GN pans (not included)
- Bain-Marie drain tap
- Separate heated, refrigerated or neutral lower compartments with independent thermostats, insulated up-and-over doors. N. 4 pairs of "C"-shaped runners suitable for containers 1/1 GN (or submultiples) spaced 7.6 cm
- Mains supply: 230V, 50 Hz (60 Hz upon request), single-phase
- Bain-marie heating with heating element outside the well
- Dry heating: details and quotes upon request
- Ventilated refrigeration +4°C+10°C
- IPX5 digital control panel supplied as standard with independent thermostatic control - one thermostat for the well and for each heated or refrigerated compartment
- 3-m long coiled power cable, Schuko plug. For trolleys with power equal or above 3000W, the cable is supplied with no plug. For the plug, see optional item T200.
- All round grey non marking rubber bumpers
- 2 Fixed and 2 braked swivel castors with heavy-duty brackets, ø 16 cm; grey non marking rubber tread on centre with roller bearing hub

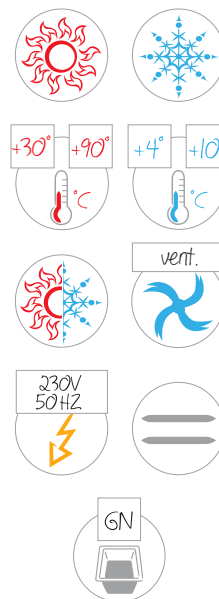

Optional + accessori vedi pag. 76-77
Optional + accessories: see pp. 76-77

Optional bacinelle vedi pag. 78-79
Optional Gastronorms: see pp. 78-79



N.B.: il pannello digitale IPX5 è di serie nei carrelli termici armadiati con guide stampate (serie "GS").

Note: IPX5 digital control panel is supplied as standard in the Bain-Marie trolleys with pressed runners ("GS" range)

Art. 7365A1F1

☐ = neutro = neutral
☀ = caldo = hot
❄ = freddo = cold

ARTICOLO / ARTICLE	PREZZO / PRICE	GN	VANO INF / LOWER COMP	POTENZA / POWER	MAX DIM. CM
7360A0F1	€ 4.591,00	2/1	❄	1450W	95x72x96 h
7365A0F2	€ 5.219,00	3/1	❄ ❄	1800W	134x72x96 h
7365A1F1	€ 5.621,00		☀ ❄	2350W	
7368A0F2	€ 6.245,00	4/1	☐ ❄ ❄	2700W	172x72x96 h
7368A1F2	€ 6.459,00		☀ ❄ ❄	3300W	
7368A2F1	€ 6.812,00		☀ ☀ ❄	3850W	

OPTIONAL	PREZZO / PRICE	📷	DESCRIZIONE / DESCRIPTION	PER / FOR
E	€ 97,00	1	Set 4 ruote elastiche, di cui 2 con freno, per pavimenti sconnessi o per esterni Set of 4 resilient wheels, 2 with brake for uneven floors / outdoor use	Tutti gli articoli All Articles

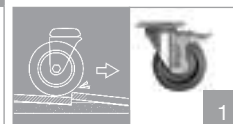

COPERCHIO

LID

Coperchi superiori isolati termicamente, aperti possono servire da piano d'appoggio
Struttura in lamiera di acciaio inox AISI 304, finitura spazzolata

*Insulated lids, when open they can be used as support
AISI 304 stainless steel sheet construction, brushed finish*

OPTIONAL	PREZZO / PRICE	DESCRIZIONE / DESCRIPTION	TIPOLOGIA / TYPOLOGY	PER / FOR
C2	€ 760,00	Coperchi superiori Top lids	apribili a 180° opening to 180°	2x1/1 GN
C3	€ 803,00			3x1/1 GN
L2	€ 793,00		apribili a 2/3 + 1/3: apertura con supporto a 180° oppure fino a 270° senza supporto	2x1/1 GN
L3	€ 884,00		opening to 2/3 + 1/3: opening up to 180° with supports or up to 270° without supports	3x1/1 GN
S2	€ 2.121,00		scorrevoli sliding	2x1/1 GN
S3	€ 2.350,00			3x1/1 GN



PARAFIATO

SNEEZE GUARD

OPTIONAL	PREZZO / PRICE		DESCRIZIONE / DESCRIPTION	TIPOLOGIA / TYPOLOGY	PER / FOR
PAR2L	€ 580,00	2	Parafiato in vetro Glass sneeze guard	Standard / Standard	2x1/1 GN
PAR2H	€ 651,00	3		Apertura "servi-piatti bambini" "Kid-service" opening	
PAR3L	€ 609,00	2		Standard / Standard	3x1/1 GN
PAR3H	€ 686,00	3		Apertura "servi-piatti bambini" "Kid-service" opening	
PAR4L	€ 687,00	2		Standard / Standard	4x1/1 GN
PAR4H	€ 703,00	3		Apertura "servi-piatti bambini" "Kid-service" opening	



MENSOLA SCORRIVASSOI

TRAY SLIDE SHELF

OPTIONAL	PREZZO / PRICE	DESCRIZIONE / DESCRIPTION	PER / FOR
ME2	€ 175,00	Mensola scorrevassoio lato lungo Tray slide shelf, long side	2x1/1 GN
ME3	€ 192,00		3x1/1 GN
ME4	€ 246,00		4x1/1 GN



CARRELLI TERMICI ARMADIATI - VASCA A TEMPERATURE DIFFERENZIATE

BAIN-MARIE CUPBOARD TROLLEYS - SEPARATE WELLS SINGLE NEUTRAL LOWER COMPARTMENT

- Struttura in lamiera di acciaio inox AISI 304, finitura spazzolata
- Coibentazione realizzata con pannelli in poliuretano espanso
- Maniglie di spinta isolate
- Vasche bagnomaria separate stampate con bordi arrotondati, adatte a contenere bacinelle GN, fino a cm 20 h (escluse)
- Rubinetto multiplo per lo scarico dell'acqua del bagnomaria
- Vano inferiore unico, neutro, con sportello apribile a bascula
- Tensione rete 230 Volt mono fase 50/60 Hz
- Riscaldamento sia a umido-bagnomaria che a secco (resistenza esterna alla vasca)
- Pannello comandi con termostati meccanici indipendenti, regolabili, uno per ogni vasca
- Cavo di alimentazione spiralato, lunghezza 3 metri, spina Schuko
- Paracolpi perimetrali in gomma grigia antitraccia
- Ruote ø cm 16, 2 fisse, 2 piroettanti con freno, supporto zincato, anello in gomma grigia antitraccia, rotolamento su cuscinetti

- AISI 304 stainless steel sheet construction, brushed finish
- Polyurethane foam insulation panels
- Heat-proof pushing handles
- Separate Bain-Marie wells in pressed steel sheet with no sharp edges for up to 20 cm deep GN pans (not included)
- Separate Bain-Marie drain taps
- Single lower neutral compartment with up-and-over door
- Mains supply: 230V, 50/60 Hz, single-phase
- Heating both wet-bain-marie and dry (external resistance to the tank)
- Control panel with independent mechanical adjustable thermostatic control, one thermostat for each well
- 3-mt long coiled power cable, Schuko plug
- All round grey non marking rubber bumpers
- 2 Fixed and 2 braked swivel castors with heavy-duty brackets, ø 16 cm; grey non marking rubber tread on centre with roller bearing hub

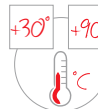

Optional + accessori vedi pag. 76-77
Optional + accessories: see pp. 76-77

Optional bacinelle vedi pag. 78-79
Optional Gastronorms: see pp. 78-79

Art. 7375A

☐ = neutro
☐ = neutral

ARTICOLO / ARTICLE	PREZZO / PRICE	GN	VARO INF / LOWER COMP	POTENZA / POWER	MAX DIM. CM
7370A	€ 2.888,00	2x1/1	☐	1000W	95x72x96 h
7375A	€ 3.588,00	3x1/1		1500W	134x72x96 h
7378A	€ 4.278,00	4x1/1		2000W	172x72x96 h

OPTIONAL	PREZZO / PRICE	📷	DESCRIZIONE / DESCRIPTION	PER / FOR
E	€ 97,00	1	Set 4 ruote elastiche, di cui 2 con freno, per pavimenti sconnessi o per esterni Set of 4 resilient wheels, 2 with brake for uneven floors / outdoor use	Tutti gli articoli All Articles

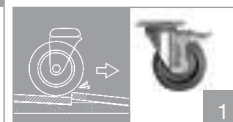

COPERCHIO

LID

Coperchi superiori isolati termicamente, aperti possono servire da piano d'appoggio
Struttura in lamiera di acciaio inox AISI 304, finitura spazzolata

*Insulated lids, when open they can be used as support
AISI 304 stainless steel sheet construction, brushed finish*

OPTIONAL	PREZZO / PRICE	DESCRIZIONE / DESCRIPTION	TIPOLOGIA / TYPOLOGY	PER / FOR
C2	€ 760,00	Coperchi superiori Top lids	apribili a 180° opening to 180°	2x1/1 GN
C3	€ 803,00			3x1/1 GN
L2	€ 793,00		apribili a 2/3 + 1/3: apertura con supporto a 180° oppure fino a 270° senza supporto	2x1/1 GN
L3	€ 884,00			3x1/1 GN
S2	€ 2.121,00		scorrevoli sliding	2x1/1 GN
S3	€ 2.350,00			3x1/1 GN



PARAFIATO

SNEEZE GUARD

OPTIONAL	PREZZO / PRICE		DESCRIZIONE / DESCRIPTION	TIPOLOGIA / TYPOLOGY	PER / FOR
PAR2L	€ 580,00	2	Parafiato in vetro Glass sneeze guard	Standard / Standard	2x1/1 GN
PAR2H	€ 651,00	3		Apertura "servi-piatti bambini" "Kid-service" opening	
PAR3L	€ 609,00	2		Standard / Standard	3x1/1 GN
PAR3H	€ 686,00	3		Apertura "servi-piatti bambini" "Kid-service" opening	
PAR4L	€ 687,00	2		Standard / Standard	4x1/1 GN
PAR4H	€ 703,00	3		Apertura "servi-piatti bambini" "Kid-service" opening	



MENSOLA SCORRIVASSOI

TRAY SLIDE SHELF

OPTIONAL	PREZZO / PRICE	DESCRIZIONE / DESCRIPTION	PER / FOR
ME2	€ 175,00	Mensola scorrevassoio lato lungo Tray slide shelf, long side	2x1/1 GN
ME3	€ 192,00		3x1/1 GN
ME4	€ 246,00		4x1/1 GN



CARRELLI TERMICI ARMADIATI - VASCA E VANI CON TEMPERATURE DIFFERENZIATE BAIN-MARIE CUPBOARD TROLLEYS - SEPARATE WELLS

- Struttura in lamiera di acciaio inox AISI 304, finitura spazzolata
- Coibentazione realizzata con pannelli in poliuretano espanso
- Maniglie di spinta isolate
- Vasche bagnomaria separate stampate con bordi arrotondati, adatte a contenere bacinelle GN, fino a cm 20 h (escluse)
- Rubinetto multiplo per lo scarico dell'acqua del bagnomaria
- Vani inferiori, separati, riscaldati o neutri, termostattizzati indipendenti con sportelli coibentati apribili a bascula. N. 4 coppie di guide a "C" adatte ad ospitare bacinelle 1/1 GN o sottomultipli con una distanza di 7,6 cm
- Tensione rete 230 Volt monofase-50/60 Hz
- Riscaldamento sia ad umido-bagnomaria, che a secco (resistenza esterna alla vasca)
- Pannello comandi con termostati meccanici indipendenti, regolabili uno per ogni elemento riscaldato
- Cavo spiralato lunghezza 3 mt. spina Schuko. Per potenze uguali o superiori a 3000W, il cavo viene fornito libero senza spina
- Paracolpi perimetrali in gomma grigia antitraccia
- Ruote ø cm 16, 2 fisse, 2 piroettanti con freno, supporto zincato, anello in gomma grigia antitraccia, rotolamento su cuscinetti

- AISI 304 stainless steel sheet construction, brushed finish
- Polyurethane foam insulation panels
- Heat-proof pushing handles
- Separate Bain-Marie wells in pressed steel sheet with no sharp edges for up to 20 cm deep GN pans (not included)
- Separate Bain-Marie drain taps
- Separate heated or neutral lower compartments with independent thermostats, insulated up-and-over doors. N. 4 pairs of "C"-shaped runners suitable for containers 1/1 GN (or submultiples) spaced 7.6 cm
- Mains supply: 230V, 50/60 Hz, single-phase
- Heating both wet bain-marie and dry (external resistance to the tank)
- Control panel with independent mechanical adjustable thermostatic control, one thermostat for each heated well/compartment
- 3-m long coiled power cable, Schuko plug. For trolleys with power equal or above 3000W, the cable is supplied with no plug. For the plug, see optional item T200.
- All round grey non marking rubber bumpers
- 2 Fixed and 2 braked swivel castors with heavy-duty brackets, ø 16 cm; grey non marking rubber tread on centre with roller bearing hub

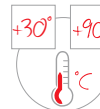

Optional + accessori vedi pag. 76-77
Optional + accessories: see pp. 76-77

Optional bacinelle vedi pag. 78-79
Optional Gastronorms: see pp. 78-79

Art. 7375A3

☐ = neutro
☐ = neutral
☀ = caldo
☀ = hot

ARTICOLO / ARTICLE	PREZZO / PRICE	GN	VANO INF / LOWER COMP	POTENZA / POWER	MAX DIM. CM
7370A0	€ 3.563,00	2x1/1	☐ ☐	1000W	95x72x96 h
7370A1	€ 3.692,00		☐ ☀	1600W	
7370A2	€ 3.825,00		☀ ☀	2400W	
7375A0	€ 4.680,00	3x1/1	☐ ☐ ☐	1500W	134x72x96 h
7375A1	€ 4.885,00		☐ ☐ ☀	2100W	
7375A2	€ 5.015,00		☐ ☀ ☀	2700W	
7375A3	€ 5.145,00		☀ ☀ ☀	3300W	
7378A0	€ 5.785,00	4x1/1	☐ ☐ ☐ ☐	2000W	172x72x96 h
7378A1	€ 5.913,00		☐ ☐ ☐ ☀	2600W	
7378A2	€ 6.045,00		☐ ☐ ☀ ☀	3200W	
7378A3	€ 6.177,00		☐ ☀ ☀ ☀	3800W	
7378A4	€ 6.307,00		☀ ☀ ☀ ☀	4400W	

OPTIONAL	PREZZO / PRICE	📷	DESCRIZIONE / DESCRIPTION	PER / FOR
E	€ 97,00	1	Set 4 ruote elastiche, di cui 2 con freno, per pavimenti sconnessi o per esterni Set of 4 resilient wheels, 2 with brake for uneven floors / outdoor use	Tutti gli articoli All Articles

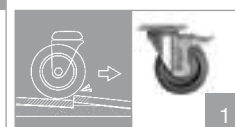

COPERCHIO

LID

Coperchi superiori isolati termicamente, aperti possono servire da piano d'appoggio
Struttura in lamiera di acciaio inox AISI 304, finitura spazzolata

*Insulated lids, when open they can be used as support
AISI 304 stainless steel sheet construction, brushed finish*

OPTIONAL	PREZZO / PRICE	DESCRIZIONE / DESCRIPTION	TIPOLOGIA / TYPOLOGY	PER / FOR
C2	€ 760,00	Coperchi superiori Top lids	apribili a 180° opening to 180°	2x1/1 GN
C3	€ 803,00			3x1/1 GN
L2	€ 793,00		apribili a 2/3 + 1/3: apertura con supporto a 180° oppure fino a 270° senza supporto	2x1/1 GN
L3	€ 884,00		opening to 2/3 + 1/3: opening up to 180° with supports or up to 270° without supports	3x1/1 GN
S2	€ 2.121,00		scorrevoli sliding	2x1/1 GN
S3	€ 2.350,00			3x1/1 GN



PARAFIATO

SNEEZE GUARD

OPTIONAL	PREZZO / PRICE		DESCRIZIONE / DESCRIPTION	TIPOLOGIA / TYPOLOGY	PER / FOR
PAR2L	€ 580,00	2	Parafiato in vetro Glass sneeze guard	Standard / Standard	2x1/1 GN
PAR2H	€ 651,00	3		Apertura "servi-piatti bambini" "Kid-service" opening	
PAR3L	€ 609,00	2		Standard / Standard	3x1/1 GN
PAR3H	€ 686,00	3		Apertura "servi-piatti bambini" "Kid-service" opening	
PAR4L	€ 687,00	2		Standard / Standard	4x1/1 GN
PAR4H	€ 703,00	3		Apertura "servi-piatti bambini" "Kid-service" opening	



MENSOLA SCORRIVASSOI

TRAY SLIDE SHELF

OPTIONAL	PREZZO / PRICE	DESCRIZIONE / DESCRIPTION	PER / FOR
ME2	€ 175,00	Mensola scorriavassoi lato lungo Tray slide shelf, long side	2x1/1 GN
ME3	€ 192,00		3x1/1 GN
ME4	€ 246,00		4x1/1 GN



CARRELLI TERMICI ARMADIATI - VASCA E VANI CON TEMPERATURE DIFFERENZIATE BAIN-MARIE CUPBOARD TROLLEYS - SEPARATE WELLS

- Struttura in lamiera di acciaio inox AISI 304, finitura spazzolata
- Coibentazione realizzata con pannelli in poliuretano espanso
- Maniglie di spinta isolate
- Vasche bagnomaria separate stampate con bordi arrotondati, adatte a contenere bacinelle GN, fino a cm 20 h (escluse)
- Rubinetto multiplo per lo scarico dell'acqua del bagnomaria
- Vani inferiori, separati, riscaldati, refrigerati o neutri, termostattizzati indipendenti con sportelli coibentati apribili a bascula. N. 4 coppie di guide a "C" adatte ad ospitare bacinelle 1/1 GN o sottomultipli con una distanza di 7,6 cm
- Tensione rete 230 Volt monofase-50 Hz, 60 Hz a richiesta
- Riscaldamento sia ad umido-bagnomaria, che a secco (resistenza esterna alla vasca)
- Refrigerazione ventilata +4°C+10°C
- Pannello comandi digitale IPX5 di serie, con termostati indipendenti regolabili, uno per ogni elemento riscaldato o refrigerato
- Cavo spiralato lunghezza 3 mt. spina Schuko. Per potenze uguali o superiori a 3000W, il cavo viene fornito libero senza spina
- Paracolpi perimetrali in gomma grigia antitraccia
- Ruote ø cm 16, 2 fisse, 2 piroettanti con freno, supporto zincato, anello in gomma grigia antitraccia, rotolamento su cuscinetti

- AISI 304 stainless steel sheet construction, brushed finish
- Polyurethane foam insulation panels
- Heat-proof pushing handles
- Separate Bain-Marie wells in pressed steel sheet with no sharp edges for up to 20 cm deep GN pans (not included)
- Separate Bain-Marie drain taps
- Separate heated, refrigerated or neutral lower compartments with independent thermostats, insulated up-and-over doors. N. 4 pairs of "C"-shaped runners suitable for containers 1/1 GN (or submultiples) spaced 7.6 cm
- Mains supply: 230V, 50 Hz (60 Hz upon request), single-phase
- Heating both wet bain-marie and dry (external resistance to the tank)
- Ventilated refrigeration +4°C+10°C
- IPX5 digital control panel supplied as standard with independent thermostatic control - one thermostat for each well and for each heated or refrigerated compartment
- 3-m long coiled power cable, Schuko plug. For trolleys with power equal or above 3000W, the cable is supplied with no plug. For the plug, see optional item T200.
- All round grey non marking rubber bumpers
- 2 Fixed and 2 braked swivel castors with heavy-duty brackets, ø 16 cm; grey non marking rubber tread on centre with roller bearing hub

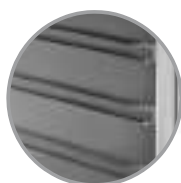
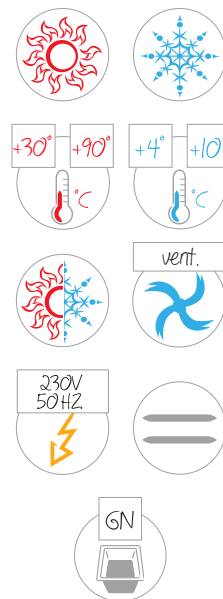

Optional + accessori vedi pag. 76-77
Optional + accessories: see pp. 76-77

Optional bacinelle vedi pag. 78-79
Optional Gastronorms: see pp. 78-79



N.B.: il pannello digitale IPX5 è di serie nei carrelli termici armadiati con guide stampate (serie "GS").

Note: IPX5 digital control panel is supplied as standard in the Bain-Marie trolleys with pressed runners ("GS" range)

Art. 7375A1F1

☐ = neutro = neutral
☀ = caldo = hot
❄ = freddo = cold

ARTICOLO / ARTICLE	PREZZO / PRICE	GN	VANO INF / LOWER COMP	POTENZA / POWER	MAX DIM. CM
7370A0F1	€ 4.870,00	2x1/1	❄	1450W	95x72x96 h
7375A0F2	€ 5.856,00	3x1/1	❄ ❄	2100W	134x72x96 h
7375A1F1	€ 6.275,00		☀ ❄	2450W	
7378A0F2	€ 6.963,00	4x1/1	☐ ❄ ❄	2700W	172x72x96 h
7378A1F2	€ 7.177,00		☀ ❄ ❄	3100W	
7378A2F1	€ 7.529,00		☀ ☀ ❄	3600W	

OPTIONAL	PREZZO / PRICE	📷	DESCRIZIONE / DESCRIPTION	PER / FOR
E	€ 97,00	1	Set 4 ruote elastiche, di cui 2 con freno, per pavimenti sconnessi o per esterni Set of 4 resilient wheels, 2 with brake for uneven floors / outdoor use	Tutti gli articoli All Articles

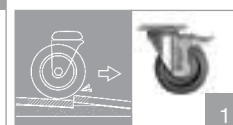

COPERCHIO

LID

Coperchi superiori isolati termicamente, aperti possono servire da piano d'appoggio
Struttura in lamiera di acciaio inox AISI 304, finitura spazzolata

*Insulated lids, when open they can be used as support
AISI 304 stainless steel sheet construction, brushed finish*

OPTIONAL	PREZZO / PRICE	DESCRIZIONE / DESCRIPTION	TIPOLOGIA / TYPOLOGY	PER / FOR
C2	€ 760,00	Coperchi superiori Top lids	apribili a 180° opening to 180°	2x1/1 GN
C3	€ 803,00			3x1/1 GN
L2	€ 793,00		apribili a 2/3 + 1/3: apertura con supporto a 180° oppure fino a 270° senza supporto	2x1/1 GN
L3	€ 884,00		opening to 2/3 + 1/3: opening up to 180° with supports or up to 270° without supports	3x1/1 GN
S2	€ 2.121,00		scorrevoli sliding	2x1/1 GN
S3	€ 2.350,00			3x1/1 GN



PARAFIATO

SNEEZE GUARD

OPTIONAL	PREZZO / PRICE		DESCRIZIONE / DESCRIPTION	TIPOLOGIA / TYPOLOGY	PER / FOR
PAR2L	€ 580,00	2	Parafiato in vetro Glass sneeze guard	Standard / Standard	2x1/1 GN
PAR2H	€ 651,00	3		Apertura "servi-piatti bambini" "Kid-service" opening	
PAR3L	€ 609,00	2		Standard / Standard	3x1/1 GN
PAR3H	€ 686,00	3		Apertura "servi-piatti bambini" "Kid-service" opening	
PAR4L	€ 687,00	2		Standard / Standard	4x1/1 GN
PAR4H	€ 703,00	3		Apertura "servi-piatti bambini" "Kid-service" opening	



MENSOLA SCORRIVASSOI

TRAY SLIDE SHELF

OPTIONAL	PREZZO / PRICE	DESCRIZIONE / DESCRIPTION	PER / FOR
ME2	€ 175,00	Mensola scorrevassoio lato lungo Tray slide shelf, long side	2x1/1 GN
ME3	€ 192,00		3x1/1 GN
ME4	€ 246,00		4x1/1 GN



OPTIONAL E ACCESSORI
ACCESSORIES AND OPTIONAL PARTS

OPTIONAL PANNELLO COMANDI

Pannello comandi con protezione IPX5 (*) Interruttore di accensione Termostattizzazione digitale.

(*) Nei carrelli termici con 1 o più vani inferiori refrigerati o con guide stampate (serie "GS") il pannello IPX5 è di serie.



OPTIONAL CONTROL PANEL

Control panel with IPX5 protection (*) ON/OFF digital switch thermostatic control

(*) The IPX5 control panel is supplied as standard in the Bain-Marie trolleys featuring one or more lower refrigerated compartments or lower compartments with pressed runners ("GS" range).

	T0100	T0102	T0104	T0106	T0108	T0110	T0112	T0114	T0116	T0118	T0120	T0122	T0124	T0126	T0128	T0130	T0132
€	122,00	173,00	233,00	289,00	272,00	173,00	222,00	282,00	222,00	272,00	332,00	391,00	252,00	299,00	356,00	410,00	465,00
7360A	✓																
7365A	✓																
7368A	✓																
7360A0	✓																
7360A1		✓															
7360A2			✓														
7365A0	✓																
7365A1		✓															
7365A2			✓														
7365A3				✓													
7368A0	✓																
7368A1		✓															
7368A2			✓														
7368A3				✓													
7368A4					✓												
7370A						✓											
7375A									✓								
7370A0						✓											
7370A1							✓										
7370A2								✓									
7375A0								✓									
7378A													✓				
7375A1									✓								
7375A2										✓							
7375A3											✓						
7378A0												✓					
7378A1													✓				
7378A2														✓			
7378A3															✓		
7378A4																	✓

OPTIONAL SPINA MOBILE

OPTIONAL POWER PLUG

OPTIONAL	PREZZO / PRICE	DESCRIZIONE / DESCRIPTION
T200	€ 57,00	Spina mobile 2P+T-6h/250V - 16 A - IP67 (IEC 309) per potenze fino a 3450W <i>Mobile plug 2P+E-6h/250V - 16 A - IP67 (IEC 309) for powers up to 3450W</i>



OPTIONAL TIMONE

OPTIONAL TOW BAR

OPTIONAL	PREZZO / PRICE	DESCRIZIONE / DESCRIPTION
T-2018	€ 869,00	Timone per traino con gancio per tutti i carrelli termici armadiati NB: non compatibile con accessorio parafiato: Art. PAR2L - PAR2H - PAR3L - PAR3H - PA4L - PAR4H <i>Tow bar with coupler for all bain-marie cupboard trolleys Note: this item is not compatible with accessory sneeze guard: Art. PAR2L - PAR2H - PAR3L - PAR3H - PA4L - PAR4H</i>



ACCESSORIO PIASTRA EUTETTICA

ACCESSORY EUTECTIC PLATE

ACCESSORIO / ACCESSORY	PREZZO / PRICE	DESCRIZIONE / DESCRIPTION
T0030	€ 160,00	Piastra eutettica GN (-10°C) per vani inferiori neutri <i>GN eutectic plate (-10 °C) for neutral lower compartments</i>



BACINELLE GASTRONORM IN ACCIAIO INOX STAINLESS STEEL GASTRONORM CONTAINERS, LIDS AND DIVIDERS

I carrelli termici per la distribuzione dei pasti, così come i Buffet, i carrelli bagnomaria e alcuni tipi di piani caldi, sono progettati in base agli standard dimensionali delle bacinelle Gastronorm. Le bacinelle Gastronorm in acciaio inox sono largamente usate nella ristorazione per contenere qualsiasi tipo di cibo e possono essere dotate di coperchi.

Per disporre più bacinelle all'interno delle vasche dei carrelli, sono necessari i separatori.

Bain-Marie units for meal distribution, as well as self-service buffet trolleys, Bain-Marie trolleys and a few types of hotplates are designed in compliance with Gastronorm size standards.

Stainless steel Gastronorm containers are widely used in the catering industry for food storage. Lids are also available. Dividers are needed to fit a number of containers into the trolley wells.



DIMENSIONI BACINELLE GASTRONORM GASTRONORM CONTAINERS SIZES

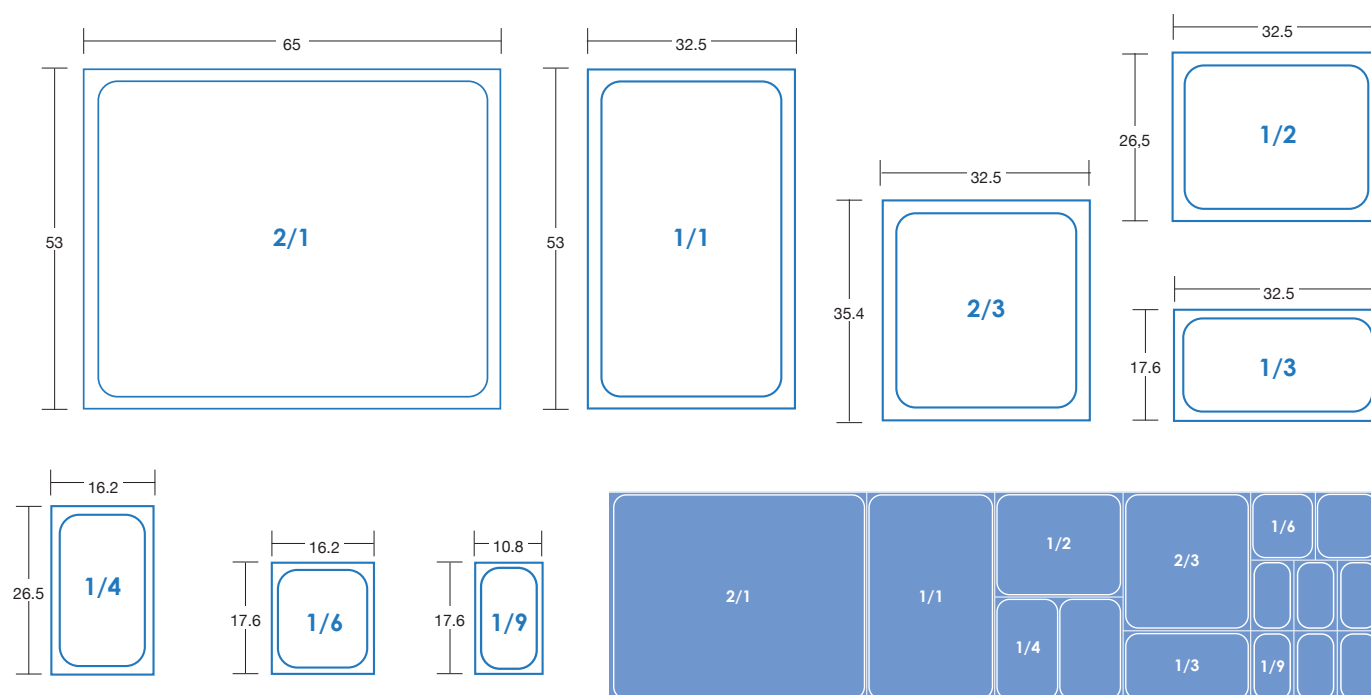

COPERCHI PER BACINELLE GASTRONORM LIDS FOR GASTRONORM CONTAINERS

ARTICOLO / ARTICLE	PREZZO / PRICE	GN	MAX DIM. CM
B0190	€ 27,00	1/1	32,5x53
B0290	€ 23,00	2/3	32,5x35,4
B0390	€ 18,00	1/2	26,5x32,5
B0490	€ 15,00	1/3	17,6x32,5
B0590	€ 13,00	1/4	26,5x16,2
B0690	€ 12,00	1/6	17,6x16,2

SEPARATORI PER BACINELLE GASTRONORM DIVIDERS FOR GASTRONORM CONTAINERS

ARTICOLO / ARTICLE	PREZZO / PRICE	GN	MAX DIM. CM
B0002	€ 15,00	1/1	53
B0004	€ 13,00	1/2	32,5

BACINELLE GASTRONORM IN ACCIAIO INOX
STAINLESS STEEL GASTRONORM CONTAINERS, LIDS AND DIVIDERS

ARTICOLO / ARTICLE	PREZZO / PRICE	GN	H CM	MAX DIM. CM
B0010	€ 64,00	2/1	2	65x53
B0020	€ 71,00		4	
B0030	€ 75,00		6,5	
B0040	€ 98,00		10	
B0050	€ 134,00		15	
B0060	€ 152,00		20	
B0110	€ 32,00	1/1	2	32,5x53
B0120	€ 35,00		4	
B0130	€ 41,00		6,5	
B0140	€ 49,00		10	
B0150	€ 68,00		15	
B0160	€ 81,00		20	
B0210	€ 21,00	2/3	2	32,5x35,4
B0220	€ 27,00		4	
B0230	€ 32,00		6,5	
B0240	€ 41,00		10	
B0250	€ 49,00		15	
B0260	€ 56,00		20	
B0310	€ 18,00	1/2	2	26,5x32,5
B0320	€ 21,00		4	
B0330	€ 25,00		6,5	
B0340	€ 33,00		10	
B0350	€ 41,00		15	
B0360	€ 49,00		20	
B0410	€ 14,00	1/3	2	17,6x32,5
B0420	€ 18,00		4	
B0430	€ 21,00		6,5	
B0440	€ 26,00		10	
B0450	€ 34,00		15	
B0460	€ 37,00		20	
B0510	€ 12,00	1/4	2	26,5x16,2
B0520	€ 15,00		4	
B0530	€ 17,00		6,5	
B0540	€ 23,00		10	
B0550	€ 27,00		15	
B0560	€ 36,00		20	
B0630	€ 18,00	1/6	6,5	17,6x16,2
B0640	€ 21,00		10	
B0650	€ 26,00		15	
B0660	€ 43,00		20	
B0730	€ 15,00	1/9	6,5	17,6x10,8
B0740	€ 21,00		10	





ARMADI PORTAVASSOI / PORTATEGLIE NEUTRI

PAG. 82

NEUTRAL TRAY/PAN MOBILE CUPBOARDS



ARMADI PORTATEGLIE RISCALDATI E REFRIGERATI

PAG. 83

HEATED AND REFRIGERATED TRAY/PAN MOBILE CUPBOARDS



ARMADI PORTAVASSOI / PORTATEGLIE NEUTRI, COIBENTATI, RISCALDATI

PAG. 88

NEUTRAL, INSULATED, HEATED TRAY/PAN MOBILE CUPBOARDS

ARMADI PORTAVASSOI - PORTATEGLIE NEUTRI NEUTRAL TRAY/PAN MOBILE CUPBOARDS

- Struttura in lamiera di acciaio inox AISI 304, finitura spazzolata
- 1 sportello frontale a battente apribile a 270°, con magnete di bloccaggio a porta aperta
- Maniglia di apertura con chiusura a calamita
- Coppia di maniglie di spinta con supporti in PVC e tubo di presa in acciaio inox posizionate su un lato
- Supporti in lamiera di acciaio inox a "C" o a "L" per vassoi-teglie di differenti forme e misure
- Paracolpi perimetrale in gomma grigia antitraccia
- Ruote ø cm 12,5 piroettanti, di cui 2 con freno

- *AISI 304 stainless steel sheet construction, brushed finish*
- *1 front hinged door opening to 270° with magnet (to keep the door open)*
- *Snap closure handle*
- *2 Stainless steel tubular pushing bars with PVC brackets on one side*
- *"C"-shaped or "L"-shaped stainless steel sheet supports for trays/containers of various shapes and sizes*
- *All round grey non marking rubber bumper*
- *Swivel castors - ø 12.5 cm, 2 with brake*

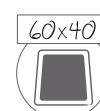

Art. 3342GN

ARTICOLO / ARTICLE	PREZZO / PRICE	PORT. VASSOI-TEGLIE / TRAY-CONTAINER CAP	SUPPORTO / RUNNERS	PASSO CM / SHELF SPACING	MAX DIM. CM
3342GN	€ 1.098,00	10 GN 1/1	L	11	52x65x142 h
3342EN	€ 1.119,00	10 EN			56x65x142 h
3343	€ 1.212,00	15 GN 1/1	C	7,5	52x65x142 h
3345	€ 1.439,00	15 GN 2/1			72x77x142 h
3344	€ 1.344,00	18 - 60x40 cm	L	6,5	59x77x145 h

OPTIONAL	PREZZO / PRICE	📷	DESCRIZIONE / DESCRIPTION	PER / FOR	
E	€ 97,00	1	Set 4 ruote elastiche, di cui 2 con freno, per pavimenti sconnessi o per esterno Set with 4 resilient castors, 2 with brake, for uneven floors / outdoor use	Tutti gli articoli All Articles	 1

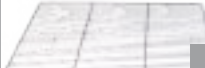
ACCESSORI / ACCESSORIES	PREZZO / PRICE	📷	DESCRIZIONE / DESCRIPTION	PER / FOR	
A0170	€ 47,00	2	Griglia in filo inox 1/1 GN 1/1 GN stainless steel wire shelf	3343	 2
A0171	€ 76,00	3	Griglia in filo inox 2/1 GN 2/1 GN stainless steel wire shelf	3345	 3

- Struttura in acciaio inox AISI 304, coibentata, finitura spazzolata
- 1 Sportello frontale a battente, apribile a 270°, con magnete di bloccaggio a porta aperta
- Guarnizione sportello estraibile
- Maniglia di apertura con chiusura a scatto, optional con serratura
- Maniglia di spinta
- Vano interno con angoli arrotondati (soddisfa il requisito igienico H1) predisposto per teglie GN
- Gruppo riscaldante ventilato con motoventilatore e resistenza
- Pannello comandi integrato, dotato di interruttore di accensione con spia luminosa, termostato-termometro digitale, sul retro cavo di alimentazione spiralato
- Tensione rete 230 Volt monofase – 50/60Hz
- Possibilità di umidificare il vano interno tramite apposita vaschetta con acqua
- Paracolpi perimetrale in gomma grigia antiraccia
- Ruote ø cm 12,5 piroettanti, di cui 2 con freno

- AISI 304 stainless steel insulated structure, brushed finish
- 270° opening front door with magnet (to keep the door open)
- Removable door gasket
- Handle with snap closure, optional with lock
- Pushing handle
- Inside compartment made with round corners in compliance with H1 hygiene standard, suitable for GN containers
- Ventilated heating unit powered with fan and heating element
- Control panel with ON/OFF switch with operation warning light and digital thermostat, coiled power cord on the backside
- Mains supply: 230V - 50 Hz (60 Hz upon request), single-phased
- Water container to release moisture inside the cupboard
- All round grey non marking rubber bumper
- Swivel castors, ø cm 12.5, 2 with brake



Guide stampate
Costruite con un unico foglio di lamiera, facilitano la pulizia

Pressed runners
made with one single sheet layer for easy cleaning



Vano con angoli arrotondati
soddisfano il requisito igienico "H1"

Compartment with no-sharp edges
compliant with "H1" hygiene system



Porta apribile a 270°
Facilita l'inserimento delle bacinelle GN
270° opening door
To easily fit GN pans

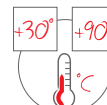

Art. 3411-20GS

Art. 3421-10GS



ARTICOLO / ARTICLE	PREZZO / PRICE	TIPOLOGIA / TYPOLOGY	GN	SUPPORTO / RUNNERS	PASSO / SPACING CM	POTENZA / POWER	MAX DIM. CM
3411-10GS	€ 3.496,00		10 GN 1/1		5.5	1600W	55x80x110 h
3421-10GS	€ 3.854,00		10 GN 2/1				72x92x110 h
3411-20GS	€ 4.193,00		20 GN 1/1				55x80x166 h
3421-20GS	€ 4.624,00		20 GN 2/1				72x92x166 h

OPTIONAL	PREZZO / PRICE		DESCRIZIONE / DESCRIPTION	PER / FOR
E	€ 97,00	1	Set 4 ruote elastiche, di cui 2 con freno, per pavimenti sconnessi o per esterno Set with 4 resilient castors, 2 with brake, for uneven floors / outdoor use	Tutti gli articoli All Articles
MA	€ 126,00	-	Maniglia di chiusura con serratura Closure handle with lock	1

ACCESSORI / ACCESSORIES	PREZZO / PRICE		DESCRIZIONE / DESCRIPTION	PER / FOR
A0170	€ 47,00	2	Griglia in filo inox 1/1 GN 1/1 GN stainless steel wire shelf	3411-10GS / 3411-20GS
A0171	€ 76,00	3	Griglia in filo inox 2/1 GN 2/1 GN stainless steel wire shelf	3421-10GS / 3421-20GS

ARMADIO PORTATEGLIE CALDO DISPENSA VIVANDE HEATED INSULATED PAN MOBILE CUPBOARD

- Struttura in lamiera di acciaio inox AISI 304, coibentata, finitura spazzolata
- 1 Sportello frontale a battente, apribile a 270°, con magneti di bloccaggio a porta aperta
- Guarnizione sportello estraibile
- Maniglia di apertura con chiusura a scatto, optional con serratura
- Maniglia di spinta
- Coperchio ribaltabile a 180°, aperto funge da piano di appoggio
- Mensola laterale portabacinelle 1/1 GN, ribaltabile
- Vano interno con angoli arrotondati (soddisfa il requisito igienico H1) predisposto per teglie 1/1 GN
- Gruppo riscaldante ventilato con motoventilatore e resistenza
- Pannello comandi integrato, dotato di interruttore di accensione con spia luminosa, termostato-termometro digitale, sul retro cavo di alimentazione spiralato
- Tensione rete 230 Volt monofase – 50/60Hz
- Paracolpi perimetrale in gomma grigia antitraccia
- Ruote ø cm 12,5 piroettanti, di cui 2 con freno

- AISI 304 stainless steel insulated structure, brushed finish
- 270° opening front door with magnet (to keep the door open)
- Removable door gasket
- Handle with snap closure, optional with lock
- Pushing handle
- 180° opening lid, when open it acts as a support surface
- Side drop-down shelf for GN 1/1 containers
- Inside compartment made with round corners in compliance with H1 hygiene standard, suitable for GN 1/1 containers
- Ventilated heating unit powered with fan and heating element
- Control panel with ON/OFF switch with operation warning light and digital thermostat, coiled power cord on the backside
- Mains supply: 230V - 50 Hz (60 Hz upon request), single-phased
- All round grey non marking rubber bumper
- Swivel castors, ø cm 12.5, 2 with brake



Guide stampate

Costruite con un unico foglio di lamiera, facilitano la pulizia

Pressed runners

made with one single sheet layer for easy cleaning



Vano con angoli arrotondati soddisfano il requisito igienico "H1"

Compartment with no-sharp edges compliant with "H1" hygiene system



Porta apribile a 270°

Facilita l'inserimento delle bacinelle GN

270° opening door To easily fit GN pans

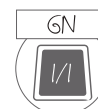
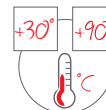

Art. 3411-11GS

ARTICOLO / ARTICLE	PREZZO / PRICE	TIPOLOGIA / TYPOLOGY	GN	SUPPORTO / RUNNERS	PASSO / SPACING CM	POTENZA / POWER	MAX DIM. CM
3411-11GS	€ 4.521,00		11 GN 1/1		5.5	900W	59x85x117 h

OPTIONAL	PREZZO / PRICE		DESCRIZIONE / DESCRIPTION	
E	€ 97,00	1	Set 4 ruote elastiche, di cui 2 con freno, per pavimenti sconnessi o per esterno Set with 4 resilient castors, 2 with brake, for uneven floors / outdoor use	
MA	€ 126,00	-	Maniglia di chiusura con serratura Closure handle with lock	
ACCESSORI / ACCESSORIES	PREZZO / PRICE		DESCRIZIONE / DESCRIPTION	
A0170	€ 47,00	2	Griglia in filo inox 1/1 GN 1/1 GN stainless steel wire shelf	

ARMADIO MANTENITORE CALDO CON STRUTTURA RINFORZATA PER USO INTENSIVO HEATED INSULATED MOBILE CUPBOARD - reinforced construction for heavy-duty use

- Struttura in lamiera di acciaio inox AISI 304, finitura spazzolata
- Telaio esterno con spessore maggiorato
- Costruzione in doppia parete
- Coibentazione realizzata con pannelli in poliuretano espanso
- 1 sportello frontale a battente, apribile a 270°, con magneti di bloccaggio a porta aperta
- Maniglia di apertura con chiusura a scatto, optional con serratura
- Guarnizione sportello estraibile senza l'ausilio di attrezzi
- Coppia di maniglie di spinta, isolate
- Vano interno con angoli arrotondati, soddisfa il requisito igienico H1, predisposto per teglie GN e sottomultipli
- Pannello comandi dotato di: interruttore di accensione con spia luminosa di presenza

- AISI 304 stainless steel sheet construction, brushed finish
- AISI 304 stainless steel outside frame with reinforced thickness
- Double-wall construction
- Polyurethane foam insulation panels
- 1 front hinged door, opening to 270°
- Handle with snap closure, optional with lock
- Door seal removable without the use of tools
- 2 insulated handles
- Interior compartment with no-sharp edges (compliant with H1 hygiene standard) suitable for containers GN (or submultiples)
- Control panel equipped with ON/OFF switch with operation warning light, digital thermostat / thermometer, red light to signal working heating element
- Max. operating temperature +90°, thermostat-controlled temperature between +30° and +90°
- Ventilated heating unit powered with motor fan and heating element
- Water container to release moisture inside the cupboard
- 3 mt length coiled power cable with Schuko plug
- Main supply: 230 V – 50/60 Hz single-phased
- Total power 1600W
- Heavy-Duty HDPE structural base to work as bumper
- 4 resilient swivel castors Ø mm 125, 2 with brake

- alimentazione, termostato-termometro digitale, spia rossa per segnalare resistenza in funzione
- Temperatura massima di esercizio 90°, controllata da termostato regolabile fra 30° e 90°
- Riscaldamento tramite gruppo ventilato con motoventilatore e resistenza.
- Possibilità di umidificare il vano interno tramite apposita vaschetta raccolta acqua
- Cavo di alimentazione spiralato, lunghezza 3 metri, completo di spina Schuko
- Tensione rete 230 Volt monofase-50/60 Hz
- Potenza totale 1600W
- Base di rinforzo in HDPE con funzione di paracolpo
- Ruote elastiche Ø mm 125 piroettanti, di cui 2 con freno per art. 3411-20GS.R
- Ruote elastiche Ø mm 160 piroettanti, di cui 2 con freno per art. 3421-20GS.R

**NOVITÀ
NEW**



Guide stampate
Costruite con un unico foglio di lamiera, facilitano la pulizia

Pressed runners
made with one single sheet layer for easy cleaning

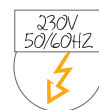
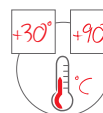

Vano con angoli arrotondati
soddisfano il requisito igienico "H1"

Compartment with no-sharp edges
compliant with "H1" hygiene system

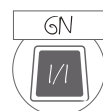

Art. 3411-20GS.R

ARTICOLO / ARTICLE	PREZZO / PRICE	TIPOLOGIA / TYPOLOGY	GN	SUPPORTO / RUNNERS	PASSO / SPACING CM	POTENZA / POWER	MAX DIM. CM
3411-20GS.R	€ 4.822,00		20 GN 1/1		5.5	1600W	55x80x110 h
3421-20GS.R	€ 5.318,00		20 GN 2/1				72x92x110 h

OPTIONAL	PREZZO / PRICE		DESCRIZIONE / DESCRIPTION	PER / FOR
MA	€ 126,00	-	Maniglia di chiusura con serratura Closure handle with lock	Tutti gli articoli All Articles

ACCESSORI / ACCESSORIES	PREZZO / PRICE		DESCRIZIONE / DESCRIPTION	PER / FOR	
A0170	€ 47,00	2	Griglia in filo inox 1/1 GN 1/1 GN stainless steel wire shelf	3411-10GS / 3411-20GS	2
A0171	€ 76,00	3	Griglia in filo inox 2/1 GN 2/1 GN stainless steel wire shelf	3421-10GS / 3421-20GS	3

ARMADIO PORTATEGLIE REFRIGERATO REFRIGERATED INSULATED PAN MOBILE CUPBOARD

- Struttura in acciaio inox AISI 304 coibentata, finitura spazzolata
 - 1 Sportello frontale a battente, apribile a 270° con magneti di bloccaggio a porta aperta
 - Maniglia di apertura con chiusura a scatto, optional con serratura
 - Maniglie di spinta
 - Vano interno con angoli arrotondati (soddisfa il requisito igienico H1) dotato di 16 coppie di guide stampate, predisposto per teglie 1/1 GN.
 - Refrigerazione ventilata +2°C +10°C
 - Sbrinatorio ed evaporazione condensa automatici
 - Pannello comandi integrato dotato di interruttore di accensione con spia luminosa e termostato digitale, sul retro cavo di alimentazione spiralato
 - Tensione rete 230 Volt monofase – 50/60Hz
 - Paracolpi perimetrale in gomma grigia antiraccia
 - Ruote ø cm 12,5, piroettanti, di cui 2 con freno
- AISI 304 stainless steel insulated structure, brushed finish
 - 270° opening front door with magnet (to keep the door open)
 - Handle with snap closure, optional with lock
 - Pushing handles
 - Inside compartment equipped with 16 pressed runners suitable for 1/1 GN containers made with round corners in compliance with H1 hygiene standard
 - Ventilated refrigeration +2°C +10°C
 - Automatic defrosting and evaporation
 - Control panel with ON/OFF switch with operation warning light and digital thermostat, coiled power cord on the backside
 - Mains supply: 230V - 50Hz, 60Hz upon request
 - All round grey non marking rubber bumper
 - Swivel castors, ø cm 12.5, 2 with brake



Guide stampate

Costruite con un unico foglio di lamiera, facilitano la pulizia

Pressed runners

made with one single sheet layer for easy cleaning



Vano con angoli arrotondati soddisfano il requisito igienico "H1"

Compartment with no-sharp edges compliant with "H1" hygiene system



Porta apribile a 270°

Facilita l'inserimento delle bacinelle GN

270° opening door To easily fit GN pans

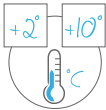

Art. 3415-16GS

ARTICOLO / ARTICLE	PREZZO / PRICE	TIPOLOGIA / TYPOLOGY	GN	SUPPORTO / RUNNERS	PASSO / SPACING CM	POTENZA / POWER	MAX DIM. CM
3415-16GS	€ 5.860,00		16 x 1/1 GN		5.5	330W	55,5x79,5x165 h

OPTIONAL	PREZZO / PRICE		DESCRIZIONE / DESCRIPTION	
E	€ 97,00	1	Set 4 ruote elastiche, di cui 2 con freno, per pavimenti sconnessi o per esterno Set with 4 resilient castors, 2 with brake, for uneven floors / outdoor use	
MA	€ 126,00	-	Maniglia di chiusura con serratura Closure handle with lock	
ACCESSORI / ACCESSORIES	PREZZO / PRICE		DESCRIZIONE / DESCRIPTION	
A0170	€ 47,00	2	Griglia in filo inox 1/1 GN 1/1 GN stainless steel wire shelf	

ARMADIO REFRIGERATO CON STRUTTURA RINFORZATA PER USO INTENSIVO
REFRIGERATED INSULATED MOBILE CUPBOARD WITH REINFORCED CONSTRUCTION FOR HEAVY-DUTY USE

- Struttura in lamiera di acciaio inox AISI 304, finitura spazzolata
- Telaio esterno con spessore maggiorato
- Costruzione in doppia parete
- Coibentazione realizzata in poliuretano espanso
- 1 sportello frontale a battente, apribile a 270°, con magneti di bloccaggio a porta aperta
- Maniglia di apertura con chiusura a scatto, optional con serratura
- Coppia di maniglie di spinta, isolate
- Guarnizione sportello estraibile senza l'ausilio di attrezzi
- Vano interno con angoli arrotondati, che soddisfa il requisito igienico H1
- Pannello comandi integrato dotato di interruttore di accensione con spia luminosa e termostato-termometro digitale
- Refrigerazione ventilata +2°C +10°C
- Sbrinamento ed evaporazione condensa automatici
- Cavo di alimentazione spiralato, lunghezza 3 metri, completo di spina Schuko
- Tensione rete 230 Volt monofase 50/60 Hz
- Potenza 330W
- Base di rinforzo in HDPE con funzione di paracolpo
- Ruote elastiche Ø mm 125 piroettanti, di cui 2 con freno

- AISI 304 stainless steel sheet construction, brushed finish
- AISI 304 stainless steel outside frame with reinforced thickness
- Double-wall construction
- Polyurethane foam insulation
- 1 front hinged door, opening to 270°
- Handle with snap closure, optional with lock
- Door seal removable without the use of tools
- 2 insulated handles
- Door seal removable without the use of tools
- Interior compartment with no-sharp edges (compliant with H1 hygiene standard)
- Built-in control panel with ON/OFF switch with operation warning light and digital thermostat/ thermometer
- Ventilated refrigeration +2° +10°
- Automatic defrosting and evaporation
- 3-mt length coiled power cable with Schuko plug
- Main supply: 230V . 50 Hz single phase (60 Hz upon request)
- Total power 330W
- Heavy-Duty HDPE structural base to work as bumper
- 4 resilient swivel castors Ø mm 125, 2 with brake



Guide stampate
Costruite con un unico foglio di lamiera, facilitano la pulizia

Pressed runners
made with one single sheet layer for easy cleaning



Vano con angoli arrotondati
soddisfano il requisito igienico "H1"

Compartment with no-sharp edges
compliant with "H1" hygiene system

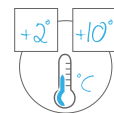

DETTAGLIO
DETAIL

Art. 3415-16GS.R

ARTICOLO / ARTICLE	PREZZO / PRICE	TIPOLOGIA / TYPOLOGY	GN	SUPPORTO / RUNNERS	PASSO / SPACING CM	POTENZA / POWER	MAX DIM. CM
3415-16GS.R	€ 6.446,00		16 GN 1/1		5.5	330W	55x78x166 h

OPTIONAL	PREZZO / PRICE		DESCRIZIONE / DESCRIPTION
MA	€ 126,00	-	Maniglia di chiusura con serratura Closure handle with lock

ACCESSORI / ACCESSORIES	PREZZO / PRICE		DESCRIZIONE / DESCRIPTION
A0170	€ 47,00	2	Griglia in filo inox 1/1 GN 1/1 GN stainless steel wire shelf

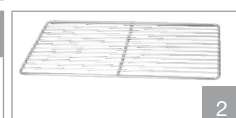

ARMADI PORTAVASSOI - PORTATEGLIE NEUTRI - COIBENTATI NEUTRAL/INSULATED TRAY/PAN MOBILE CUPBOARDS - SINGLE DOOR

- Struttura completamente saldata, realizzata in lamiera di acciaio inox AISI 304, finitura spazzolata, in parete singola oppure doppia coibentata con pannelli in poliuretano espanso posizionati fra le due pareti di lamiera (serie DP)
- Specifici per la veicolazione su camion
- 1 sportello frontale a battente, apribile a 270°, in doppia parete con guarnizione di tenuta in gomma
- Maniglia di apertura con chiusura a scatto, optional con serratura
- Coppia di maniglie di spinta posizionate su entrambi i lati, utilizzabili anche a sportelli aperti
- Vano interno predisposto con supporti per teglie, bacinelle, vassoi di differente conformazione a seconda del modello
- Termometro nella versione in doppia parete
- Paracolpi perimetrale in gomma grigia antitraccia
- Ruote ø cm 16, due fisse, due piroettanti con freno, supporto zincato, anello in gomma grigia antitraccia, rotolamento su cuscinetti

- Fully welded AISI 304 stainless steel sheet construction, brushed finish; single or double skin insulated with expanded polyurethane panels fitted between the steel sheet walls ("DP" range)
- Suitable for transport on trucks
- 1 Double skin front door with rubber seal, opening to 270°
- Snap closure handle (optional with lock)
- 2 Pushing bars on both sides that can be used even with open doors
- Internal compartment fitted with runners for pans and trays of different sizes depending on the model
- Thermometer in the double skin version
- All round grey non marking rubber bumper
- 2 Fixed and 2 braked swivel castors, ø 16 cm, with galvanized brackets; grey non marking rubber tread rolling on bearings



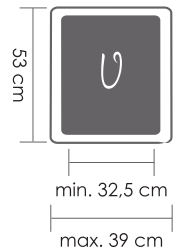
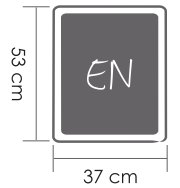
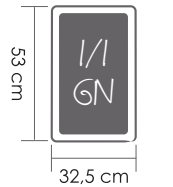

200 kg



ARTICOLO / ARTICLE	PREZZO / PRICE	PORT. VASSOI-TEGLIE / TRAY-CONTAINER CAP	SUPPORTO / RUNNERS	PASSO CM / SHELF SPACING	MAX DIM. CM
3208GN	€ 2.607,00	8 GN 1/1	L	12	78x73x151 h
3208EN	€ 2.564,00	8 EN		8	
3213GN	€ 2.684,00	13 GN 1/1		12	
3208U	€ 2.448,00	8 U	Universale / Universal	12	78x73x191 h
3212GN	€ 2.831,00	12 GN 1/1	L	12	
3212EN	€ 2.766,00	12 EN		8	
3218 GN	€ 2.922,00	18 GN 1/1	C	12	78x73x151 h
3212U	€ 2.547,00	12 U	Universale / Universal	12	
3208GN-DP	€ 3.076,00	8 GN 1/1	L	12	
3208EN-DP	€ 3.032,00	8 EN		8	
3213GN-DP	€ 3.150,00	13 GN 1/1		12	
3208U-DP	€ 2.915,00	8 U	Universale / Universal	12	78x73x191 h
3212GN-DP	€ 3.377,00	12 GN 1/1	L	12	
3212EN-DP	€ 3.312,00	12 EN		8	
3218GN-DP	€ 3.467,00	18 GN 1/1	C	12	78x73x191 h
3212U-DP	€ 3.093,00	12 U	Universale / Universal	12	

ARMADI PORTAVASSOI - PORTATEGLIE NEUTRI - COIBENTATI
 NEUTRAL/INSULATED TRAY/PAN MOBILE CUPBOARDS - SINGLE DOOR



OPTIONAL	PREZZO / PRICE		DESCRIZIONE / DESCRIPTION	PER / FOR	
E	€ 97,00	1	Set 4 ruote elastiche, di cui 2 con freno, per pavimenti sconnessi o per esterno Set with 4 resilient castors, 2 with brake, for uneven floors / outdoor use	Tutti gli articoli All Articles	
MA	€ 126,00	-	Maniglia di chiusura con serratura Closure handle with lock		
ACCESSORI / ACCESSORIES	PREZZO / PRICE		DESCRIZIONE / DESCRIPTION	PER / FOR	
A0170	€ 47,00	2	Griglia in filo inox 1/1 GN 1/1 GN stainless steel wire shelf	Tutti gli articoli All Articles	

ARMADI PORTAVASSOI - PORTATEGLIE CALDI HEATED TRAY/PAN MOBILE CUPBOARDS - SINGLE DOOR



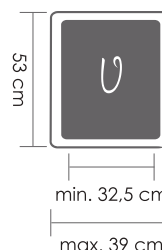
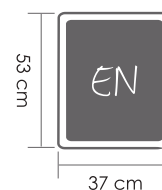
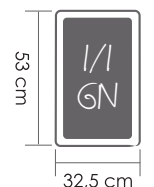
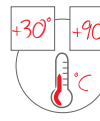

- Struttura completamente saldata, realizzata in lamiera di acciaio inox AISI 304, finitura spazzolata, coibentata con pannelli in poliuretano espanso posizionati fra le due pareti di lamiera
- Specifici per la veicolazione su camion
- 1 sportello frontale a battente, apribile a 270°, in doppia parete con guarnizione di tenuta in gomma
- Maniglia di apertura con chiusura a scatto, optional con serratura
- Coppia di maniglie di spinta posizionate su entrambi i lati, utilizzabili anche a sportelli aperti
- Vano interno predisposto con supporti per teglie, bacinelle, vassoi di differente conformazione a seconda del modello
- Termometro analogico
- Gruppo riscaldante ventilato composto da struttura in lamiera di acciaio inox AISI 304 con all'interno motoventilatore e resistenza, pannello comandi integrato, dotato di interruttore di accensione con spia luminosa, termostato, spia di segnalazione del funzionamento, sul retro cavo di alimentazione spiralato
- Il gruppo è asportabile per una facile manutenzione (l'armadio, privato delle parti elettriche, può essere lavato con lancia)
- Tensione rete 230 Volt monofase - 50/60Hz
- Possibilità di umidificare il vano interno tramite apposita vaschetta con acqua
- Paracolpi perimetrale in gomma grigia antitraccia
- Ruote ø cm 16, due fisse, due piroettanti con freno, supporto zincato, anello in gomma grigia antitraccia, rotolamento su cuscinetti

- Fully welded AISI 304 stainless steel sheet construction, brushed finish; double skin insulated with expanded polyurethane panels fitted between the steel sheet walls
- Suitable for transport on trucks
- 1 Double skin front door with rubber seal opening to 270°
- Snap closure handle (optional with lock)
- 2 Pushing bars on both sides that can be used even with open doors
- Internal compartment fitted with runners for containers, pans and trays of different sizes depending on the model
- Analog thermometer
- Ventilated heating unit consisting of an AISI 304 stainless steel sheet casing containing a powered fan and heating element, built-in control panel fitted with ON/OFF switch with warning light, thermostat, operation warning light and coiled power cable on the backside
- The heating unit can be pulled out for an easy maintenance (the cupboard can be washed with a water jet after removing the heating unit)
- Mains supply: 230V, 50 Hz (60 Hz upon request), single-phase
- Water container to release moisture inside the cupboard
- All round grey non marking rubber bumper
- 2 Fixed and 2 braked swivel castors, ø 16 cm, with galvanized brackets; grey non marking rubber tread rolling on bearings



ARTICOLO / ARTICLE	PREZZO / PRICE	PORT. VASSOI-TEGLIE / TRAY-CONTAINER CAP	SUPPORTO / RUNNERS	PASSO CM / SHELF SPACING	POTENZA / POWER	MAX DIM. CM
3208GN-K	€ 3.797,00	8 GN 1/1	L	12	1600W	78x73x151 h
3208EN-K	€ 3.754,00	8 EN				78x73x151 h
3213GN-K	€ 3.872,00	13 GN 1/1	C	8		78x73x151 h
3208U-K	€ 3.681,00	8 U	Universale / Universal	12		78x73x151 h
3212GN-K	€ 4.100,00	12 GN 1/1	L	12		78x73x191 h
3212EN-K	€ 4.034,00	12 EN				
3218GN-K	€ 4.190,00	18 GN 1/1	C	8		
3212U-K	€ 3.815,00	12 U	Universale / Universal	12		



OPTIONAL	PREZZO / PRICE		DESCRIZIONE / DESCRIPTION	PER / FOR	
E	€ 97,00	1	Set 4 ruote elastiche, di cui 2 con freno, per pavimenti sconnessi o per esterno <i>Set with 4 resilient castors, 2 with brake, for uneven floors / outdoor use</i>	Tutti gli articoli <i>All Articles</i>	 <div style="text-align: right;">1</div>
MA	€ 126,00	-	Maniglia di chiusura con serratura <i>Closure handle with lock</i>		
ACCESSORI / ACCESSORIES	PREZZO / PRICE		DESCRIZIONE / DESCRIPTION	PER / FOR	
A0170	€ 47,00	2	Griglia in filo inox 1/1 GN <i>1/1 GN stainless steel wire shelf</i>	Tutti gli articoli <i>All Articles</i>	 <div style="text-align: right;">2</div>

ARMADI PORTAVASSOI - PORTATEGLIE NEUTRI - COIBENTATI NEUTRAL/INSULATED TRAY/PAN MOBILE CUPBOARDS - DOUBLE DOOR

- Struttura completamente saldata, realizzata in lamiera di acciaio inox AISI 304, finitura spazzolata, in parete singola oppure doppia coibentata con pannelli in poliuretano espanso posizionati fra le due pareti di lamiera (serie DP)
- Specifici per la veicolazione su camion
- 2 sportelli frontali a battente, apribili a 270°, in doppia parete con guarnizione di tenuta in gomma
- Maniglie di apertura con chiusura a scatto, optional con serratura
- Coppia di maniglie di spinta posizionate su entrambi i lati, utilizzabili anche a sportelli aperti
- Vano interno predisposto con supporti per teglie, bacinelle, vassoi di differente conformazione a seconda del modello
- Termometro nella versione in doppia parete
- Paracolpi perimetrale in gomma grigia antitraccia
- Ruote ø cm 16, due fisse, due piroettanti con freno, supporto zincato, anello in gomma grigia antitraccia, rotolamento su cuscinetti

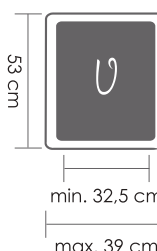
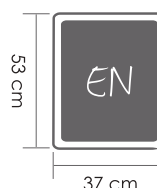
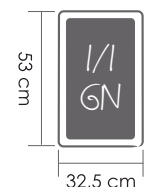

- Fully welded AISI 304 stainless steel sheet construction, brushed finish; single skin, or double skin insulated with expanded polyurethane panels fitted between the steel sheet walls ("DP" range)
- Suitable for transport on trucks
- 2 Double skin front doors with rubber seal, opening to 270°
- Snap closure handles (optional with lock)
- 2 Pushing bars on both sides that can be used even with open doors
- Internal compartment fitted with runners for containers pans and trays of different sizes depending on the model
- Thermometer in the double skin version
- All round grey non marking rubber bumper
- 2 Fixed and 2 braked swivel castors, ø 16 cm, with galvanized brackets; grey non marking rubber tread rolling on bearings



ARTICOLO / ARTICLE	PREZZO / PRICE	PORT. VASSOI-TEGLIE / TRAY-CONTAINER CAP	SUPPORTO / RUNNERS	PASSO CM / SHELF SPACING	MAX DIM. CM
3216GN	€ 3.795,00	8x2 GN 1/1	L	12	131x73x151 h
3216EN	€ 3.706,00	8x2 EN		8	
3226GN	€ 3.945,00	13x2 GN 1/1		12	
3216U	€ 3.472,00	8x2 U	Universale / Universal	12	131x73x191 h
3224GN	€ 4.315,00	12x2 GN 1/1	L	12	
3224EN	€ 4.182,00	12x2 EN		8	
3236GN	€ 4.493,00	18x2 GN 1/1	C	12	131x73x151 h
3224U	€ 3.746,00	12x2 U	Universale / Universal	8	
3216GN-DP	€ 4.017,00	8x2 GN 1/1	L	12	
3216EN-DP	€ 3.931,00	8x2 EN		12	
3226GN-DP	€ 4.764,00	13x2 GN 1/1	C	8	131x73x191 h
3216U-DP	€ 3.695,00	8x2 U	Universale / Universal	12	
3224GN-DP	€ 5.204,00	12x2 GN 1/1	L	12	
3224EN-DP	€ 5.072,00	12x2 EN		8	
3236GN-DP	€ 5.383,00	18x2 GN 1/1	C	12	131x73x191 h
3224U-DP	€ 4.634,00	12x2 U	Universale / Universal	8	

ARMADI PORTAVASSOI - PORTATEGLIE NEUTRI - COIBENTATI
 NEUTRAL/INSULATED TRAY/PAN MOBILE CUPBOARDS - DOUBLE DOOR



OPTIONAL	PREZZO / PRICE		DESCRIZIONE / DESCRIPTION	PER / FOR	
E	€ 97,00	1	Set 4 ruote elastiche, di cui 2 con freno, per pavimenti sconnessi o per esterno Set with 4 resilient castors, 2 with brake, for uneven floors / outdoor use	Tutti gli articoli All Articles	
MA	€ 126,00	-	Maniglia di chiusura con serratura Closure handle with lock		
ACCESSORI / ACCESSORIES	PREZZO / PRICE		DESCRIZIONE / DESCRIPTION	PER / FOR	
A0170	€ 47,00	2	Griglia in filo inox 1/1 GN 1/1 GN stainless steel wire shelf	Tutti gli articoli All Articles	

ARMADI PORTAVASSOI - PORTATEGLIE CALDI HEATED TRAY/PAN MOBILE CUPBOARDS - DOUBLE DOOR



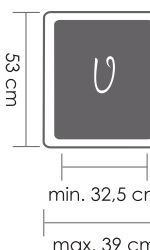
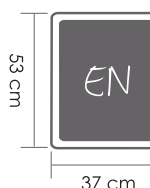
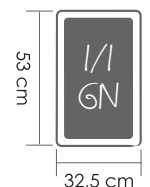
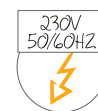
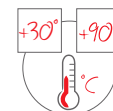

- Struttura completamente saldata, realizzata in lamiera di acciaio inox AISI 304, finitura spazzolata, coibentata con pannelli in poliuretano espanso posizionati fra le due pareti di lamiera
- Specifici per la veicolazione su camion
- 2 sportelli frontali a battente, apribili a 270°, in doppia parete con guarnizione di tenuta in gomma
- Maniglie di apertura con chiusura a scatto, optional con serratura
- Coppia di maniglie di spinta posizionate su entrambi i lati, utilizzabili anche a sportelli aperti
- Vano interno predisposto con supporti per teglie, bacinelle, vassoi di differente conformazione a seconda del modello
- Termometro analogico
- Gruppo riscaldante ventilato composto da struttura in lamiera di acciaio inox AISI 304 con all'interno motoventilatore e resistenza, pannello comandi integrato, dotato di interruttore di accensione con spia luminosa, termostato, spia di segnalazione del funzionamento, sul retro cavo di alimentazione spiralato
- Il gruppo è asportabile per una facile manutenzione (l'armadio, privato delle parti elettriche, può essere lavato con lancia)
- Tensione rete 230 Volt monofase - 50/60Hz
- Possibilità di umidificare il vano interno tramite apposita vaschetta con acqua
- Paracolpi perimetrale in gomma grigia antitraccia
- Ruote ø cm 16, due fisse, due piroettanti con freno, supporto zincato, anello in gomma grigia antitraccia, rotolamento su cuscinetti

- Fully welded AISI 304 stainless steel sheet construction, brushed finish; double skin insulated with expanded polyurethane panels fitted between the steel sheet walls
- Suitable for transport on trucks
- 2 Double skin front doors with rubber seal opening to 270°
- Snap closure handles (optional with lock)
- 2 Pushing bars on both sides that can be used even with open doors
- Internal compartment fitted with runners for containers, pans and trays of different sizes depending on the model
- Analog thermometer
- Ventilated heating unit consisting of an AISI 304 stainless steel sheet casing containing a powered fan and heating element, built-in control panel fitted with ON/OFF switch with warning light, thermostat, operation warning light and coiled power cable on the back
- The heating unit can be pulled out for ease of maintenance (the cupboard can be washed with a water jet after removing the heating unit)
- Mains supply: 230V, 50 Hz (60 Hz upon request), single-phase
- Water container to release moisture inside the cupboard
- All round grey non marking rubber bumper
- 2 Fixed and 2 braked swivel castors, ø 16 cm, with galvanized brackets; grey non marking rubber tread rolling on bearings



ARTICOLO / ARTICLE	PREZZO / PRICE	PORT. VASSOI-TEGLIE / TRAY-CONTAINER CAP	SUPPORTO / RUNNERS	PASSO CM / SHELF SPACING	POTENZA / POWER	MAX DIM. CM
3216GN-K	€ 5.413,00	8x2 GN 1/1	L	12	3200W	131x73x151 h
3216EN-K	€ 5.324,00	8x2 EN				
3226GN-K	€ 6.159,00	13x2 GN 1/1	C	8		
3216U-K	€ 5.091,00	8x2 U	Universale / Universal	12		
3224GN-K	€ 6.600,00	12x2 GN 1/1	L	12		131x73x191 h
3224EN-K	€ 6.467,00	12x2 EN				
3236GN-K	€ 6.777,00	18x2 GN 1/1	C	8		
3224U-K	€ 6.029,00	12x2 U	Universale / Universal	12		



OPTIONAL	PREZZO / PRICE		DESCRIZIONE / DESCRIPTION	PER / FOR	
E	€ 97,00	1	Set 4 ruote elastiche, di cui 2 con freno, per pavimenti sconnessi o per esterno <i>Set with 4 resilient castors, 2 with brake, for uneven floors / outdoor use</i>	Tutti gli articoli <i>All Articles</i>	
MA	€ 126,00	-	Maniglia di chiusura con serratura <i>Closure handle with lock</i>		
ACCESSORI / ACCESSORIES	PREZZO / PRICE		DESCRIZIONE / DESCRIPTION	PER / FOR	
A0170	€ 47,00	2	Griglia in filo inox 1/1 GN <i>1/1 GN stainless steel wire shelf</i>	Tutti gli articoli <i>All Articles</i>	

ARMADI PORTAVASSOI - PORTATEGLIE NEUTRI - COIBENTATI
NEUTRAL/INSULATED TRAY/PAN MOBILE CUPBOARDS - SINGLE DOOR

- Struttura completamente saldata, realizzata in lamiera di acciaio inox AISI 304, finitura spazzolata, in parete singola oppure doppia coibentata con pannelli in poliuretano espanso posizionati fra le due pareti di lamiera (serie DP)
- Specifici per la veicolazione su camion
- 1 sportello frontale a battente, apribile a 270°, in doppia parete con guarnizione di tenuta in gomma
- Maniglia di apertura con chiusura a scatto, optional con serratura
- Coppia di maniglie di spinta posizionate su entrambi i lati, utilizzabili anche a sportelli aperti
- Vano interno predisposto con supporti per teglie, bacinelle, vassoi di differente conformazione a seconda del modello
- Termometro nella versione in doppia parete
- Paracolpi perimetrale in gomma grigia antitraccia
- Ruote ø cm 16, due fisse, due piroettanti con freno, supporto zincato, anello in gomma grigia antitraccia, rotolamento su cuscinetti



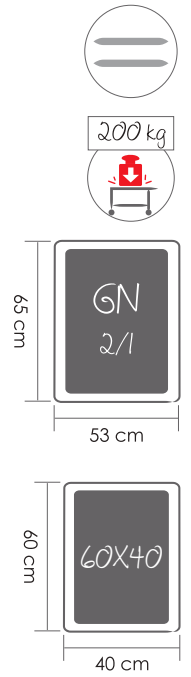

- *Fully welded AISI 304 stainless steel sheet construction, brushed finish; single or double skin insulated with expanded polyurethane panels fitted between the steel sheet walls ("DP" range)*
- *Suitable for transport on trucks*
- *1 Double skin front door opening to 270° with rubber seal*
- *Snap closure handle (optional with lock)*
- *2 Pushing bars on both sides that can be used even with open doors*
- *Internal compartment fitted with runners for containers, pans and trays of different shapes depending on the model*
- *Thermometer in the double skin version*
- *All round grey non marking rubber bumper*
- *2 Fixed and 2 braked swivel castors, ø 16 cm, with galvanized brackets; grey non marking rubber tread rolling on bearings*



ARTICOLO / ARTICLE	PREZZO / PRICE	PORT. VASSOI-TEGLIE / TRAY-CONTAINER CAP	SUPPORTO / RUNNERS	PASSO CM / SHELF SPACING	MAX DIM. CM
3213-6040	€ 2.951,00	13 - 60x40 cm	L		93x88x151 h
3213-2GN	€ 2.968,00	13 GN 2/1	C		93x88x191 h
3218-6040	€ 3.240,00	18 - 60x40 cm	L		93x88x151 h
3218-2GN	€ 3.256,00	18 GN 2/1	C		93x88x191 h
3213-6040-DP	€ 3.464,00	13 - 60x40 cm	L		93x88x151 h
3213-2GN-DP	€ 3.481,00	13 GN 2/1	C		93x88x191 h
3218-6040-DP	€ 3.860,00	18 - 60x40 cm	L		93x88x191 h
3218-2GN-DP	€ 3.877,00	18 GN 2/1	C		93x88x191 h

ARMADI PORTAVASSOI - PORTATEGLIE NEUTRI - COIBENTATI
 NEUTRAL/INSULATED TRAY/PAN MOBILE CUPBOARDS - SINGLE DOOR



OPTIONAL	PREZZO / PRICE		DESCRIZIONE / DESCRIPTION	PER / FOR	
E	€ 97,00	1	Set 4 ruote elastiche, di cui 2 con freno, per pavimenti sconnessi o per esterno Set with 4 resilient castors, 2 with brake, for uneven floors / outdoor use	Tutti gli articoli All Articles	
MA	€ 126,00	-	Maniglia di chiusura con serratura Closure handle with lock		
ACCESSORI / ACCESSORIES	PREZZO / PRICE		DESCRIZIONE / DESCRIPTION	PER / FOR	
A0171	€ 76,00	2	Griglia in filo inox 2/1 GN 2/1 GN stainless steel wire shelf	Tutti gli articoli All Articles	

ARMADI PORTAVASSOI - PORTATEGLIE CALDI HEATED TRAY/PAN MOBILE CUPBOARDS - SINGLE DOOR

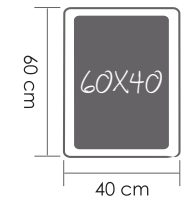
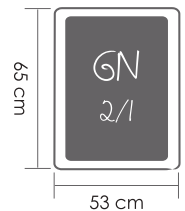
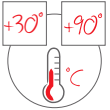

- Struttura completamente saldata, realizzata in lamiera di acciaio inox AISI 304, finitura spazzolata, coibentata con pannelli in poliuretano espanso posizionati fra le due pareti di lamiera
- Specifici per la veicolazione su camion
- 1 sportello frontale a battente, apribile a 270°, in doppia parete con guarnizione di tenuta in gomma
- Maniglia di apertura con chiusura a scatto, optional con serratura
- Coppia di maniglie di spinta posizionate su entrambi i lati, utilizzabili anche a sportelli aperti
- Vano interno predisposto con supporti per teglie, bacinelle, vassoi di differente conformazione a seconda del modello
- Termometro analogico
- Gruppo riscaldante ventilato composto da struttura in lamiera di acciaio inox AISI 304 con all'interno motoventilatore e resistenza, pannello comandi integrato, dotato di interruttore di accensione con spia luminosa, termostato, spia di segnalazione del funzionamento, sul retro cavo di alimentazione spiralato
- Il gruppo è asportabile per una facile manutenzione (l'armadio, privato delle parti elettriche, può essere lavato con lancia)
- Tensione rete 230 Volt monofase - 50/60Hz
- Possibilità di umidificare il vano interno tramite apposita vaschetta con acqua
- Paracolpi perimetrale in gomma grigia antiraccia
- Ruote ø cm 16, due fisse, due piroettanti con freno, supporto zincato, anello in gomma grigia antiraccia, rotolamento su cuscinetti

- Fully welded AISI 304 stainless steel sheet construction, brushed finish; double skin insulated with expanded polyurethane panels fitted between the steel sheet walls
- Suitable for transport on trucks
- 1 Double skin front door opening to 270° with rubber seal
- Snap closure handles (optional with lock)
- 2 Pushing bars on both sides that can be used even with open doors
- Internal compartment fitted with runners for containers, pans and trays of different sizes depending on model
- Analog thermometer
- Ventilated heating unit consisting of an AISI 304 stainless steel sheet casing containing a powered fan and heating element, built-in control panel fitted with ON/OFF switch with warning light, thermostat, operation warning light and coiled power cable on the back
- The heating unit can be pulled out for ease of maintenance (the cupboard can be washed with a water jet after removing the heating unit)
- Mains supply: 230V, 50 Hz (60 Hz upon request), single-phase
- Water container to release moisture inside the cupboard
- All round grey non marking rubber bumper
- 2 Fixed and 2 braked swivel castors, ø 16cm, with galvanized brackets; grey non marking rubber tread rolling on bearings



ARTICOLO / ARTICLE	PREZZO / PRICE	PORT. VASSOI-TEGLIE / TRAY-CONTAINER CAP	SUPPORTO / RUNNERS	PASSO CM / SHELF SPACING	POTENZA / POWER	MAX DIM. CM
3213-6040-K	€ 4.176,00	13 - 60x40 cm	L		1600W	93x88x151 h
3213-2GN-K	€ 4.192,00	13 GN 2/1	C			93x88x191 h
3218-6040-K	€ 4.573,00	18 - 60x40 cm	L			93x88x191 h
3218-2GN-K	€ 4.587,00	18 GN 2/1	C			93x88x191 h

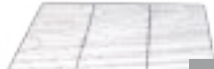

OPTIONAL	PREZZO / PRICE		DESCRIZIONE / DESCRIPTION	PER / FOR	
E	€ 97,00	1	Set 4 ruote elastiche, di cui 2 con freno, per pavimenti sconnessi o per esterno <i>Set with 4 resilient castors, 2 with brake, for uneven floors / outdoor use</i>	Tutti gli articoli <i>All Articles</i>	
MA	€ 126,00	-	Maniglia di chiusura con serratura <i>Closure handle with lock</i>		
ACCESSORI / ACCESSORIES	PREZZO / PRICE		DESCRIZIONE / DESCRIPTION	PER / FOR	
A0171	€ 76,00	2	Griglia in filo inox 2/1 GN <i>2/1 GN stainless steel wire shelf</i>	Tutti gli articoli <i>All Articles</i>	

ARMADIO RIGENERATORE PORTATEGLIE GN CONTAINER REGENERATING CABINET

- Gestione di cicli di rigenerazione differenziati in base alla tipologia di cibo
- Struttura in lamiera di acciaio inox AISI 304, finitura spazzolata
- Costruzione in doppia parete
- Coibentato con pannelli in poliuretano espanso e lana di vetro
- 2 sportelli frontali a battente, apribile a 180°
- Guarnizione vano estraibile senza l'ausilio di attrezzi
- Vano interno con angoli arrotondati (soddisfa il requisito igienico H1) predisposto per teglie GN 2/1 e sottomultipli
- 2 coppie paratie portateglie estraibili con guide a "C", con capienza massima di 16 teglie GN 2/1 o 32 teglie GN 1/1
- Pannello comandi elettronico dotato di display LCD per controllo temperatura, tempo e umidità
- Temperatura di esercizio 30÷150°C
- Riscaldamento tramite gruppo ventilato con 3 motoventilatori e 3 resistenze con potenza da 2000W a 3000W cadauna a seconda dell'applicazione
- Termostato di sicurezza con sonda in camera
- Sfiato evacuazione umidità in eccesso manuale
- Tensione rete 400V trifase 50Hz
- Spina trifase a 5 poli
- Base di rinforzo in HDPE nero con funzione di paracolpo
- Ruote piroettanti Ø mm 160, di cui 2 con freno

- Management of differentiated regeneration cycles according to the type of food
- AISI 304 stainless steel sheet construction, brushed finish
- Double wall construction
- Polyurethane foam and fiberglass insulation panels
- 2 front hinged doors, opening to 180°
- Compartment seal removable without the use of tools
- Interior compartment with no-sharp edges (compliant with H1 hygiene standard) suitable for containers 2/1 GN (or submultiples)
- 2 pairs of "C"-shaped runners with a maximum capacity of 16 GN 2/1 trays or 32 GN 1/1 trays
- Electronic control panel equipped with LCD display for controlling temperature, time and humidity
- Operating temperature 30÷150°C
- Heating by means of ventilated unit with 3 motorized fans and 3 heating elements from 2000W to 3000W each, according to how it will be used
- Safety thermostat with in-room probe
- Manual excess humidity evacuation vent
- Mains supply 400V three-phase 50Hz
- Three-phase 5 poles plug
- Black HDPE reinforced base with bumper function
- 4 swivel castors Ø mm 160, 2 with brake

**NOVITÀ
NEW**



Vano con angoli arrotondati
soddisfano il requisito
igienico "H1"

Compartment with no-sharp
edges
compliant with "H1" hygiene
system



+30° +150°





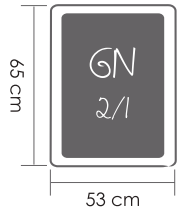





vent.



ARTICOLO / ARTICLE	PREZZO / PRICE	PORT. TEGLIE / CONTAINER CAP	MAX DIM. CM
AR2116	in base alle specifiche richieste / based on requirements	16 GN 2/1	87x99x181 h





	CARRELLI COLAZIONE <i>BREAKFAST TROLLEYS</i>	PAG. 104
	ELEMENTI PER LA DISTRIBUZIONE DEI PASTI <i>MEAL DISTRIBUTION UNITS</i>	PAG. 106
	LINEA SELF SERVICE E NASTRI TRASPORTATORI <i>SELF SERVICE LINES AND CONVEYOR BELTS</i>	PAG. 108
	SOLLEVATORI VASSOI <i>TRAY DISPENSERS</i>	PAG. 116
	SOLLEVATORI PIATTI <i>PLATE LOWERATORS</i>	PAG. 117
	SOLLEVATORI CESTI <i>RACK LOWERATORS</i>	PAG. 118
	CARRELLI TERMICI A GIORNO <i>BAIN-MARIE TROLLEYS</i>	PAG. 121
	CARRELLI REFRIGERATI <i>REFRIGERATED TROLLEYS</i>	PAG. 122
	ARMADI PORTATEGLIE CALDI E REFRIGERATI <i>HEATED AND REFRIGERATED PAN MOBILE CUPBOARDS</i>	PAG. 123

CARRELLO PER PRIME COLAZIONI per distribuzione con vassoi GN 1/1
BREAKFAST TROLLEY for food distribution with 1/1 GN trays

- Struttura in acciaio inox AISI 304, finitura spazzolata
- 2 vani con 8 coppie di guide a "C" passo cm 8 per l'inserimento di vassoi/contenitori 1/1 GN
- Sportelli frontali a battente, apribili a 270° con magneti di bloccaggio a porta aperta
- Maniglia di apertura con chiusura a scatto, optional con serratura
- Maniglie di spinta su due lati
- Ringhierino posteriore di contenimento sul piano superiore
- Paracolpi perimetrale in gomma grigia
- Ruote ø cm 12,5, 2 fisse, 2 piroettanti con freno, in gomma grigia antitraccia

- *AISI 304 stainless steel structure, brushed finish*
- *2 compartments with 8 pairs of "C"-shaped runners, 8 cm runner-spacing, for 1/1 GN trays and pans*
- *270° opening front hinged doors with magnets (to keep the doors open)*
- *Snap closure handle, optional with lock*
- *Pushing handles on 2 sides*
- *Back rail on the top shelf*
- *Grey rubber all-round bumper*
- *Non-marking rubber swivel castors, ø cm 12.5, 2 with brake*



Guide a "C"
"C-shaped" runners



Art. 7450

ARTICOLO / ARTICLE	PREZZO / PRICE	VANO SX / LEFT COMP	VANO DX / RIGHT COMP	MAX DIM. CM
7450	€ 3.171,00	8 coppie di guide passo 8 cm per l'inserimento di vassoi/contenitori 1/1 GN 8 pairs of "C"-shaped runners, 8 cm runner-spacing, for 1/1 GN trays and pans	8 coppie di guide passo 8 cm per l'inserimento di vassoi/contenitori 1/1 GN 8 pairs of "C"-shaped runners, 8 cm runner-spacing, for 1/1 GN trays and pans	104x76x99 h

OPTIONAL	PREZZO / PRICE	DESCRIZIONE / DESCRIPTION
MA	€ 126,00	Maniglia di chiusura con serratura Closure handle with lock

ACCESSORI / ACCESSORIES	PREZZO / PRICE	DESCRIZIONE / DESCRIPTION
A050M	€ 324,00	1 Mensola portavassoi removibile Removable tray shelf
A050R	€ 324,00	2 Raccogliocce da posizionare sul piano superiore Drip tray to be placed on the upper shelf

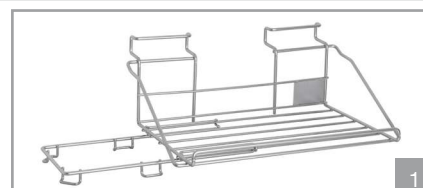

CARRELLO PER PRIME COLAZIONI per distribuzione in multiporzione BREAKFAST TROLLEY for multi-service distribution

- Struttura in acciaio inox AISI 304, finitura spazzolata
- Vano lato sinistro: 5 coppie di guide a "L" passo cm 12 per l'inserimento di cesti per lavastoviglie cm 50x50
- Vano lato destro: 8 coppie di guide a "C" passo cm 8 per l'inserimento di vassoi/contenitori 1/1 GN
- Sportelli frontali a battente, apribili a 270° con magneti di bloccaggio a porta aperta
- Maniglia di apertura con chiusura a scatto, optional con serratura
- Maniglie di spinta su due lati
- Ringhiero posteriore di contenimento sul piano superiore
- Paracolpi perimetrale in gomma grigia
- Ruote ø cm 12,5, 2 fisse, 2 piroettanti con freno, in gomma grigia antitraccia

- *AISI 304 stainless steel structure, brushed finish*
- *Left compartment : 5 pairs of "L"-shaped runners, 12 cm runner-spacing, for 50x50 cm dishwashing racks*
- *Right compartment : 8 pairs of "C"-shaped runners, 8 cm runner-spacing, for 1/1 GN trays and pans*
- *270° opening front hinged doors with magnets (to keep the doors open)*
- *Snap closure handle, optional with lock*
- *Pushing handles on 2 sides*
- *Back rail on the top shelf*
- *Grey rubber all-round bumper*
- *Non-marking rubber swivel castors, ø cm 12.5, 2 with brake*



*personalizzabile
customizable*

Stampa digitale resistente all'acqua e ai raggi UV, personalizzata a piacere
NB: file da voi fornito.

Preventivo a richiesta

*Customizable water-proof UV-resistant digital print
Please note: the file containing the image should be provided by you
Quotes upon request*



Art. 7460



ARTICOLO / ARTICLE	PREZZO / PRICE	VANO SX / LEFT COMP	VANO DX / RIGHT COMP	MAX DIM. CM
7460	€ 3.318,00	5 coppie di guide passo 12 cm per l'inserimento di cesti per lavastoviglie 50x50 cm <i>5 pairs of "L"-shaped runners, 12 cm runner-spacing, for 50x50 cm dishwashing racks</i>	8 coppie di guide passo 8 cm per l'inserimento di vassoi/contenitori 1/1 GN <i>8 pairs of "C"-shaped runners, 8 cm runner-spacing, for 1/1 GN trays and pans</i>	125x76x99 h

OPTIONAL	PREZZO / PRICE	DESCRIZIONE / DESCRIPTION
MA	€ 126,00	Maniglia di chiusura con serratura <i>Closure handle with lock</i>



ACCESSORI / ACCESSORIES	PREZZO / PRICE	DESCRIZIONE / DESCRIPTION
A050C	€ 206,00	1 Bacinella raccogliocce in acciaio inox da posizionare alla base del vano sinistro <i>Stainless steel drip tray to be placed at the bottom of the left compartment</i>
A050M	€ 324,00	2 Mensola portavassoi removibile <i>Removable tray shelf</i>
A051R	€ 324,00	3 Raccogliocce da posizionare sul piano superiore <i>Drip tray to be placed on the upper shelf</i>

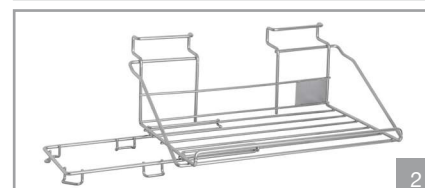

ELEMENTI BAGNOMARIA, REFRIGERATI E NEUTRI PER LA DISTRIBUZIONE DEI PASTI BAIN-MARIE, REFRIGERATED AND NEUTRAL GN UNITS FOR MEAL DISTRIBUTION

NEUTRO

- Struttura armadiata in lamiera di acciaio inox AISI 304, finitura spazzolata
- Parafiato in vetro con servizio standard o con apertura servi-piatti bambini (a seconda del modello)
- Ribaltina scorrevassoio in tubo
- Ripiano liscio
- Per il servizio "CASSA" versione senza parafiato con scorrevassoio compreso
- Piedini di appoggio regolabili, optional ruote piroettanti, 2 con freno

FREDDO

- Struttura armadiata in lamiera di acciaio inox AISI 304, finitura spazzolata
- Parafiato in vetro con servizio standard o con apertura servi-piatti bambini (a seconda del modello)
- Ribaltina scorrevassoio in tubo
- Refrigerazione statica +4°C +10°C
- Vasca in acciaio inox AISI 304 per bacinelle GN fino a cm 20 h (escluse)
- Foro sul fondo della vasca chiuso da rubinetto di scarico per lo scarico della condensa
- Pannello comandi con termostato-termometro digitale e interruttori di accensione con spia luminosa
- Tensione rete 230Volt monofase 50Hz, 60Hz a richiesta
- Sulla base, lato operatore, ripiani di servizio e pannello comandi
- Piedini di appoggio regolabili, optional ruote piroettanti, 2 con freno

CALDO

- Struttura armadiata in lamiera di acciaio inox AISI 304, finitura spazzolata
- Parafiato in vetro con servizio standard o con apertura servi-piatti bambini (a seconda del modello)
- Ribaltina scorrevassoio in tubo
- Vasca in acciaio inox AISI 304 per bacinelle GN fino a cm 20 h (escluse)
- Riscaldamento a umido-bagnomaria, con resistenza esterna alla vasca
- Riscaldamento a secco: caratteristiche e costo a richiesta
- Foro sul fondo della vasca chiuso da rubinetto di scarico
- Pannello comandi con termostato-termometro digitale e interruttori di accensione con spia luminosa
- Tensione rete 230Volt monofase 50/60Hz
- Sulla base, lato operatore, ripiani di servizio e pannello comandi
- Piedini di appoggio regolabili, optional ruote piroettanti, 2 con freno

NEUTRAL

- AISI 304 stainless steel sheet cupboard structure, brushed finish
- Glass sneeze guard with standard or "kid-service" opening (depending on the model)
- Stainless steel rodde tray slide
- Flat shelf
- For "COUNTER" service version without sneeze guard, with tray slide
- Adjustable feet, optional swivel castors, 2 with brake

REFRIGERATED

- AISI 304 stainless steel sheet cupboard structure, brushed finish
- Glass sneeze guard with standard or "kid-service" opening (depending on the model)
- Stainless steel rodde tray slide
- Static refrigeration +4°C +10°C
- AISI 304 stainless steel well for up to 20 cm-deep GN pans (not included)
- Hole at the bottom of the well with tap
- Control panel with digital thermostat-thermometer and ON/OFF switch with warning light
- Mains supply 230V, single-phase, 50Hz (60Hz upon request)
- Shelves and control panel at the base of the trolley on operator side
- Adjustable feet, optional swivel castors, 2 with brake

HEATED

- AISI 304 stainless steel sheet cupboard structure, brushed finish
- Glass sneeze guard with standard or "kid-service" opening (depending on the model)
- Stainless steel rodde tray slide
- AISI 304 stainless steel well for up to 20 cm-deep GN pans (not included)
- Bain-marie heating with heating element outside the well
- Dry heating: details and quotes upon request
- Hole at the bottom of the well with drain tap
- Control panel with digital thermostat-thermometer and ON/OFF switch with warning light
- Mains supply 230V, single-phase, 50/60Hz
- Shelves and control panel at the base of the trolley on operator side
- Adjustable feet, optional swivel castors, 2 with brake

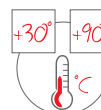
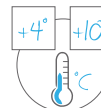

Optional bacinelle vedi pag. 78-79
Optional Gastronorms: see pp. 78-79





Art. 6704FH-RM+bacinelle / pans



Art. 6704F+bacinelle / pans

ELEMENTI BAGNOMARIA, REFRIGERATI E NEUTRI PER LA DISTRIBUZIONE DEI PASTI
BAIN-MARIE, REFRIGERATED AND NEUTRAL GN UNITS FOR MEAL DISTRIBUTION

VERSIONE CON PARAFIATO STANDARD STANDARD SNEEZE GUARD VERSION

ARTICOLO / ARTICLE	PREZZO / PRICE	TIPOLOGIA / TYPOLOGY	GN	POTENZA / POWER	MAX DIM. CM
6702N	€ 2.639,00		2x1/1	-	82x94x120 h
6703N	€ 2.806,00		3x1/1		120x94x120 h
6704N	€ 3.139,00		4x1/1		158x94x120 h
6702F	€ 4.852,00		2x1/1	361W	82x94x120 h
6703F	€ 5.169,00		3x1/1	416W	120x94x120 h
6704F	€ 5.787,00		4x1/1	543W	158x94x120 h
6702C	€ 3.633,00		2x1/1	1200W	82x94x120 h
6703C	€ 4.255,00		3x1/1	1500W	120x94x120 h
6704C	€ 4.877,00		4x1/1	2400W	158x94x120 h

VERSIONE CON PARAFIATO SERVI-PIATTI BAMBINI "KID-SERVICE" OPENING SNEEZE GUARD VERSION

ARTICOLO / ARTICLE	PREZZO / PRICE	TIPOLOGIA / TYPOLOGY	GN	DESCRIZIONE / DESCRIPTION	POTENZA / POWER	MAX DIM. CM
6702NH	€ 2.700,00		2x1/1	Parafiato in vetro con apertura "servi-piatti bambini"	-	82x94x133 h
6703NH	€ 2.867,00		3x1/1			120x94x133 h
6704NH	€ 3.199,00		4x1/1			158x94x133 h
6702FH	€ 4.913,00		2x1/1	Glass sneeze guard with "kid-service opening"	361W	82x94x133 h
6703FH	€ 5.229,00		3x1/1		416W	120x94x133 h
6704FH	€ 5.849,00		4x1/1		543W	158x94x133 h
6702CH	€ 3.693,00		2x1/1		1200W	82x94x133 h
6703CH	€ 4.315,00		3x1/1		1500W	120x94x133 h
6704CH	€ 4.936,00		4x1/1		2400W	158x94x133 h



Art. 6703N-P-RM

VERSIONE SENZA PARAFIATO NO SNEEZE GUARD VERSION

ARTICOLO / ARTICLE	PREZZO / PRICE	TIPOLOGIA / TYPOLOGY	GN	MAX DIM. CM
6702N-P	€ 2.083,00		2x1/1	82x94x83 h
6703N-P	€ 2.222,00		3x1/1	120x94x83 h
6704N-P	€ 2.479,00		4x1/1	158x94x83 h

OPTIONAL E ACCESSORI PER TUTTE LE VERSIONI CON E SENZA PARAFIATO

OPTIONAL ITEMS AND ACCESSORIES SUITABLE FOR ALL VERSIONS BOTH WITH AND WITHOUT SNEEZE GUARD

OPTIONAL	PREZZO / PRICE		DESCRIZIONE / DESCRIPTION	PER / FOR
RM	€ 64,00	1	Set 4 ruote piroettanti ø 12,5 cm, di cui 2 con freno (in sostituzione ai piedini) e maniglia di spinta Set with 4 swivel castors ø 12.5 cm, 2 with brake (as alternative to the feet) and pushing handle	Tutti gli articoli All Articles
A10	€ 39,00	2	Griglia liscia 1/1 GN / 1/1 GN Flat	Tutti gli articoli All Articles
A20	€ 46,00	3	Griglia asolata 1/1 GN / 1/1 GN Perforated	

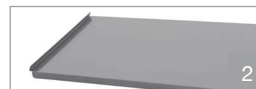

LINEA SELF SERVICE SELF SERVICE LINE

La linea Self Service è destinata all'esposizione e alla distribuzione pasti in realtà come mense, ospedali, università, aeroporti, autogrill e strutture ricettive in genere. La caratteristica più importante è rappresentata dalla modularità, che permette massima libertà nella combinazione dei vari elementi di cui è composta la linea per permettere al cliente di costruire la soluzione più congeniale per le proprie esigenze.

La struttura interamente realizzata in acciaio inox AISI 304 si compone di:

- Elementi per il mantenimento di alimenti caldi quali vasche bagnomaria o piani in vetroceramica con possibilità di vani inferiori riscaldati dotati di guide portateglie GN 1/1;
- Elementi per il mantenimento di alimenti freddi quali vasche a raffreddamento statico con possibilità di vani inferiori a raffreddamento ventilato dotati di guide portateglie GN 1/1;
- Elementi neutri con possibilità di inserimento sollevatori piatti e/o vassoi;
- Elementi neutri angolari concavi o convessi per garantire la massima adattabilità agli spazi.

The Self Service line is designed for displaying and distributing meals in canteens, hospitals, universities, airports, service areas and accommodation facilities in general. Modularity is the most important feature allowing the customer to combine the various elements the line is composed of to build the most suitable solution.

The structure is entirely made of AISI 304 stainless steel and consists of:

- *Elements for keeping food hot, like bain-marie wells or ceramic glass tops with the possibility of having heated lower compartments, equipped with GN 1/1 tray runners;*
- *Elements for keeping food cold, like static cooling wells, with the possibility of having lower compartments with ventilated cooling, equipped with GN 1/1 tray runners;*
- *Neutral elements that can accommodate plates and/or trays dispensers;*
- *Neutral concave or convex corner to ensure maximum adaptability to spaces.*

**NOVITÀ
NEW**

*personalizzabile
customizable*

Stampa digitale resistente all'acqua e ai raggi UV, personalizzata a piacere
NB: file da voi fornito.

Preventivo a richiesta

Customizable water-proof UV-resistant digital print

Please note: the file containing the image should be provided by you

Quotes upon request

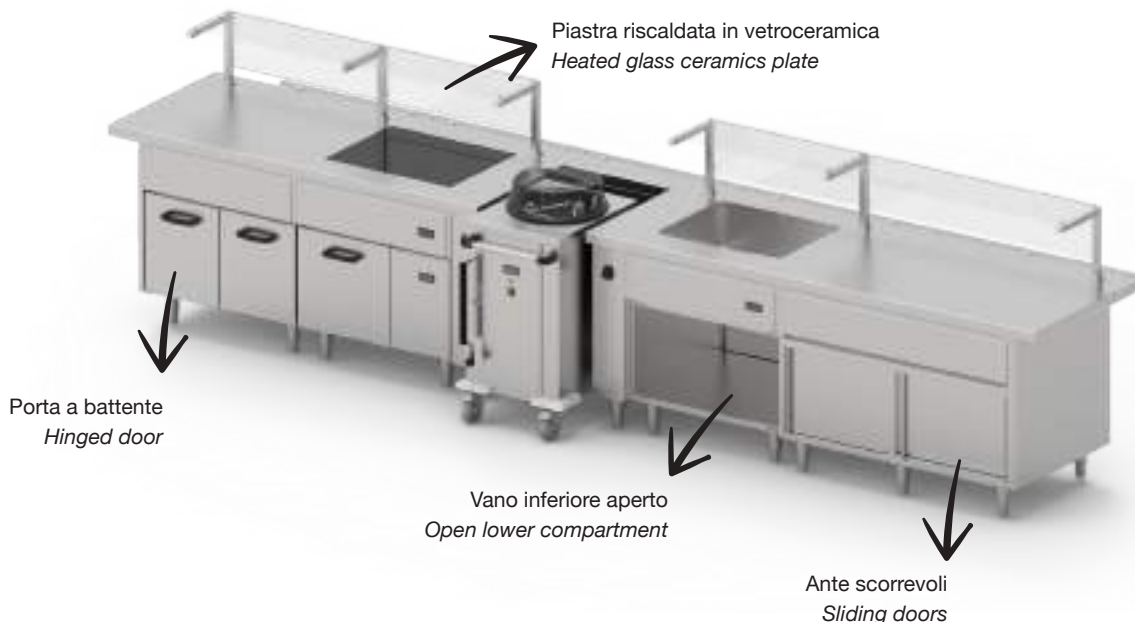
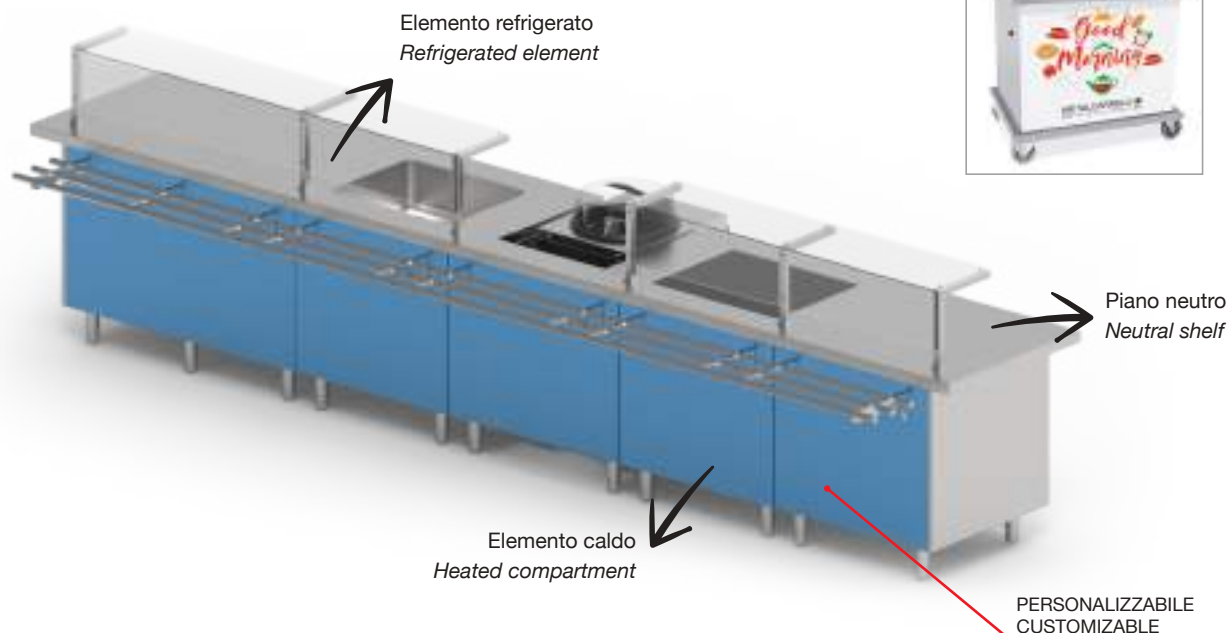

LEGENDA PER COMPORRE I CODICI DEI MODULI
KEY FOR COMPOSING MODULE CODES

CODICE / CODE	DESCRIZIONE / DESCRIPTION
LS	Linea Self / Self service line
P	Piano / Top
V	Vasca / Well
N	Neutro / Neutral
C	Caldo / Hot
F	Freddo / Cold
G	Giorno / Open compartment
M	Mantenitore / Insulated
S	Scorrevoli / Sliding
A	Armadiato / Cupboard

CODICE / CODE	DESCRIZIONE / DESCRIPTION
IC	Inserimento carrelli / Cart insert
NP	No prese / No plugs
1S	1 Schuko / 1 Schuko plug
1C	1 Presa CEE / 1 CEE plug
AE	Angolare esterno / exterior corner
AI	Angolare interno / interior corner
PV	Piano vetrina / display shelf

SCHEDE TECNICHE
TECHNICAL SHEETS

ELEMENTO VETRINETTA **DISPLAY ELEMENT**

MODELLO / MODEL	LS3PV	LS3PV
Dimensioni esterne (mm) / External dimensions (mm)		
Lunghezza / Length	3GN	1000
	4GN	1500
Profondità / Depth	820	820
Tipo di vetrina / Display	REFRIGERATA REFRIGERATED	REFRIGERATA REFRIGERATED
Temperatura vetrina / Display temperature	+4 / +12	+4 / +12
Illuminazione / Lighting	✓	✓
Tipo fluido refrigerante / Cooling fluid type	R404A	R404A
Sbrinamento automatico / Automatic defrosting	✓	✓
Potenza [kW] / Power [kW]	0,6	0,6
Tensione di alimentazione / Power supply	230V 1F+N+T	230V 1F+N+T

ELEMENTO ANGOLARE **CORNER ELEMENT**

MODELLO / MODEL	LSAE90	LSAE45	LSAI90	LSAI45
ANGOLO / CORNER	ESTERNO 90° EXTERIOR 90°	ESTERNO 45° EXTERIOR 45°	INTERNO 90° INTERIOR 90°	INTERNO 45° INTERIOR 45°
Dimensioni esterne (mm) / External dimensions (mm)				
Profondità / Depth	820	820	820	820
Profondità con bancalina / Depth with shelf	1120	1120	1120	1120

ELEMENTO INSERIMENTO CARRELLI

ELEMENT WITH CART INSERT

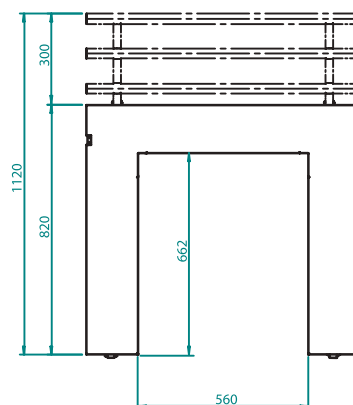
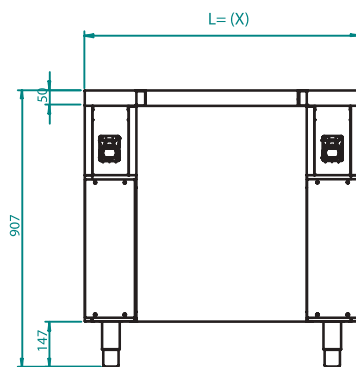

MODELLO / MODEL	LS (X*) ICNP	LS (X*) IC1S	LS (X*) IC1C	LS (X*) IC2S	LS (X*) IC2C
Dimensioni esterne (mm) / External dimensions (mm)					
Lunghezza / Length	(X*)=2	1000	1000	1000	1000
	(X*)=3	1500	1500	1500	1500
	(X*)=4	2000	2000	2000	2000
Profondità / Depth	820	820	820	820	820
Profondità con bancalina / Depth with shelf	1120	1120	1120	1120	1120
Prese CEE / CEE plugs	-	-	1	-	2
Prese SCHUKO / SCHUKO plugs	-	2	-	2	-
Tensione di alimentazione / Power supply	230V 1F+N+T	230V 1F+N+T	230V 1F+N+T	230V 1F+N+T	230V 1F+N+T

ELEMENTO CON VASCA REFRIGERATA

ELEMENT WITH REFRIGERATED WELL

MODELLO / MODEL	LS (X*) VFG	LS (X*) VFF	LS (X*) VFM	LS (X*) VFA	LS (X*) VFS
Dimensioni esterne (mm) / External dimensions (mm)					
Lunghezza / Length	(X*)=2	1000	1000	1000	1000
	(X*)=3	1500	1500	1500	1500
	(X*)=4	2000	2000	2000	2000
Profondità / Depth	820	820	820	820	820
Profondità con bancalina / Depth with shelf	1120	1120	1120	1120	1120
Vano / Compartment	GIORNO OPEN	FREDDO VENTILATO COIBENTATO COLD VENTILATED INSULATED	NEUTRO MANTENITORE COIBENTATO NEUTRAL WARM KEEPING INSULATED	NEUTRO NEUTRAL	NEUTRO NEUTRAL
Tipo di porte / Doors	-	Battenti Hinged doors	Battenti Hinged doors	Battenti Hinged doors	Scorrevoli Sliding doors
Capacità vano (Bacinelle GN) / Lower compartment capacity (GN)					
	(X*)=2	-	4 x GN 1/1	4 x GN 1/1	-
	(X*)=3	-	8 x GN 1/1	8 x GN 1/1	-
	(X*)=4	-	12 x GN 1/1	12 x GN 1/1	-
Temperatura di esercizio vasca / Basin working temperature	+2 / +10	+2 / +10	+2 / +10	+2 / +10	+2 / +10
Temperatura di esercizio vano / Lower compartment working temperature	-	+2 / +10	-	-	-
Tipo di fluido refrigerante / Cooling fluid type	R 290	R 290	R 290	R 290	R 290
Sbrinamento automatico / Automatic defrosting	✓	✓	✓	✓	✓
Diametro scarico acqua / Water drain diameter	1/2	1/2	1/2	1/2	1/2
Tensione di alimentazione / Power supply	230V 1F+N+T	230V 1F+N+T	230V 1F+N+T	230V 1F+N+T	230V 1F+N+T

ELEMENTO CON PIANO IN VETROCERAMICA

ELEMENT WITH CERAMIC GLASS TOP

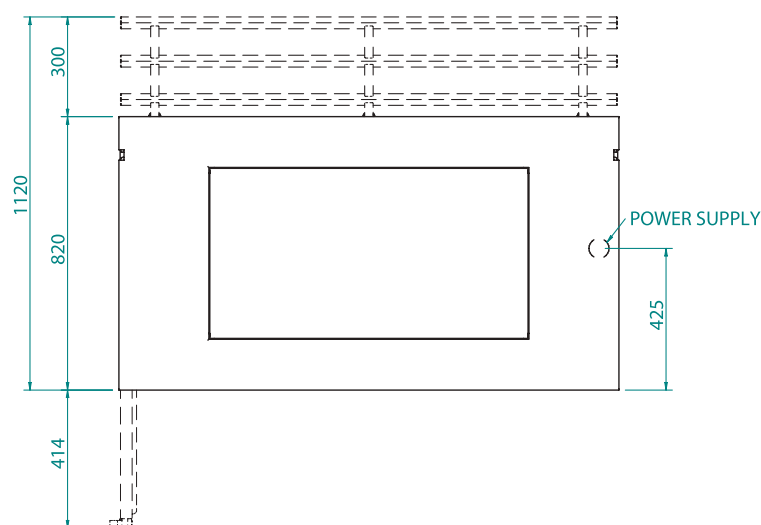
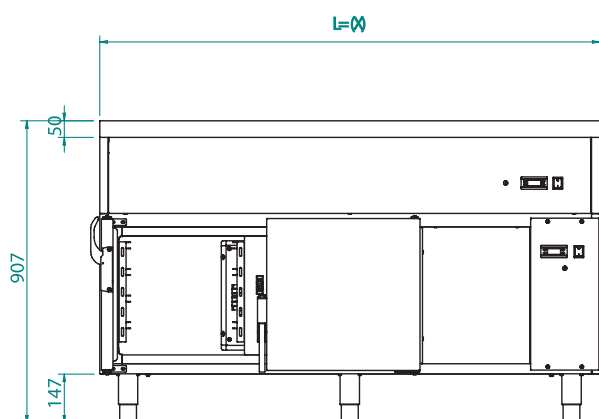

MODELLO / MODEL		LS (X*) PCG	LS (X*) PCC	LS (X*) PCM	LS (X*) PCA	LS (X*) PCS
Dimensioni esterne (mm) / External dimensions (mm)						
Lunghezza / Length	(X*)=2	1000	1000	1000	1000	1000
	(X*)=3	1500	1500	1500	1500	1500
	(X*)=4	2000	2000	2000	2000	2000
Profondità / Depth		820	820	820	820	820
Profondità con bancalina / Depth with shelf		1120	1120	1120	1120	1120
Vano / Compartment		GIORNO OPEN	CALDO VENTILATO COIBENTATO HOT VENTILATED INSULATED	NEUTRO MANTENITORE COIBENTATO NEUTRAL WARM KEEPING INSULATED	NEUTRO NEUTRAL	NEUTRO NEUTRAL
Tipo di porte / Doors		-	Battenti Hinged doors	Battenti Hinged doors	Battenti Hinged doors	Scorrevoli Sliding doors
Capacità vano (Bacinelle GN) / Lower compartment capacity (GN)						
(X*)=2		-	4 x GN 1/1	4 x GN 1/1	-	-
(X*)=3		-	8 x GN 1/1	8 x GN 1/1	-	-
(X*)=4		-	12 x GN 1/1	12 x GN 1/1	-	-
Potenza piano vetroceramica [kW] / Glass ceramic plate power (kW)						
(X*)=2		1200	1200	1200	1200	1200
(X*)=3		1800	1800	1800	1800	1800
(X*)=4		2400	2400	2400	2400	2400
Potenza vano [kW] / Lower compartment power (kW)	(X*)=2	-	600	-	-	-
	(X*)=3	-	900	-	-	-
	(X*)=4	-	1200	-	-	-
Temperatura di esercizio piano / Top working temperature		+30 / +120	+30 / +120	+30 / +120	+30 / +120	+30 / +120
Temperatura di esercizio vano / Lower compartment working temperature		-	+30 / +90	-	-	-
Tensione di alimentazione / Power supply		230V 1F+N+T	230V 1F+N+T	230V 1F+N+T	230V 1F+N+T	230V 1F+N+T

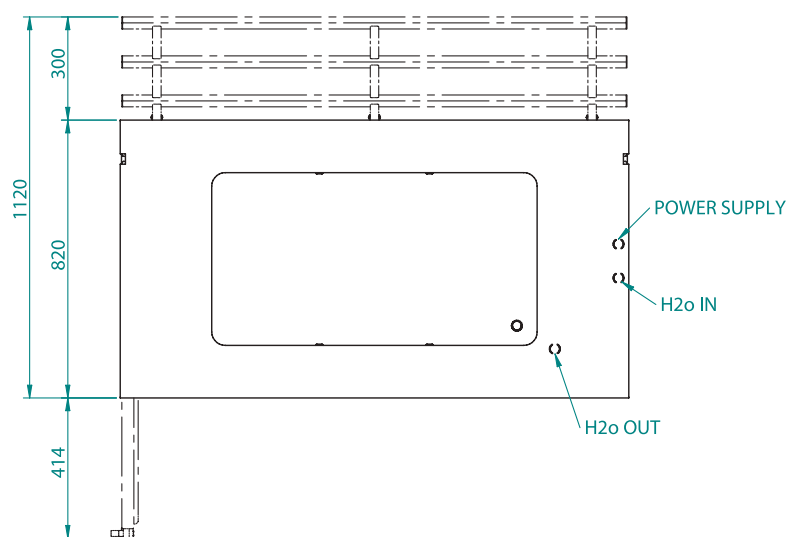
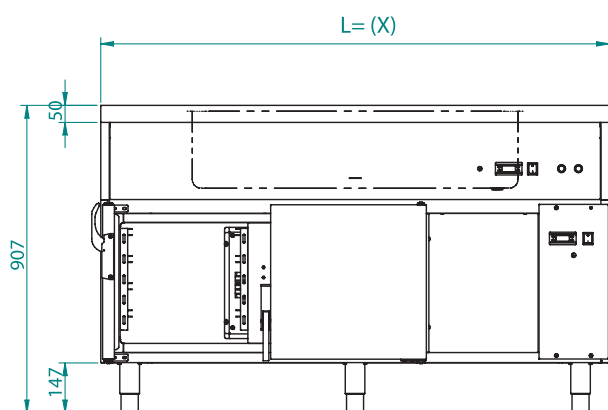

MODELLO / MODEL		LS (X*) VCG	LS (X*) VCC	LS (X*) VCM	LS (X*) VCA	LS (X*) VCS
Dimensioni esterne (mm) / External dimensions (mm)						
Lunghezza / Length	(X*)=2	1000	1000	1000	1000	1000
	(X*)=3	1500	1500	1500	1500	1500
	(X*)=4	2000	2000	2000	2000	2000
Profondità / Depth		820	820	820	820	820
Profondità con bancalina / Depth with shelf		1120	1120	1120	1120	1120
Vano / Compartment		GIORNO OPEN	CALDO VENTILATO COIBENTATO HOT VENTILATED INSULATED	NEUTRO MANTENITORE COIBENTATO NEUTRAL WARM KEEPING INSULATED	NEUTRO NEUTRAL	NEUTRO NEUTRAL
Tipo di porte / Doors		-	Battenti Hinged doors	Battenti Hinged doors	Battenti Hinged doors	Scorrevoli Sliding doors
Capacità vano (Bacinelle GN) / Lower compartment capacity (GN)						
		(X*)=2	-	4 x GN 1/1	4 x GN 1/1	-
		(X*)=3	-	8 x GN 1/1	8 x GN 1/1	-
		(X*)=4	-	12 x GN 1/1	12 x GN 1/1	-
Potenza vasca [kW] / Basin power (kW)	(X*)=2	1000	1000	1000	1000	1000
	(X*)=3	1500	1500	1500	1500	1500
	(X*)=4	2000	2000	2000	2000	2000
Potenza vano [kW] / Lower compartment power (kW)	(X*)=2	-	600	-	-	-
	(X*)=3	-	900	-	-	-
	(X*)=4	-	1200	-	-	-
Temperatura di esercizio piano / Top working temperature		+30 / +90	+30 / +90	+30 / +90	+30 / +90	+30 / +90
Temperatura di esercizio vano / Lower compartment working temperature		-	+30 / +90	-	-	-
Diametro carico acqua / Water load diameter		3/4	3/4	3/4	3/4	3/4
Diametro scarico acqua / Water drain diameter		1/2	1/2	1/2	1/2	1/2
Tensione di alimentazione / Power supply		230V 1F+N+T	230V 1F+N+T	230V 1F+N+T	230V 1F+N+T	230V 1F+N+T

ELEMENTO CON PIANO NEUTRO

ELEMENT WITH NEUTRAL TOP

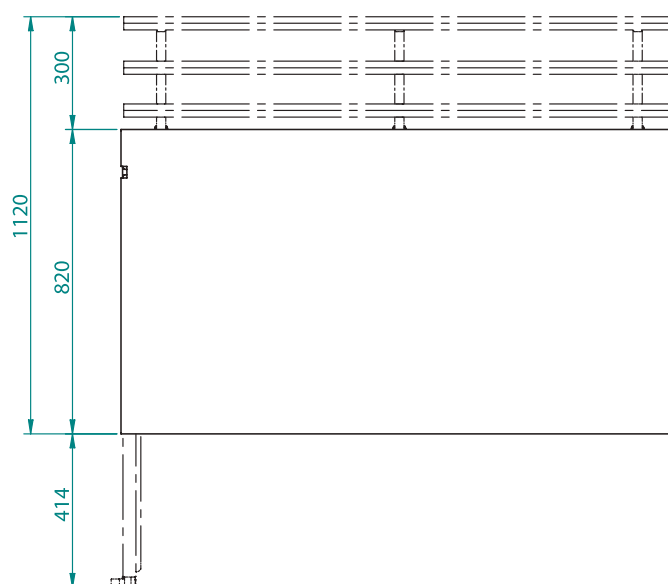
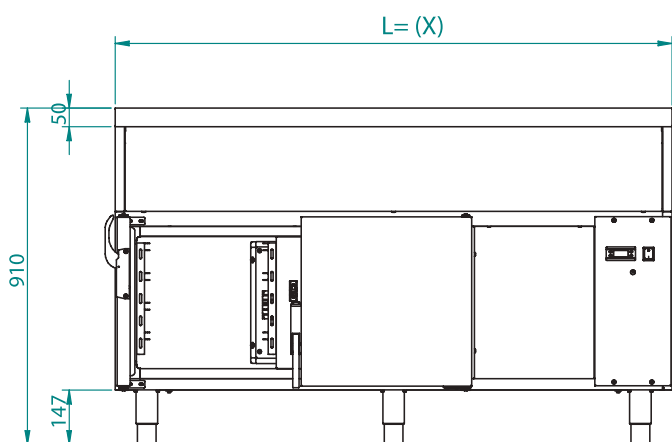

MODELLO / MODEL	LS (X*) PNG	LS (X*) PNC	LS (X*) PNF	LS (X*) PNM	LS (X*) PNA	LS (X*) PNS
Dimensioni esterne (mm) / External dimensions (mm)						
Lunghezza / Length	(X*)=2	1000	1000	1000	1000	1000
	(X*)=3	1500	1500	1500	1500	1500
	(X*)=4	2000	2000	2000	2000	2000
Profondità / Depth	820	820	820	820	820	820
Profondità con bancalina / Depth with shelf	1120	1120	1120	1120	1120	1120
Vano / Compartment	GIORNO OPEN	CALDO VENTILATO COIBENTATO HOT VENTILATED INSULATED	NEUTRO MANTENITORE COIBENTATO NEUTRAL WARM KEEPING INSULATED	NEUTRO NEUTRAL	NEUTRO NEUTRAL	NEUTRO NEUTRAL
Tipo di porte / Doors	-	Battenti Hinged doors	Battenti Hinged doors	Battenti Hinged doors	Scorrevoli Sliding doors	Scorrevoli Sliding doors
Capacità vano (Bacinelle GN) / Lower compartment capacity (GN)						
	(X*)=2	-	4 x GN 1/1	4 x GN 1/1	4 x GN 1/1	-
	(X*)=3	-	8 x GN 1/1	8 x GN 1/1	8 x GN 1/1	-
	(X*)=4	-	12 x GN 1/1	12 x GN 1/1	12 x GN 1/1	-
Temperatura di esercizio vano / Lower compartment working temperature	-	+30 / +90	+2 / +10	-	-	-
Tensione di alimentazione / Power supply	230V 1F+N+T	230V 1F+N+T	230V 1F+N+T	230V 1F+N+T	230V 1F+N+T	230V 1F+N+T

NASTRO TRASPORTATORE CONVEYOR BELT

- Realizzato interamente in acciaio inox AISI 304, finitura spazzolata
- Montato su piedini regolabili
- Tappeto idoneo al contatto alimentare, larghezza 30 cm
- Corde in poliuretano resistenti all'umidità, distanti fra loro 20 cm
- Lunghezze da 3 a 10 metri
- Interruttore generale
- Interruttore start-stop
- Due pulsanti di emergenza
- Fine corsa meccanico
- Velocità regolabile
- Imballato in gabbia di legno
- Alimentazione 400V/50Hz 3Ph+N+E - Kw 0,37

- *AISI 304 stainless steel structure, brushed finish*
- *On adjustable feet suitable for ground fixing*
- *Belt suitable for direct contact with food, belt width 30 cm*
- *Moisture-proof polyurethane cords, spaced 20 cm apart*
- *Available in lengths from 3 to 10 meters*
- *Main switch*
- *ON/OFF switch*
- *2 emergency stop buttons*
- *Mechanical end stop*
- *Adjustable speed*
- *Mains supply 400V/50Hz 3Ph+N+E - Kw 0,37*



NASTRO A TAPPETO BELT CONVEYOR

ARTICOLO / ARTICLE	LUNGHEZZA / LENGHT (M)
N.T.T-3	3
N.T.T-4	4
N.T.T-5	5
N.T.T-6	6
N.T.T-7	7
N.T.T-8	8
N.T.T-9	9
N.T.T-10	10

Prezzi su richiesta
Prices upon request

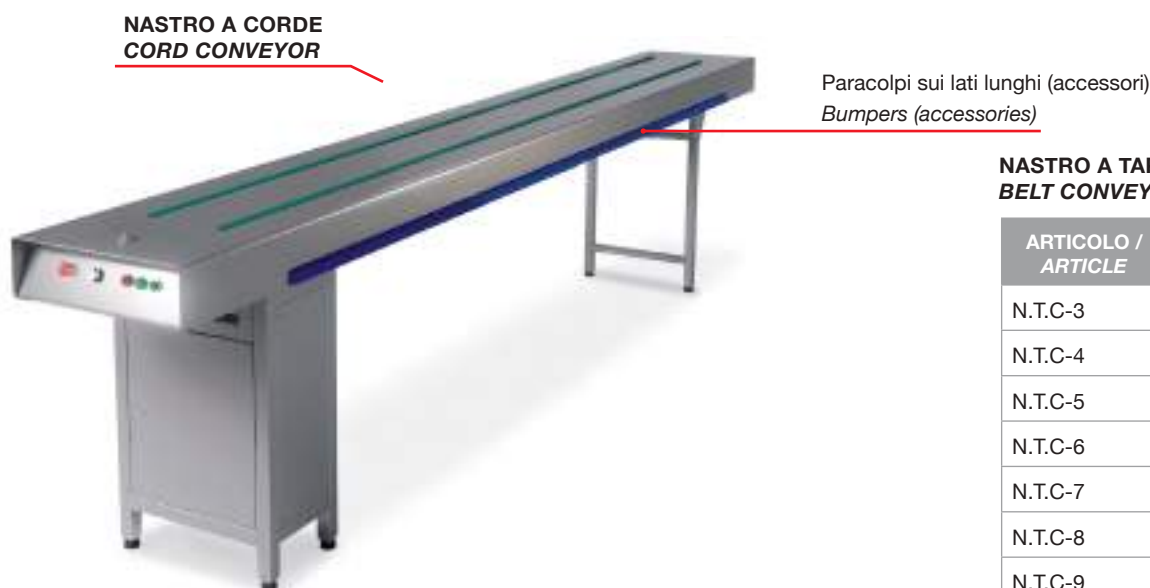

NASTRO A TAPPETO BELT CONVEYOR

ARTICOLO / ARTICLE	LUNGHEZZA / LENGHT (M)
N.T.C-3	3
N.T.C-4	4
N.T.C-5	5
N.T.C-6	6
N.T.C-7	7
N.T.C-8	8
N.T.C-9	9

Prezzi su richiesta
Prices upon request

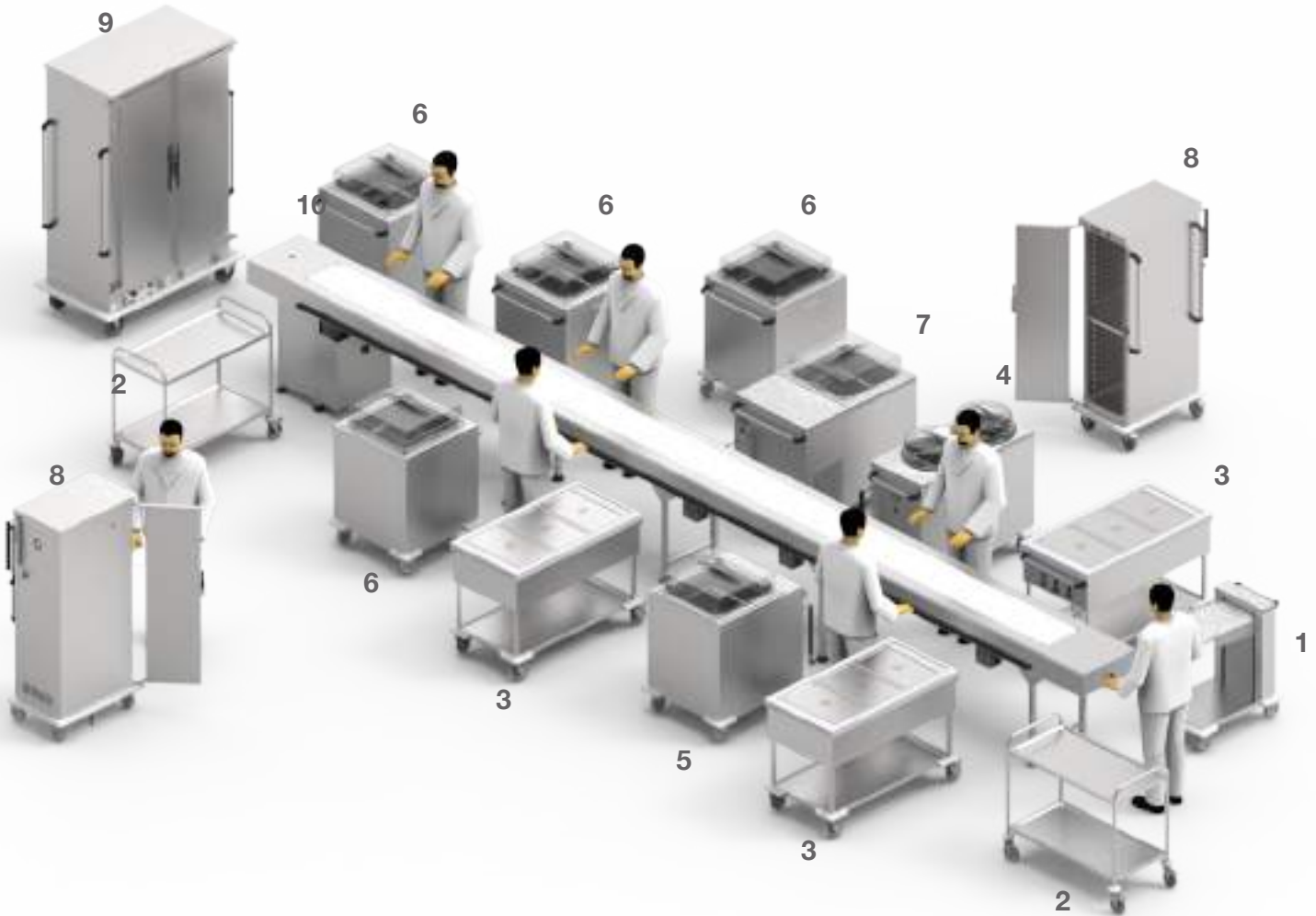

1. SOLLEVATORE VASSOI (art. 9705GN e 9705EN)
2. CARRELLO DI SERVIZIO a 2 piani per stoccare pane, posate e bicchieri
3. CARRELLO BAGNOMARIA 3 x GN 1/1 con vano inferiore a giorno (art. 7365 e 7375)
4. SOLLEVATORE PIATTI A LIVELLO COSTANTE riscaldato a 2 colonne (art. 9702-1828RC)
5. SOLLEVATORE CESTI A LIVELLO COSTANTE riscaldato per i boli (art. 9704C)
6. SOLLEVATORE CESTI A LIVELLO COSTANTE neutro per i coperchi dei boli, dei piatti o per bicchieri (art. 9704N)
7. SOLLEVATORE CESTI A LIVELLO COSTANTE refrigerato (art. 9704F)
8. ARMADIO PORTATEGLIE GN 1/1 RISCALDATO (art. 3411-20GS)
9. ARMADIO PORTAVASSOI
10. NASTRO DI CONFEZIONAMENTO A TAPPETO

1. TRAY DISPENSER (art. 9705GN and 9705EN)
2. 2-SHELF S/S SERVICE TROLLEY for bread, cutleries and glasses
3. BAIN-MARIE TROLLEY 3 x GN 1/1 WITH OPEN LOWER COMPARTMENT (art. 7365 and 7375)
4. HEATED PLATE DISPENSER WITH 2 LOWERATORS (art. 9702-1828RC)
5. HEATED RACK LOWERATOR TROLLEY FOR BOWLS (art. 9704C)
6. NEUTRAL RACK LOWERATOR TROLLEY FOR BOWLS, LIDS AND GLASSES (art. 9704N)
7. REFRIGERATED RACK LOWERATOR TROLLEY (art. 9704F)
8. HEATED GN 1/1 PAN MOBILE CUPBOARD (art. 3411-20GS)
9. TRAY/PAN MOBILE CUPBOARD
10. CARPET CONVEYOR BELT

ACCESSORI / ACCESSORIES	DESCRIZIONE / DESCRIPTION
N.T.T-Q 1-8	Pannello elettrico da 1 a 8 prese <i>Control panel from 1 to 8 sockets</i>
N.T.T-Q 9-16	Pannello elettrico da 9 a 16 prese <i>Control panel from 9 to 16 sockets</i>
N.T.T-PS-1	Presse elettrica singola 230V CEE <i>Single electrical socket 230V CEE</i>
N.T.T-PDC-1	Presse elettrica doppia contrapposta 230V CEE <i>Double opposed electrical sockets 230V CEE</i>
N.T.T-PS-2	Presse elettrica singola 230V Schuko <i>Single electrical socket 230V Schuko</i>
N.T.T-PDC-2	Presse elettrica doppia contrapposta 230V Schuko <i>Double opposed electrical sockets 230V Schuko</i>

ACCESSORI / ACCESSORIES	DESCRIZIONE / DESCRIPTION
N.T.T-PLL	Paracolpi (montati sui lati lunghi) <i>Bumpers (fitted on the long sides)</i>
N.T.T-PR	Pianetto laterale ribaltabile da 50x30 cm <i>Folding side shelf 50x30 cm</i>
N.T.T-MP	Mensola portamenu girevole da 50x30 cm <i>Turning menu holder 50x30 cm</i>
N.T.T-SSB	Pulsante start/stop aggiuntivo <i>Additional start/stop button</i>
N.T.T-RUO	Montaggio su ruote Ø cm 12,5 <i>On castors ø 12.5 cm</i>

SOLLEVATORI VASSOI A LIVELLO COSTANTE TRAY DISPENSERS

- Struttura in lamiera di acciaio inox AISI 304, finitura spazzolata
 - Maniglia di spinta
 - Adatto a contenere vassoi GN 1/1 - EN (altri formati del pianale su richiesta)
 - 1 colonna a giorno
 - Sistema di sollevamento regolabile in base al peso
 - Paracolpi in gomma angolari
 - Ruote \varnothing cm 12,5, di cui 2 con freno
-
- *AISI 304 stainless steel sheet construction, brushed finish*
 - *Pushing handle*
 - *Suitable for GN 1/1 – EN trays (platform available in other formats upon request)*
 - *1 open elevating column*
 - *Lifting system adjustable according to the weight*
 - *Rubber corner bumpers*
 - *Castors \varnothing 12.5 cm, 2 with brake*



Art. 9705GN

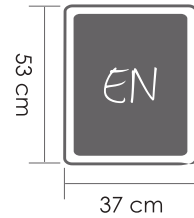
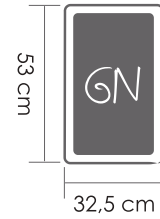

FORMATI
SU RICHIESTA
FORMATS
ON REQUEST

Maniglia di spinta
Pushing handle



ARTICOLO / ARTICLE	PREZZO / PRICE	VASSOI / TRAYS	MAX DIM. CM
9705GN	€ 1.263,00	1/1 GN	81x52x90 h
9705EN	€ 1.263,00	EN	

VERSIONE NEUTRA

- Struttura in lamiera di acciaio inox AISI 304, finitura spazzolata
- Maniglia di spinta isolata
- N. 1 o 2 cilindri, adatti ad ospitare piatti di differenti diametri (a seconda del modello), regolazione del carico tramite una serie di molle
- Coperchi inclusi
- Paracolpi in gomma angolari
- Ruote piroettanti ø cm 12,5, di cui 2 con freno

VERSIONE RISCALDATA

- Come versione neutra, in aggiunta:
- Interruttore di accensione con spia luminosa
- Termostato regolabile
- Riscaldamento ventilato
- Tensione rete 230 Volt monofase-50 Hz, 60 Hz a richiesta
- Cavo di alimentazione spiralato, lunghezza 3 metri

VERSIONE REFRIGERABILE

- Come versione neutra, con:
- Struttura in lamiera di acciaio inox AISI 304, finitura spazzolata, asolata

NEUTRAL VERSION

- AISI 304 stainless steel sheet construction, brushed finish
- Heat-proof pushing handle
- 1 or 2 columns suitable for plates of various diameters (depending on the model), with load adjustment by springs
- Lids included
- Rubber corner bumpers
- Swivel castors ø 12.5 cm, 2 with brake

HEATED VERSION

- As in the neutral version, in addition:
- ON/OFF switch with warning light
- Adjustable thermostat
- Ventilated heating
- Mains supply: 230V, 50 Hz (60 Hz upon request), single-phase
- 3-mt long coiled power cable

REFRIGERABLE VERSION

- As in the neutral version, with:
- AISI 304 stainless steel sheet construction, brushed finish, perforated



Art. 9701-1828RN



☐ = neutro = neutral ☀ = caldo = hot ❄ = refrigerabile = refrigerable

ARTICOLO / ARTICLE	PREZZO / PRICE	TIPOLOGIA / TYPOLOGY	DESCRIZIONE / DESCRIPTION	Ø CM PIATTI / PLATE	PORTATA PIATTI / PLATE CAPACITY	POTENZA / POWER	MAX DIM. CM
9701-1828RN	€ 1.044,00	☐	1 Colonna portapiatti regolabile 1 Adjustable plate lowerator	18÷28	circa 50-60 about 50-60	-	60x50x89 h
9701-1828RC	€ 1.635,00	☀				900W	
9701-1828RR	€ 1.131,00	❄				900W	
9701-2832RN	€ 1.157,00	☐		28÷32	-		
9701-2832RC	€ 1.785,00	☀			900W		
9701-2832RR	€ 1.246,00	❄			900W		

SOLLEVATORI PIATTI A LIVELLO COSTANTE
PLATE DISPENSERS AND LOWERATORS



Art. 9702-1828RR



Art. 9702-1828RC

☰ = neutro = neutral ☀ = caldo = hot ☄ = refrigerabile = refrigerable

ARTICOLO / ARTICLE	PREZZO / PRICE	TIPOLOGIA / TYPOLOGY	DESCRIZIONE / DESCRIPTION	Ø CM PIATTI / PLATE	PORTATA PIATTI / PLATE CAPACITY	POTENZA / POWER	MAX DIM. CM
9702-1828RN	€ 1.586,00	☰	2 Colonne portapiatti regolabili	18÷28	circa 100-120	-	95x50x89 h
9702-1828RC	€ 2.331,00	☀				900W	
9702-1828RR	€ 1.674,00	☄	2 Adjustable plate lowerators	28÷32	about 100-120	-	
9702-2832RN	€ 1.756,00	☰				900W	
9702-2832RC	€ 2.485,00	☀					
9702-2832RR	€ 1.843,00	☄					

ACCESSORI / ACCESSORIES	PREZZO / PRICE	DESCRIZIONE / DESCRIPTION	PER / FOR
9703-1828	€ 118,00	1 coperchio 1 lid	9701-1828RN / 9701-1828RC / 9701-1828RR 9702-1828RN / 9702-1828RC / 9702-1828RR
9703-2832	€ 136,00		9701-2832RN / 9701-2832RC / 9701-2832RR 9702-2832RN / 9702-2832RC / 9702-2832RR

SOLLEVATORI CESTI A LIVELLO COSTANTE NEUTRI / REFRIGERABILI / CALDI
 NEUTRAL/HEATED/REFRIGERABLE RACK LOWERATOR TROLLEYS

VERSIONE NEUTRA

- Struttura in lamiera di acciaio inox AISI 304, finitura spazzolata
- Maniglia di spinta
- Colonna adatta ad ospitare cesti cm 50x50, regolazione del carico tramite molle
- Cesto scorrevole con finitura rilsanizzata
- Coperchio in policarbonato con supporto laterale per aggancio in posizione di riposo
- Paracolpi angolari in gomma grigia antitraccia
- N. 4 ruote piroettanti di cui 2 con freno, ø cm 12,5

VERSIONE RISCALDATA

- Come versione neutra, in aggiunta:
- Interruttore di accensione con spia luminosa
- Termostato regolabile
- Riscaldamento ventilato
- Tensione rete 230 Volt monofase-50 Hz, 60 Hz a richiesta
- Cavo di alimentazione spiralato, lunghezza 3 metri

VERSIONE REFRIGERABILE

- Come versione neutra, con:
- Struttura in lamiera di acciaio inox AISI 304, finitura spazzolata, asolata

NEUTRAL VERSION

- AISI 304 stainless steel sheet construction, brushed finish
- Pushing handle
- One column suitable for 50x50 cm racks, load adjustment by springs
- Sliding rack, rilsan finish
- Polycarbonate lid with side support for hooking when in rest position
- Grey non marking rubber corner bumpers
- 4 swivel castors ø 12.5 cm, 2 with brake

HEATED VERSION

- As in the neutral version, in addition:
- ON/OFF switch with warning light
- Adjustable thermostat
- Ventilated heating
- Mains supply: 230V, 50 Hz (60 Hz upon request), single-phase
- 3-mt long coiled power cable

REFRIGERABLE VERSION

- As in the neutral version, with:
- AISI 304 stainless steel sheet construction, brushed finish, perforated

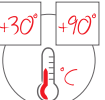

Art. 9704N



Art. 9704R



Art. 9704C

= neutro / = neutral
 = caldo / = hot
 = refrigerabile / = refrigerable

ARTICOLO / ARTICLE	PREZZO / PRICE	TIPOLOGIA / TYPOLOGY	CAPACITÀ DI CARICO / LOADING CAPACITY	POTENZA / POWER	MAX DIM. CM
9704N	€ 1.821,00		5 cesti cm 50x50x11,5 h 9 cesti cm 50x50x 7,5 h	-	76x79,4x93 h h 108 (con coperchio / with lid)
9704R	€ 2.068,00		5 racks cm 50x50x11.5 h 9 racks cm 50x50x 7.5 h	-	76x79,4x93 h h 108 (con coperchio / with lid)
9704C	€ 2.455,00			900W	76x89,4x93 h h 108 (con coperchio / with lid)

SOLLEVATORE CESTI A LIVELLO COSTANTE REFRIGERATO REFRIGERATED RACK LOWERATOR TROLLEY

- Struttura in acciaio inox AISI 304 coibentata, finitura spazzolata
- Maniglia di spinta
- Colonna adatta ad ospitare cesti cm 50x50, regolazione del carico tramite molle
- Cesto scorrevole con finitura rilsanizzata
- Coperchio in policarbonato con supporto laterale per aggancio in posizione di riposo
- Refrigerazione ventilata +2°C+10°C
- Sbrinamento ed evaporazione condensa automatici
- Pannello comandi integrato dotato di interruttore di accensione con spia luminosa e termostato digitale, cavo di alimentazione spiralato
- Alimentazione 230 V monofase- 50 Hz, 60 Hz a richiesta
- Paracolpi angolari in gomma grigia antitraccia
- N. 4 ruote piroettanti di cui 2 con freno, ø cm 12,5

- *AISI 304 stainless steel insulated structure, brushed finish*
- *Pushing handle*
- *One column suitable for 50x50 cm racks, load adjustment by springs*
- *Sliding rack, rilsan finish*
- *Polycarbonate lid with side support for hooking when in rest position*
- *Ventilated refrigeration +2°C +10°C*
- *Automatic defrosting and condensation evaporation*
- *Control panel with ON/OFF switch with warning light and digital thermostat, coiled power cable*
- *Power supply 230V – 50 Hz (60 Hz upon request), single-phase*
- *Grey non marking rubber corner bumpers*
- *4 swivel castors ø 12.5 cm, 2 with brake*

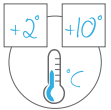

Art. 9704F

 = refrigerabile
= refrigerable

ARTICOLO / ARTICLE	PREZZO / PRICE	TIPOLOGIA / TYPOLOGY	CAPACITÀ DI CARICO / LOADING CAPACITY	POTENZA / POWER	MAX DIM. CM
9704F	€ 5.860,00		5 cesti cm 50x50x11,5 h 9 cesti cm 50x50x7,5 h 5 racks cm 50x50x11.5 h 9 racks cm 50x50x7.5 h	167 W	121x75x94 h h 108 (con coperchio / with lid)

ACCESSORI / ACCESSORIES	PREZZO / PRICE		DESCRIZIONE / DESCRIPTION	PER / FOR	DIM. CM
9704-115CEST	€ 213,00	1	Cesto in acciaio inox <i>Stainless steel rack</i>	9704N / 9704R 9704C / 9704F	50x50x11.5 h
9704-75CEST	€ 200,00	-		9704N / 9704R 9704C / 9704F	50x50x7.5 h

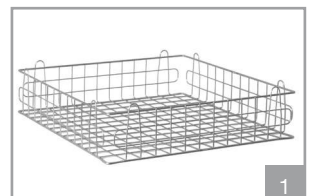

- Struttura in tubo quadro cm 2,5x2,5 e pannelli in lamiera di acciaio inox AISI 304, finitura spazzolata
- Coibentazione realizzata con pannelli in poliuretano espanso
- Maniglia di spinta isolata
- Piano inferiore a giorno saldato al telaio
- Vasca bagnomaria stampata con bordi arrotondati, adatta a contenere bacinelle GN, fino a cm 20 h (escluse)
- Rubinetto per lo scarico dell'acqua del bagnomaria
- Riscaldamento a umido-bagnomaria, con resistenza esterna alla vasca
- Riscaldamento a secco: caratteristiche e costo a richiesta
- Interruttore di accensione con spia luminosa
- Pannello comandi con termostato regolabile
- Tensione rete 230 Volt monofase-50/60Hz
- Paracolpi in gomma angolari
- Ruote piroettanti ø cm 12,5

- 2,5x2,5 cm square steel tube construction with AISI 304 stainless steel sheet panels, brushed finish
- Polyurethane foam insulation panels
- Heat-proof pushing handle
- Lower welded shelf
- Bain-Marie well made of pressed steel sheet with no sharp edges for up to 20 cm deep GN pans (not included)
- Bain-Marie drain tap
- Bain-marie heating with heating element outside the well
- Dry heating: details and quotes upon request
- ON/OFF switch with warning light
- Control panel with adjustable thermostat
- Mains supply 230V, 50/60Hz, single-phase
- Rubber corner bumpers
- Swivel castors, ø cm 12.5

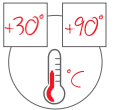

Art. 7365-F

Optional bacinelle vedi pag. 78-79
Optional Gastronorms: see pp. 78-79



Art. 7375-F

ARTICOLO / ARTICLE	PREZZO / PRICE	GN	POTENZA / POWER	MAX DIM. CM
7360	€ 1.734,00	2/1	1200W	87x65x86 h
7365	€ 2.081,00	3/1	1500W	125x65x86 h
7368	€ 2.474,00	4/1	2400W	163x65x86 h
7370	€ 1.770,00	2x1/1	1200W	87x65x86 h
7375	€ 2.538,00	3x1/1	1800W	125x65x86 h
7378	€ 3.032,00	4x1/1	2400W	163x65x86 h

OPTIONAL	PREZZO / PRICE	DESCRIZIONE / DESCRIPTION	PER / FOR
F	€ 28,00	Set 2 ruote con freno Set with 2 braked castors	Tutti gli articoli All Articles



1

CARRELLI REFRIGERANTI IN ACCIAIO INOX STAINLESS STEEL REFRIGERATED TROLLEYS

- Struttura in tubo quadro cm 2,5x2,5 e pannelli in lamiera di acciaio inox AISI 304, finitura spazzolata
- Maniglia laterale di spinta
- Ripiano inferiore di servizio
- Vasca in acciaio inox AISI 304 profonda 19 cm, per bacinelle GN fino a cm 15 h (escluse)
- Scarico condensa della vasca chiuso con rubinetto
- Pannello comandi con termostato-termometro digitale e interruttore di accensione con spia luminosa
- Tensione rete 230 Volt monofase 50Hz, 60Hz a richiesta
- Refrigerazione statica +4°C +10°C
- Paracolpi in gomma grigia antitraccia
- Ruote piroettanti ø cm 12,5, di cui 2 con freno

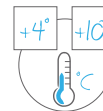

- 2.5x2.5 cm square tube construction and panels in AISI 304 stainless steel sheet, brushed finish
- Side pushing handle
- Lower shelf
- AISI 304 stainless steel 19 cm-deep well for up to 15 cm-deep GN pans (not included)
- Condensate drain at the base of the well with drain tap
- Control panel with digital thermostat-thermometer and ON/OFF switch with warning light
- Mains supply: 230V, 50Hz (60Hz upon request), single-phase
- Static refrigeration +4°C +10°C
- Grey non marking rubber bumper
- Swivel castors ø 12.5 cm, 2 with brake



Optional bacinelle vedi pag. 78-79
Optional Gastronorms: see pp. 78-79

Art. 6962.3

ARTICOLO / ARTICLE	PREZZO / PRICE	GN	POTENZA / POWER	MAX DIM. CM
6962.2	€ 2.993,00	2x1/1	190W	87x75x88 h
6962.3	€ 3.472,00	3x1/1	350W	120x75x88 h
6962.4	€ 4.090,00	4x1/1	450W	168x75x88 h

OPTIONAL	PREZZO / PRICE		DESCRIZIONE / DESCRIPTION	GN	
CUP2	€ 719,00	1	Cupola semicilindrica con apertura su due lati <i>Plexiglass semi-cylindrical dome opening on both sides</i>	2x1/1	
CUP3	€ 785,00			3x1/1	
CUP4	€ 850,00			4x1/1	
A132	€ 131,00	2	Mensola inox frontale, ribaltabile <i>Front drop-down shelf</i>	2x1/1	
A133	€ 148,00			3x1/1	
A134	€ 196,00			4x1/1	
A142	€ 145,00	3	Mensola in tubo inox frontale, ribaltabile <i>Front drop-down stainless steel rodde tray slide</i>	2x1/1	
A143	€ 161,00			3x1/1	
A144	€ 206,00			4x1/1	

ACCESSORI / ACCESSORIES	PREZZO / PRICE		DESCRIZIONE / DESCRIPTION	PER / FOR	
A10	€ 39,00	4	Griglia liscia 1/1 GN / 1/1 GN Flat	Tutti gli articoli <i>All Articles</i>	
A20	€ 46,00	5	Griglia asolata 1/1 GN / 1/1 GN Perforated		

- Struttura in acciaio inox AISI 304 coibentata, finitura spazzolata
- 1 Sportello frontale a battente, apribile a 270°, con magnete di bloccaggio a porta aperta
- Guarnizione sportello estraibile
- Maniglia di apertura con chiusura a scatto, optional con serratura
- Maniglia di spinta
- Vano interno con angoli arrotondati (soddisfa il requisito igienico H1) predisposto per teglie GN
- Gruppo riscaldante ventilato con motoventilatore e resistenza
- Pannello comandi integrato, dotato di interruttore di accensione con spia luminosa, termostato-termometro digitale, sul retro cavo di alimentazione spiralato
- Tensione rete 230 Volt monofase – 50/60Hz
- Possibilità di umidificare il vano interno tramite apposita vaschetta con acqua
- Paracolpi perimetrale in gomma grigia antitraccia
- Ruote ø cm 12,5 piroettanti, di cui 2 con freno

- *AISI 304 stainless steel insulated structure, brushed finish*
- *270° opening front door with magnet (to keep the door open)*
- *Removable door gasket*
- *Handle with snap closure, optional with lock*
- *Pushing handle*
- *Inside compartment made with round corners in compliance with H1 hygiene standard, suitable for GN pans*
- *Ventilated heating unit powered with fan and heating element*
- *Control panel with ON/OFF switch with operation warning light and digital thermostat, coiled power cord on the backside*
- *Mains supply: 230V - 50 Hz (60 Hz upon request), single-phased*
- *Water container to release moisture inside the cupboard*
- *All round grey non marking rubber bumper*
- *Swivel castors, ø cm 12.5, 2 with brake*



Guide stampate

Costruite con un unico foglio di lamiera, facilitano la pulizia

Pressed runners

made with one single sheet layer for easy cleaning

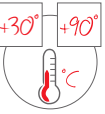

Vano con angoli arrotondati
soddisfano il requisito igienico "H1"

Compartment with no-sharp edges
compliant with "H1" hygiene system



Porta apribile a 270°
Facilita l'inserimento delle bacinelle GN

270° opening door
To easily fit GN pans



Art. 3421-10GS



Art. 3411-20GS

ARTICOLO / ARTICLE	PREZZO / PRICE	TIPOLOGIA / TYPOLOGY	GN	SUPPORTO / RUNNERS	PASSO / SPACING CM	POTENZA / POWER	MAX DIM. CM
3411-10GS	€ 3.496,00		10 GN 1/1		5.5	1600W	55x80x110 h
3421-10GS	€ 3.854,00		10 GN 2/1				72x92x110 h
3411-20GS	€ 4.193,00		20 GN 1/1				55x80x166 h
3421-20GS	€ 4.624,00		20 GN 2/1				72x92x166 h

OPTIONAL	PREZZO / PRICE	DESCRIZIONE / DESCRIPTION	PER / FOR
E	€ 97,00	Set 4 ruote elastiche, di cui 2 con freno, per pavimenti sconnessi o per esterno <i>4 resilient castors, ø cm 12.5, 2 with brake, for uneven floors/outdoor use</i>	Tutti gli articoli <i>All Articles</i>
MA	€ 126,00	Maniglia di chiusura con serratura <i>Closure handle with lock</i>	

ACCESSORI / ACCESSORIES	PREZZO / PRICE	DESCRIZIONE / DESCRIPTION	PER / FOR
A0170	€ 47,00	Griglia in acciaio inox 1/1 GN / <i>Stainless steel wire rack 1/1 GN</i>	3411-10GS / 3411-20GS
A0171	€ 76,00	Griglia in acciaio inox 2/1 GN / <i>Stainless steel wire rack 2/1 GN</i>	3421-10GS / 3421-20GS

ARMADI PORTATEGLIE REFRIGERATI REFRIGERATED INSULATED PAN MOBILE CUPBOARD

- Struttura in acciaio inox AISI 304 coibentata, finitura spazzolata
 - 1 Sportello frontale a battente, apribile a 270° con magneti di bloccaggio a porta aperta
 - Maniglia di apertura con chiusura a scatto, optional con serratura
 - Maniglie di spinta
 - Vano interno con angoli arrotondati (soddisfa il requisito igienico H1) dotato di 16 coppie di guide stampate, predisposto per teglie 1/1 GN.
 - Refrigerazione ventilata +2°C +10°C
 - Sbrinatorio ed evaporazione condensa automatici
 - Pannello comandi integrato dotato di interruttore di accensione con spia luminosa e termostato digitale, sul retro cavo di alimentazione spiralato
 - Tensione rete 230 Volt monofase – 50/60Hz
 - Paracolpi perimetrale in gomma grigia antitraccia
 - Ruote ø cm 12,5, piroettanti, di cui 2 con freno
- *AISI 304 stainless steel insulated structure, brushed finish*
 - *270° opening front door with magnet (to keep the door open)*
 - *Handle with snap closure, optional with lock*
 - *Pushing handles*
 - *Inside compartment equipped with 16 pressed runners suitable for 1/1 GN containers made with round corners in compliance with H1 hygiene standard*
 - *Ventilated refrigeration +2°C +10°C*
 - *Automatic defrosting and evaporation*
 - *Control panel with ON/OFF switch with operation warning light and digital thermostat, coiled power cord on the backside*
 - *Mains supply: 230V - 50Hz, 60Hz upon request*
 - *All round grey non marking rubber bumper*
 - *Swivel castors, ø cm 12.5, 2 with brake*

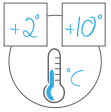

Art. 3415-16GS









ARTICOLO / ARTICLE	PREZZO / PRICE	PORTATA VASSOI-TEGLIE / TRAY-PAN CAPACITY	SUPPORTO / RUNNERS	PASSO / SPACING CM	POTENZA / POWER	MAX DIM. CM
3415-16GS	€ 5.860,00	16 x 1/1 GN		5.5	330W	55.5x79.5x165 h

OPTIONAL	PREZZO / PRICE	DESCRIZIONE / DESCRIPTION	PER / FOR
E	€ 97,00	Set 4 ruote elastiche, di cui 2 con freno, per pavimenti sconnessi o per esterno <i>4 resilient castors, ø cm 12.5, 2 with brake, for uneven floors/outdoor use</i>	Tutti gli articoli <i>All Articles</i>
MA	€ 126,00	Maniglia di chiusura con serratura <i>Closure handle with lock</i>	

ACCESSORI / ACCESSORIES	PREZZO / PRICE	DESCRIZIONE / DESCRIPTION	PER / FOR
A0170	€ 47,00	Griglia in acciaio inox 1/1 GN / <i>Stainless steel wire rack 1/1 GN</i>	3411-10GS / 3411-20GS





	PIANI CALDI <i>COUNTERTOP HOTPLATES</i>	PAG. 128
	LAMPADE RISCALDANTI <i>INFRARED LAMPS</i>	PAG. 131
	TAVOLE CALDE DA BANCO <i>COUNTERTOP BAIN-MARIE UNITS</i>	PAG. 133
	STERILIZZA COLTELLI <i>KNIFE STERILIZER</i>	PAG. 135
	TRAMOGGE <i>WASTE COLLECTORS</i>	PAG. 136
	VASCHE CARRELLATE <i>TROLLEY WELLS</i>	PAG. 137
	MOBILETTI SCALDA PIATTI <i>PLATE WARMER CABINETS</i>	PAG. 138
	COLONNE PORTAPIATTI <i>PLATE STACKERS</i>	PAG. 139
	VETRINE PORTAPIATTI RISCALDATE E REFRIGERATE <i>HEATED, REFRIGERATED DISPLAY CASES</i>	PAG. 140

PIANI CALDI COUNTERTOP HOTPLATES

- Piano in lamiera di acciaio inox AISI 304
- Riscaldamento con resistenza elettrica
- Interruttore di accensione con spia luminosa
- Termostato regolabile
- Tensione rete 230 Volt monofase-50/60 Hz
- Piedini di appoggio in gomma

- *AISI 304 stainless steel sheet top*
- *Heated by electrical heating element*
- *ON/OFF switch with warning light*
- *Adjustable thermostat*
- *Mains supply: 230V, 50/60 Hz, single-phase*
- *Rubber feet*

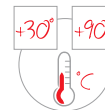

Art. 9082

ARTICOLO / ARTICLE	PREZZO / PRICE	GN	POTENZA / POWER	MAX DIM. CM
9080	€ 220,00	1x1/1	300W	33x53x6 h
9082	€ 277,00	2x1/1	600W	66x53x6 h
9084	€ 333,00	3x1/1	900W	99x53x6 h
9086	€ 385,00	4x1/1	1200W	132x53x6 h
905050	€ 272,00	-	500W	50x50x6 h
9050	€ 385,00		750W	100x50x6 h

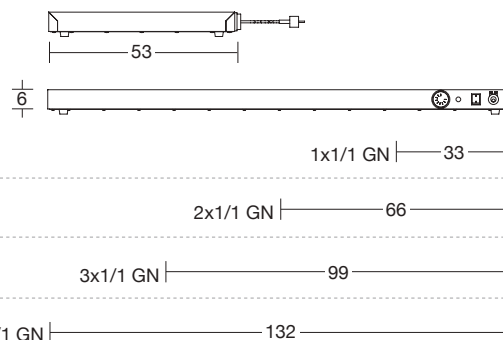

REALIZZABILI SU MISURA
LOTTO MINIMO 5PZ.
CUSTOM MADE DIMENSIONS
MIN. ORDER 5 PCS.

Larghezza max cm 132
Max width cm 132

Max depth cm 60
Profondità max cm 60

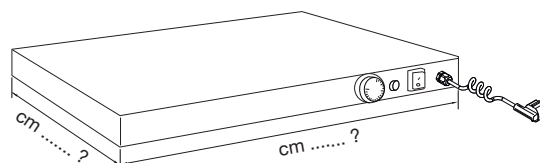

PIANI CALDI CON LAMPADE AD INFRAROSSI COUNTERTOP HOTPLATES WITH INFRARED LAMPS

- Piano in lamiera di acciaio inox AISI 304
- Telaio superiore in tubo e lamiera di acciaio inox integrato nel piano
- Parafuoco in plexiglass curvo
- Lampade ad infrarossi, potenza 250 W, di colore rosso
- Riscaldamento con resistenza elettrica
- Interruttori di accensione con spia luminosa, separati per piano caldo e lampade
- Termostato regolabile
- Tensione rete 230 Volt monofase-50/60 Hz
- Piedini di appoggio in gomma

- *AISI 304 stainless steel sheet top*
- *Built-in upper frame in tube and stainless steel sheet*
- *Plexiglass curved sneeze guard*
- *Infrared lamps, 250W each, red colour*
- *Heated by electrical heating element*
- *Separate switches for hotplate and infrared lamps, with warning light*
- *Adjustable thermostat*
- *Mains supply: 230V, 50/60 Hz, single-phase*
- *Rubber feet*

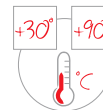

Art. 9568

ARTICOLO / ARTICLE	PREZZO / PRICE	GN	LAMPADE / LAMPS	POTENZA / POWER	MAX DIM. CM
9564	€ 507,00	1x1/1	1	550W	38x53x70 h
9566	€ 686,00	2x1/1	2	1100W	70x53x70 h
9568	€ 887,00	3x1/1	3	1650W	103x53x70 h
9570	€ 1.071,00	4x1/1	4	2200W	136x53x70 h

OPTIONAL	PREZZO / PRICE	DESCRIZIONE / DESCRIPTION	PER / FOR
LB	€ 23,00	Lampade bianche White lamps	Tutti gli articoli All Articles

LAMPADE RISCALDANTI AD INFRAROSSI INFRARED LAMPS

- Parafiatto in plexiglass curvo
- Lampade ad infrarossi, potenza 250 W, di colore rosso
- Interruttore di accensione con spia luminosa
- Tensione rete 230 Volt monofase-50/60 Hz



- *Plexiglass curved sneeze guard*
- *Infrared lamps, 250W each, red colour*
- *ON/OFF switch with warning light*
- *Mains supply: 230V, 50/60 Hz, single-phase*
- *Rubber feet*



SUPPORTO A SOSPENSIONE IN LAMIERA DI ACCIAIO INOX
STAINLESS STEEL SHEET HANGING SUPPORT

Art. 9568S



TELAIO DI APPOGGIO IN LAMIERA DI ACCIAIO INOX
STAINLESS STEEL SHEET FRAME

Art. 9568T

ARTICOLO / ARTICLE	PREZZO / PRICE	GN	LAMPADE / LAMPS	POTENZA / POWER	MAX DIM. CM
9566S	€ 450,00	2x1/1	2	500W	71x53x24 h
9568S	€ 599,00	3x1/1	3	750W	104x53x24 h
9570S	€ 738,00	4x1/1	4	1000W	137x53x24 h
9564T	€ 393,00	1x1/1	1	250W	38x53x70 h
9566T	€ 518,00	2x1/1	2	500W	70x53x70 h
9568T	€ 666,00	3x1/1	3	750W	103x53x70 h
9570T	€ 804,00	4x1/1	4	1000W	136x53x70 h

OPTIONAL	PREZZO / PRICE	DESCRIZIONE / DESCRIPTION	PER / FOR
LB	€ 23,00	Lampade bianche White lamps	Tutti gli articoli All Articles

- Portalampada con cavo spiralato regolabile in altezza
- Lampada ad infrarossi, potenza 250 W, di colore rosso oppure bianco su richiesta
- Interruttore di accensione posto sul corpo della lampada
- Tensione rete 230 Volt monofase-50/60 Hz



- Height-adjustable lamp holder
- Infrared lamp, 250 W, red colour or white colour upon request
- ON/OFF switch on lamp holder body
- Mains supply: 230V, 50/60 Hz, single-phase

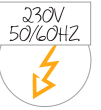

Art. 9510A



Art. 9511A



Art. 9512A



Art. 9513A

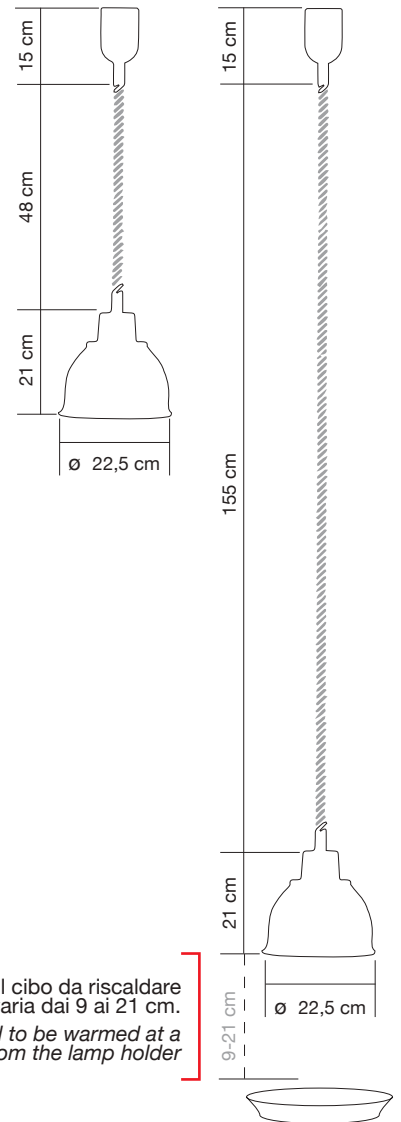

La distanza ottimale tra il cibo da riscaldare e il portalampada varia dai 9 ai 21 cm.
Better to keep the food to be warmed at a distance from 9 to 21 cm from the lamp holder

ARTICOLO / ARTICLE	PREZZO / PRICE	COLORE / COLOUR	LUNGHEZZA CAVO / CABLE LENGHT	POTENZA / POWER	MAX DIM. CM
9510A	€ 310,00	Alluminio / Aluminum	Regolabile 48 - 155 cm Adjustable 48 - 155 cm	250W	ø 22,5
9511A	€ 450,00	Cromato / Chrome			
9512A	€ 450,00	Rame / Copper			
9513A	€ 330,00	Nero / Black			
OPTIONAL	PREZZO / PRICE	DESCRIZIONE / DESCRIPTION		PER / FOR	
LB-1	23,00	Lampada bianca White lamp		Tutti gli articoli All Articles	

LAMPADE RISCALDANTI AD INFRAROSSI INFRARED LAMPS

- Portalampada con cavo spiralato regolabile in altezza
- Lampada ad infrarossi, potenza 250 W, di colore rosso oppure bianco su richiesta
- Interruttore di accensione posto sul corpo della lampada
- Tensione rete 230 Volt monofase-50/60 Hz



- *Height-adjustable lamp holder*
- *Infrared lamp, 250 W, red colour or white colour upon request*
- *ON/OFF switch on lamp holder body*
- *Mains supply: 230V, 50/60 Hz, single-phase*



Art. 9518A

Art. 9520A

Art. 9522A

Art. 9519A

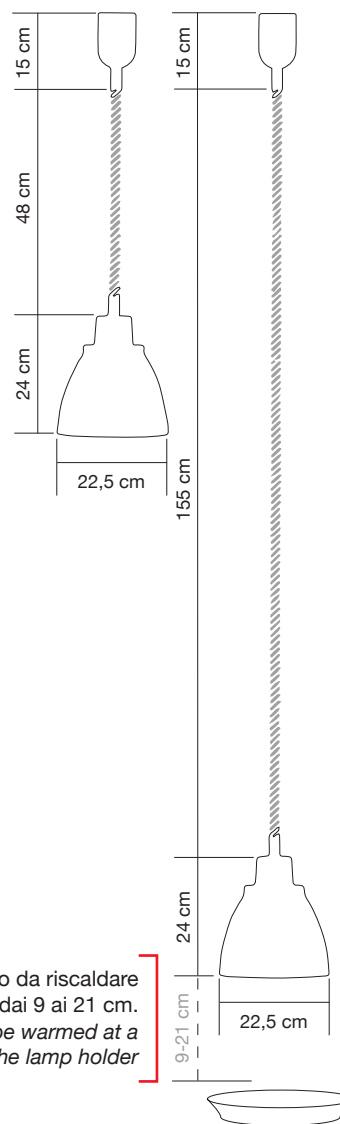

La distanza ottimale tra il cibo da riscaldare e il portalampada varia dai 9 ai 21 cm.
Better to keep the food to be warmed at a distance from 9 to 21 cm from the lamp holder

ARTICOLO / ARTICLE	PREZZO / PRICE	COLORE / COLOUR	LUNGHEZZA CAVO / CABLE LENGHT	POTENZA / POWER	MAX DIM. CM
9518A	€ 380,00	Nero / Black	Regolabile 48 - 155 cm Adjustable 48 - 155 cm	250W	ø 22,5
9519A	€ 450,00	Cromato / Chrome			
9520A	€ 330,00	Alluminio / Aluminum			
9522A	€ 450,00	Rame / Copper			
OPTIONAL	PREZZO / PRICE	DESCRIZIONE / DESCRIPTION		PER / FOR	
LB-1	€ 23,00	Lampada bianca White lamp		Tutti gli articoli All Articles	

- Struttura in acciaio inox AISI 304
- Vasca in doppia parete adatta a contenere bacinelle GN 1/1, fino a 15 cm h (escluse), temperature differenziate
- Riscaldamento a umido-bagnomaria, con resistenza esterna alla vasca
- Riscaldamento a secco: caratteristiche e costo a richiesta
- Per ogni vasca:
 - rubinetto per lo scarico dell'acqua del bagnomaria
 - termostato regolabile
 - interruttore di accensione con spia luminosa
- Tensione rete 230 Volt monofase-50/60 Hz

- *AISI 304 Stainless steel structure*
- *Double skinned steel sheet well for up to 15 cm-deep GN 1/1 pans (not included) with separate temperature control*
- *Bain-marie heating with heating element outside the well*
- *Dry heating: details and quotes upon request*
- *For each well:*
 - *Bain-Marie drain tap*
 - *Adjustable thermostat*
 - *ON/OFF switch with warning light*
- *Mains supply: 230V, 50/60 Hz, single-phase*

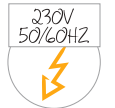
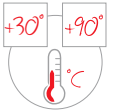

Optional bacinelle vedi pag. 78-79
Optional Gastronorms: see pp. 78-79



Art. 9555-2

ARTICOLO / ARTICLE	PREZZO / PRICE	GN	VASCA / WELL	POTENZA / POWER	MAX DIM. CM
9555-1	€ 417,00	1x1/1	Separata Separate	600W	34x60x24 h
9555-2	€ 661,00	2x1/1		1200W	70x60x24 h
9555-3	€ 889,00	3x1/1		1800W	106x60x24 h

TAVOLE CALDE DA BANCO COUNTERTOP BAIN-MARIE UNITS

- Struttura in lamiera di acciaio inox AISI 304 in doppia parete
- Vasca del bagnomaria adatta a contenere bacinelle GN, fino a 20 cm h (escluse)
- Rubinetto per lo scarico dell'acqua del bagnomaria
- Riscaldamento a bagnomaria con resistenza immersa
- Interruttore di accensione con spia luminosa
- Termostato regolabile
- Tensione rete 230 Volt monofase-50/60 Hz
- Cavo spiralato, lunghezza 3 mt. spina Schuko
- Piedini regolabili
- Utilizzabili solo a bagnomaria

- *Double skinned AISI 304 stainless steel sheet construction*
- *Bain-Marie well for up to 20 cm-deep GN pans (not included)*
- *Bain-Marie drain tap*
- *Bain-Marie immersion heating element*
- *ON/OFF switch with warning light*
- *Adjustable thermostat*
- *Mains supply: 230V, 50/60 Hz, single-phase*
- *3-m long coiled power cable, Schuko plug.*
- *Adjustable feet*
- *Bain-Marie only*

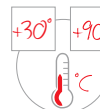

Art. 9531 + bacinelle / pans



Art. 9531+GR3

ARTICOLO / ARTICLE	PREZZO / PRICE	GN	POTENZA / POWER	MAX DIM. CM
9541	€ 750,00	1/1	1950W	49x60x34 h
9551	€ 876,00	2/1		81x60x34 h
9531	€ 999,00	3/1		114x60x34 h
9521	€ 1.144,00	4/1	3400W	153x60x34 h

ACCESSORI / ACCESSORIES	PREZZO / PRICE	GRIGLIA FONDO / BOTTOM SAFETY GRILL	PER / FOR
GR1	€ 59,00	1x1/1 GN	9541
GR2	€ 69,00	2x1/1 GN	9551
GR3	€ 80,00	3x1/1 GN	9531
GR4	€ 90,00	4x1/1 GN	9521

- Struttura in acciaio inox
- Sportello in metacrilato antidisersione raggi UV con chiusura magnetica
- Rastrelliera portacoltelli in filo di acciaio
- Microinterruttore di sicurezza per spegnimento automatico della lampada in apertura
- Interruttore di accensione
- Timer regolabile 0-60 minuti
- Tensione rete 230 Volt monofase-50 Hz

- *Stainless steel structure*
- *Methacrylate door with anti UV dispersion and magnetic closure*
- *Steel wire knife rack*
- *Safety microswitch that automatically turns the lamp OFF when opening the door*
- *ON/OFF switch*
- *Adjustable timer: 0-60 minutes*
- *Mains supply: 230V, 50 Hz, single-phase*

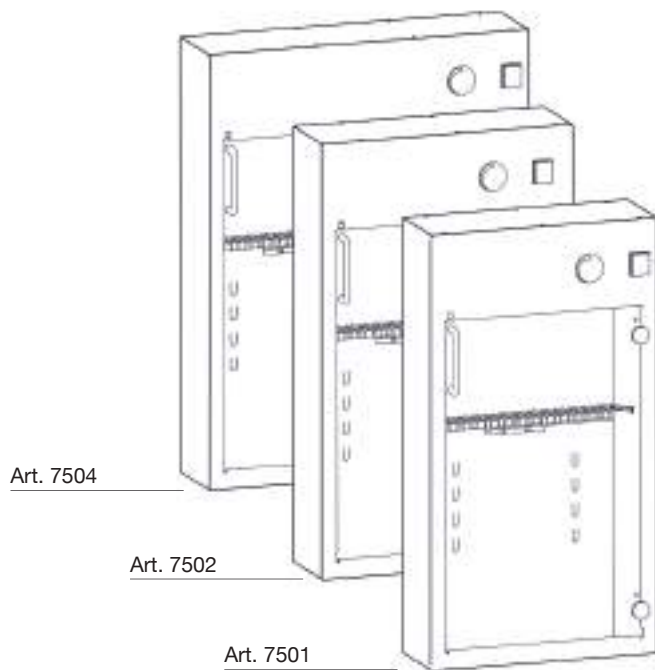
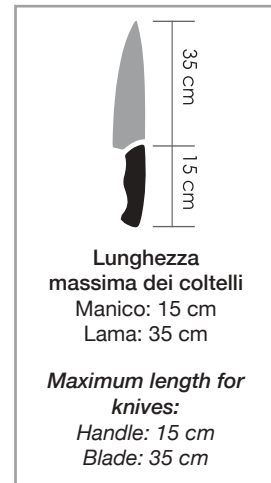

ARTICOLO / ARTICLE	PREZZO / PRICE	COLTELLI / KNIVES	POTENZA / POWER	MAX DIM. CM
7501	€ 396,00	12	16W	36x13x67 h
7502	€ 433,00	14		40x13x67 h
7504	€ 480,00	20		51x13x67 h

TRAMOGGE IN ACCIAIO INOX AISI 304
AISI 304 STAINLESS STEEL WHEELED WASTE COLLECTORS

- Tramoggia in acciaio inox AISI 304, finitura spazzolata
- Fondo stampato a tenuta stagna, privo di spigoli
- Coperchio con apertura manuale
- Divisione del coperchio 1/2+1/2
- Montata su ruote

- *AISI 304 stainless steel waste container, brushed finish*
- *Watertight pressed bottom with no sharp edges*
- *Manual opening lid: 1/2+1/2*
- *Wheel-mounted*



Fondo
a tenuta stagna
Watertight
pressed bottom



Art. 2101TR



ARTICOLO / ARTICLE	PREZZO / PRICE	CAPACITÀ LT / LT CAPACITY	MAX DIM. CM
2100TR	€ 658,00	115	40x61x73 h
2101TR	€ 658,00	125	40x61x79 h
2102TR	€ 704,00	135	40x70x73 h
2103TR	€ 704,00	150	40x70x79 h

VASCHE CARRELLATE IN ACCIAIO INOX AISI 304
 AISI 304 STAINLESS STEEL TROLLEY WELLS

- Vasca carrellata in acciaio inox AISI 304, con rubinetto, finitura spazzolata
- Fondo stampato a tenuta stagna, privo di spigoli
- Montata su ruote
- *AISI 304 stainless steel trolley well with tap, brushed finish*
- *Watertight pressed bottom with no sharp edges*
- *Wheel-mounted*



Fondo
a tenuta stagna
Watertight
pressed bottom



Art. 2112VC



Particolare rubinetto
 Tap detail

ARTICOLO / ARTICLE	PREZZO / PRICE	CM PROF VASCA / WELL DEPTH	CAPACITÀ LT / LT CAPACITY	MAX DIM. CM
2112VC	€ 517,00	30	90	60x50x60 h
2113VC	€ 968,00	44	190	80x60x75 h

MOBILETTI SCALDAPIATTI PLATE WARMER CABINETS

- Struttura in acciaio inox.
- Pareti a porte coibentate per una minore dispersione del calore.
- Termostato regolabile 0-90°C.
- Resistenza ad "L" per una migliore performance di riscaldamento.
- Alimentazione: 230V, 1N, 50/60 Hz.

- *Stainless steel structure.*
- *Insulated doors to reduce heat dissipation.*
- *Adjustable thermostat 0-90°C.*
- *"L" shaped heating element for better heating performance.*
- *Power supply: 230V, 1N, 50/60 Hz.*

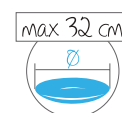
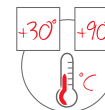

Art. 9660G



Art. 9630G

Art. 96120G



ARTICOLO / ARTICLE	PREZZO / PRICE	PORTATA PIATTI / PLATE CAP	Ø MAX CM PIATTI / DISHES	PORTE / DOORS	GRIGLIE / SHELVES	POTENZA / POWER	MAX DIM. CM
9630G	€ 898,00	30	32	1	3	400W	40x41x55 h
9660G	€ 982,00	60				750W	40x41x90 h
96120G	€ 1.365,00	120		2		1500W	70x41x90 h

OPTIONAL	PREZZO / PRICE	DESCRIZIONE / DESCRIPTION	PER / FOR
RF	€ 48,00	Ruote piroettanti di cui 2 con freno Swivel castors, 2 with brake	Tutti gli articoli tranne art. 9630 All Articles except art. 9630

COLONNE PORTAPIATTI
WHEELED PLATE STACKERS

- Struttura in acciaio verniciato nero a polveri epossidiche
- Griglie in acciaio plastificato rilsan bianco
- Maniglia di spinta
- Ruote piroettanti ø cm 12,5, di cui 2 con freno

- *Black epoxy powder painted steel construction*
- *White rilsan plastic coated steel plate support*
- *Pushing handles*
- *Swivel castors, ø 12.5 cm, 2 with brake*



Art. 3011

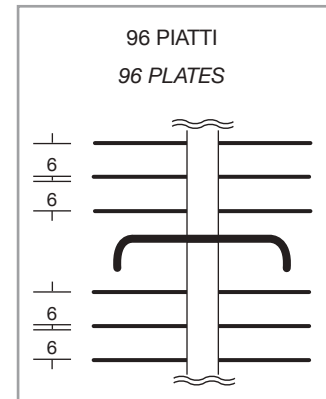

ARTICOLO / ARTICLE	PREZZO / PRICE	PIATTI / PLATES	Ø CM PIATTI / PLATES	MAX DIM. CM
3010	€ 738,00	96	18÷24	77x77x180 h
3011	€ 770,00			
3020	€ 361,00	48	24÷31	77x77x95 h
3021	€ 377,00			

OPTIONAL	PREZZO / PRICE	DESCRIZIONE / DESCRIPTION	PER / FOR
A0250	€ 202,00	Rivestimento in PVC con cerniere <i>PVC cover with zipper</i>	3010 - 3011
A0252	€ 211,00	Rivestimento in PVC con cerniere <i>PVC cover with zipper</i>	3020 - 3021



VETRINE CALDE HEATED DISPLAY CASES

- Struttura esterna ed interna interamente in lamiera di acciaio inox, isolamento con iniezione di poliuretano espanso ad alta densità
- Porte in vetro temperato su entrambi i lati, apribili a 180°, con spigoli arrotondati e guarnizioni in PVC nella battuta, sfilabili per permettere una facile pulizia
- Cerniere con chiusura a scatto
- Maniglie laterali di spinta in tubo di acciaio inox con supporti in PVC
- Riscaldamento ventilato, potenza 2000W
- Pannello comandi con termostato-termometro digitale e interruttore di accensione
- Tensione rete 230 Volt monofase-50 Hz, 60 Hz a richiesta
- Cavo di alimentazione spiralato, lunghezza 3 metri
- Ruote piroettanti ø cm 12,5, di cui 2 con freno

DOTAZIONE INTERNA:

- Cremagliera da 27 guide con passo 4 cm per griglie da 65x65 cm (standard fornito con 15 griglie passo 8 cm)

OPPURE:

- Colonna portapiatti (capacità 88 piatti)

- Fully stainless steel sheet construction, insulated with injected high density expanded polyurethane
- 180° opening tempered glass doors on 2 sides with no sharp edges and removable PVC door seals for easy cleaning
- Snap-closing hinges
- Stainless steel tube side pushing handles with PVC brackets
- Ventilated heating, power 2000W
- Control panel with digital thermostat-thermometer and ON/OFF switch with warning light
- Mains supply: 230V, 50Hz (60 Hz upon request), single-phase
- 3-mt long coiled power cable
- Swivel castors ø 12.5 cm, 2 with brake

INTERNAL OPTIONS:

- Rack with 27 grills spaced 4 cm for 65x65 cm grills (standard model supplied with 15 grills spaced 8 cm)

OR:

- Plate holder (88 plates capacity)

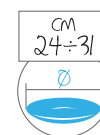
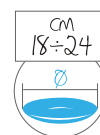
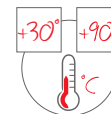

Art. 3360GS



Art. 3360PS-88

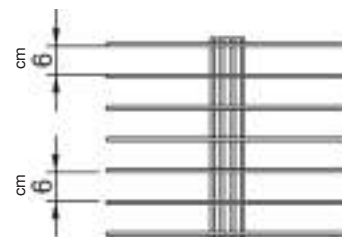

88 piatti
88 plates

ARTICOLO / ARTICLE	PREZZO / PRICE	Ø CM PIATTI / PLATES	POTENZA / POWER	MAX DIM. CM
3360GS	€ 3.547,00	15 Griglie / Grills	2000W	83x77x190 h

ARTICOLO / ARTICLE	PREZZO / PRICE	Ø CM PIATTI / DISHES	SUPPORTI / SUPPORTS	NR. PIATTI / DISHES	POTENZA / POWER	MAX DIM. CM
3360PS-88	€ 3.395,00	18÷24	Colonna Column	88	2000W	88x77x190 h
3361PS-88	€ 3.424,00	24÷31		88		

OPTIONAL	PREZZO / PRICE	DESCRIZIONE / DESCRIPTION
A0054	€ 41,00	65x65 cm Griglia / Grill

- Struttura esterna ed interna interamente in lamiera di acciaio inox, isolamento con iniezione di poliuretano espanso ad alta densità
- Base a forma di vasca a tenuta stagna interamente in acciaio inox, con foro per lo scarico della condensa
- Porte in vetro temperato su entrambi i lati, apribili a 180°, con spigoli arrotondati e guarnizioni in PVC nella battuta, sfilabili per permettere una facile pulizia
- Cerniere con chiusura a scatto
- Maniglie laterali di spinta in tubo di acciaio inox con supporti in PVC
- Pannello comandi con termostato-termometro digitale e interruttore di accensione con spia luminosa
- Tensione rete 230 Volt monofase-50 Hz, 60 Hz a richiesta
- Refrigerazione statica +4°C +10°C
- Cavo di alimentazione spiralato, lunghezza 3 metri
- Ruote piroettanti ø cm 12,5, di cui 2 con freno

DOTAZIONE INTERNA:

- Cremagliera da 27 guide con passo 4 cm per griglie da 65x65 cm (standard fornito con 15 griglie passo 8 cm)

OPPURE:

- Colonna portapiatti (capacità 88 piatti)

- Fully stainless steel sheet construction, insulated with injected high density expanded polyurethane
- Stainless steel watertight deep base with drain hole
- 180° opening tempered glass doors on 2 sides with no sharp edges and removable PVC door seals for easy cleaning
- Snap-closing hinges
- Stainless steel tube side pushing handles with PVC brackets
- Control panel with digital thermostat-thermometer and ON/OFF switch with warning light
- Mains supply: 230V, 50 Hz (60 Hz upon request), single-phase
- Static refrigeration +4°C +10°C
- 3-mt long coiled power cable
- Swivel castors ø 12.5 cm, 2 with brake

INTERNAL OPTIONS:

- Rack with 27 grills spaced 4 cm for 65x65 cm grills (standard model supplied with 15 grills spaced 8 cm)
- Plate holder (88 plates capacity)

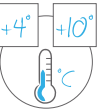

Art. 3370GS



Art. 3370PS-88

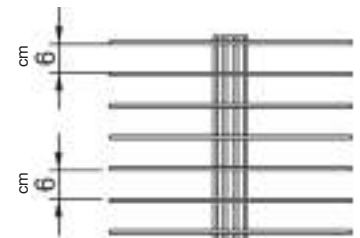

88 piatti
88 plates

ARTICOLO / ARTICLE	PREZZO / PRICE	Ø CM PIATTI / DISHES	POTENZA / POWER	MAX DIM. CM
3370GS	€ 4.828,00	15 Griglie / Grills	1200W	83x77x190 h

ARTICOLO / ARTICLE	PREZZO / PRICE	Ø CM PIATTI / DISHES	SUPPORTI / SUPPORTS	NR. PIATTI / DISHES	POTENZA / POWER	MAX DIM. CM
3370PS-88	€ 4.763,00	18÷24	Colonna Column	88	1200W	88x77x190 h
3371PS-88	€ 4.794,00	24÷31		88		

OPTIONAL	PREZZO / PRICE	DESCRIZIONE / DESCRIPTION
A0055	€ 41,00	65x65 cm Griglia / Grill



	GUERIDON <i>GUÉRIDON</i>	PAG. 144
	CARRELLI DI SERVIZIO IN LEGNO <i>WOODEN SERVICE TROLLEYS</i>	PAG. 145
	CARRELLI DI SERVIZIO IN LEGNO "MODERN-STYLE" <i>"MODERN STYLE" WOODEN SERVICE TROLLEYS</i>	PAG. 146
	CARRELLI FLAMBÉ <i>FLAMBÉ TROLLEYS</i>	PAG. 150
	MOBILI DI SERVIZIO <i>WAITER'S STATIONS</i>	PAG. 151
	CARRELLI DI SERVIZIO IN ACCIAIO CON RIPIANI IN LEGNO <i>STAINLESS STEEL SERVICE TROLLEYS WITH MELAMINE-FACED SHELVES</i>	PAG. 154

GUÉRIDON GUÉRIDON

- Struttura in legno massello
- Piani in nobilitato
- Piano superiore con paracolpi perimetrale in gomma
- Ruote piroettanti ø cm 9,5

- *Solid wood frame*
- *Melamine-faced shelves*
- *Top shelf fitted with all round rubber bumper*
- *Swivel castors, ø 9.5 cm*



Art. 1095S



Art. 1095SW



Art. 1095SN

ARTICOLO / ARTICLE	PREZZO / PRICE	COLORE / COLOUR	PIANI / SHELVES	MAX DIM. CM
1095S	€ 315,00	Rovere / Oak	2	71x46x78 h
1095SW	€ 315,00	Wengé / Wengé		
1095SN	€ 315,00	Nero / Black		

OPTIONAL	PREZZO / PRICE	📷	DESCRIZIONE / DESCRIPTION	PER / FOR
F	€ 13,00	1	Set 2 ruote con freno Set with 2 braked castors	Tutti gli articoli All Articles
E	€ 200,00	2	Set 4 ruote elastiche, di cui 2 con freno Set with 4 resilient castors, 2 with brake	



CARRELLI DI SERVIZIO LEGNO WOODEN SERVICE TROLLEYS

- Struttura in legno massello
- Piani in nobilitato
- Maniglia di spinta in tubolare cromato
- Ringhiere sui piani inferiori
- Ruote piroettanti ø cm 12,5

- *Solid wood frame*
- *Melamine-faced shelves*
- *Chrome plated pushing handle*
- *Rails on lower shelves*
- *Swivel castors, ø 12.5 cm*

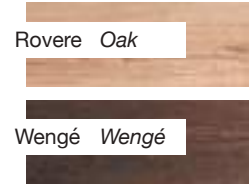

Art. 6061-F



Art. 6063W-F

ARTICOLO / ARTICLE	PREZZO / PRICE	COLORE / COLOUR	PIANI / SHELVES	DIM. PIANO / SHELF CM	MAX DIM. CM
6061	€ 646,00	Rovere / Oak	2	94,5x55	110x56x81 h
6061W	€ 646,00	Wengé / Wengé			
6063	€ 835,00	Rovere / Oak	3		110x56x87 h
6063W	€ 835,00	Wengé / Wengé			

OPTIONAL	PREZZO / PRICE	IMMAGINE	DESCRIZIONE / DESCRIPTION	PER / FOR
F	€ 32,00		Set 2 ruote con freno Set with 2 braked castors	Tutti gli articoli All Articles
E	€ 200,00		Set 4 ruote elastiche, di cui 2 con freno Set with 4 resilient castors, 2 with brake	

CARRELLI DI SERVIZIO LEGNO CON CUPOLA WOODEN SERVICE TROLLEYS WITH DOME

- Struttura in legno massello
- Piani in nobilitato
- Maniglia di spinta in tubolare cromato
- Cupola semicilindrica in plexiglass apribile su due lati
- Ringhiere sui piani inferiori
- Ruote piroettanti ø cm 12,5

- *Solid wood structure*
- *Melamine-faced shelves*
- *Chromed tubular push handle*
- *Semi-cylindrical plexiglass dome that opens on two sides*
- *Railings on lower floors*
- *Swivel castors ø 12.5 cm*

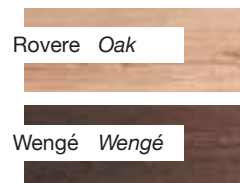

Art. 6061C-F



Art. 6063CW-F

ARTICOLO / ARTICLE	PREZZO / PRICE	COLORE / COLOUR	PIANI / SHELVES	DIM. PIANO / SHELF CM	MAX DIM. CM
6061C	€ 1.000,00	Rovere / Oak	2	107x55x82 h	110x56x107 h
6061CW	€ 1.000,00	Wengé / Wengé			
6063C	€ 1.187,00	Rovere / Oak	3	107x55x82 h	110x56x113 h
6063CW	€ 1.187,00	Wengé / Wengé			

OPTIONAL	PREZZO / PRICE	DESCRIZIONE / DESCRIPTION	PER / FOR
F	€ 32,00	Set 2 ruote con freno Set with 2 braked castors	Tutti gli articoli All Articles
E	€ 200,00	Set 4 ruote elastiche, di cui 2 con freno Set with 4 resilient castors, 2 with brake	

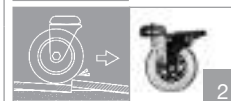

OPTIONAL	PREZZO / PRICE	DESCRIZIONE / DESCRIPTION	PER / FOR
A0096	€ 91,00	Cassetto portaposate estraibile in PVC Removable PVC cutlery drawer	Tutti gli articoli All Articles
A0036	€ 83,00	Supporto portapiatti estraibile tinto Rovere Removable oak-stained plate holder	6061C 6063C
A0036W	€ 83,00	Supporto portapiatti estraibile tinto Wengé Wengé stained extractable plate holder	6061CW 6063CW



CARRELLI DI SERVIZIO LEGNO - PIANI CM 70X45
 MODERN-STYLE WOODEN SERVICE TROLLEYS - 70X45 CM SHELVES

- Gambe in legno massello a sezione quadrata
 - Ripiani in nobilitato
 - Portapiatti estraibile (a seconda del modello)
 - Ruote piroettanti ø cm 9,5, di cui 2 con freno
- *Square section solid wood legs*
 - *Melamine-faced shelves*
 - *Sliding plate support (depending on the model)*
 - *Swivel castors, ø 9.5 cm, 2 with brake*

Grigio Granito
 Granite Grey

Magnolia
 Magnolia White

Grigio Zonda
 Zonda Grey



Art. 6830G



Art. 6832M

ARTICOLO / ARTICLE	PREZZO / PRICE	LACCATURA / LACQUER	ESTRAIBILE / SLIDING SUPPORT	MAX DIM. CM
6830G	€ 621,00	Grigio Granito / Granite Grey	-	70x45x84 h
6830M	€ 621,00	Magnolia / Magnolia White		
6830Z	€ 621,00	Grigio Zonda / Zonda Grey		
6832G	€ 741,00	Grigio Granito / Granite Grey	Sì Yes	
6832M	€ 741,00	Magnolia / Magnolia White		
6832Z	€ 741,00	Grigio Zonda / Zonda Grey		

OPTIONAL	PREZZO / PRICE	DESCRIZIONE / DESCRIPTION	PER / FOR
E	€ 200,00	Set 4 ruote elastiche, di cui 2 con freno Set with 4 resilient castors, 2 with brake	Tutti gli articoli All Articles

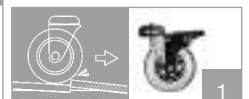

CARRELLI DI SERVIZIO LEGNO - PIANI CM 100X45
MODERN-STYLE WOODEN SERVICE TROLLEYS - 100X45 CM SHELVES

- Gambe in legno massello a sezione quadrata
- Ripiani in nobilitato
- Portapiatti estraibile (a seconda del modello)
- Ruote piroettanti ø cm 9,5, di cui 2 con freno

- *Square section solid wood legs*
- *Melamine-faced shelves*
- *Sliding plate support (depending on the model)*
- *Swivel castors, ø 9.5 cm, 2 with brake*

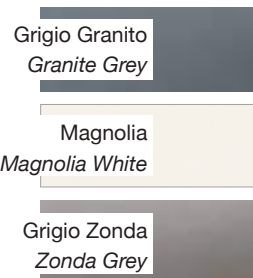

Art. 6842Z



Chiusura soft-close per gli articoli con il portapiatti
Softclose closing for items with plate support



Art. 6840G

ARTICOLO / ARTICLE	PREZZO / PRICE	LACCATURA / LACQUER	ESTRAIBILE / SLIDING SUPPORT	MAX DIM. CM
6840G	€ 659,00	Grigio Granito / Granite Grey	-	100x45x84 h
6840M	€ 659,00	Magnolia / Magnolia White		
6840Z	€ 659,00	Grigio Zonda / Zonda Grey		
6842G	€ 778,00	Grigio Granito / Granite Grey	Sì Yes	
6842M	€ 778,00	Magnolia / Magnolia White		
6842Z	€ 778,00	Grigio Zonda / Zonda Grey		

OPTIONAL	PREZZO / PRICE	DESCRIZIONE / DESCRIPTION	PER / FOR
E	€ 200,00	Set 4 ruote elastiche, di cui 2 con freno Set with 4 resilient castors, 2 with brake	Tutti gli articoli All Articles

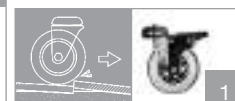

CARRELLI DI SERVIZIO LEGNO - PIANI CM 100X56
 MODERN-STYLE WOODEN SERVICE TROLLEYS - 100X56 CM SHELVES

- Gambe in legno massello a sezione quadrata
 - Ripiani in nobilitato
 - Portapiatti estraibile (a seconda del modello)
 - Piano superiore con cupola semicilindrica in plexiglass apribile su due lati (a seconda del modello)
 - Ruote piroettanti ø cm 9,5, di cui 2 con freno
- Square section solid wood legs
 - Melamine-faced shelves
 - Sliding plate support (depending on the model)
 - Top shelf with plexiglass semi-cylindrical dome opening on both sides (depending on the model)
 - Swivel castors, ø 9.5 cm, 2 with brake

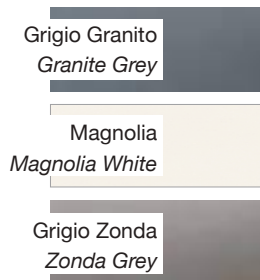

Art. 6854G



Art. 6850Z

ARTICOLO / ARTICLE	PREZZO / PRICE	LACCATURA / LACQUER	ESTRAIBILE / SLIDING SUPPORT	CUPOLA / DOME	MAX DIM. CM
6850G	€ 693,00	Grigio Granito / Granite Grey	-	-	100x56x84 h
6850M	€ 693,00	Magnolia / Magnolia White			
6850Z	€ 693,00	Grigio Zonda / Zonda Grey			
6852G	€ 809,00	Grigio Granito / Granite Grey	Sì Yes	-	100x56x84 h
6852M	€ 809,00	Magnolia / Magnolia White			
6852Z	€ 809,00	Grigio Zonda / Zonda Grey			
6854G	€ 1.251,00	Grigio Granito / Granite Grey	Sì Yes	Sì Yes	100x56x110 h
6854M	€ 1.251,00	Magnolia / Magnolia White			
6854Z	€ 1.251,00	Grigio Zonda / Zonda Grey			

OPTIONAL	PREZZO / PRICE	DESCRIZIONE / DESCRIPTION	PER / FOR
E	€ 200,00	Set 4 ruote elastiche, di cui 2 con freno Set with 4 resilient castors, 2 with brake	Tutti gli articoli All Articles

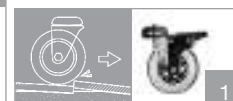

FLAMBÉ TROLLEYS

FLAMBÉ

- Struttura e pannelli in nobilitato
- Fornelli inox con termocoppia di sicurezza a norma CE
- Ribaltina laterale
- Portabottiglie in acciaio cromato
- Cassetto portaposate
- Sportello vano bombola
- Ruote piroettanti ø cm 12,5, di cui 2 con freno

- *Melamine-faced frame and panels*
- *Stainless steel hob with flame failure safety device compliant with EC standards*
- *Side condiment folding shelf*
- *Chrome-plated steel bottle holder*
- *Cutlery drawer*
- *LPG cylinder housing door*
- *Swivel castors ø 12.5 cm, 2 with brake*

N.B.: bombola GPL e regolatore di pressione esclusi
Note: LPG cylinder and gas pressure regulator not included

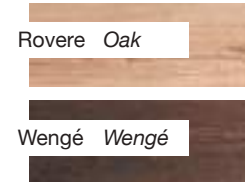

Art. 1160W



Art. 1160D



Art. 1160S

ARTICOLO / ARTICLE	PREZZO / PRICE	COLORE / COLOUR	FUOCHI / BURNERS	MAX DIM. CM (APERTO / OPEN)	MAX DIM. CM (CHIUSO / CLOSED)
1160S	€ 1.271,00	Rovere / Oak	1 singolo <i>single</i>	123x50x87 h	95x50x87 h
1160SW	€ 1.271,00	Wengé / Wengé			
1160D	€ 1.588,00	Rovere / Oak	2 separati <i>double</i>		
1160DW	€ 1.588,00	Wengé / Wengé			
1160	€ 1.576,00	Rovere / Oak	2 uniti <i>twin</i>		
1160W	€ 1.576,00	Wengé / Wengé			

ACCESSORI / ACCESSORIES	PREZZO / PRICE	DESCRIZIONE / DESCRIPTION	PER / FOR
A80	€ 71,00	Regolatore gas (GPL 30 mbar), singolo, completo di raccordi <i>Gas pressure regulator (LPG 30 mbar), single, c/w fittings</i>	1160S 1160SW 1160 1160W
A82	€ 168,00	Regolatore gas (GPL 30 mbar), doppio, completo di raccordi <i>Gas pressure regulator (LPG 30 mbar), double, c/w fittings</i>	1160D 1160DW
A81	€ 71,00	Regolatore gas (GPL 50 mbar), singolo, completo di raccordi <i>Gas pressure regulator (LPG 50 mbar), single, c/w fittings</i>	1160S 1160SW 1160 1160W
A83	€ 168,00	Regolatore gas (GPL 50 mbar), doppio, completo di raccordi <i>Gas pressure regulator (LPG 50 mbar), double, c/w fittings</i>	1160D 1160DW



- Struttura e pannelli in nobilitato
 - Alzatina con due mensole
 - Cassetti portaposate con separatori, montati su guide
 - Ogni vano ha un ripiano regolabile interno
 - Ruote ø cm 5
- *Melamine-faced frame and panels*
 - *2 Upper shelves*
 - *Cutlery drawers on runners, with dividers*
 - *Each compartment has a inner adjustable shelf*
 - *Castors, ø 5 cm*

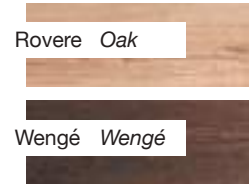

Laccatura opaca a scelta.
Comunicare il codice RAL richiesto.
*Matt lacquering.
Please indicate the RAL code of the colour.*



Art. 1600



Art. 1600W



Cassetto portaposate
Cutlery drawer

ARTICOLO / ARTICLE	PREZZO / PRICE	FINITURA / FINISH	DESCRIZIONE / DESCRIPTION	RIPIANO INTERMEDIO / INTERNAL SHELVES	MAX DIM. CM (CHIUSO / CLOSED)
1600	€ 1.015,00	Rovere / Oak	2 sportelli 2 Doors	2	94x48x145 h
1600W	€ 1.036,00	Wengé / Wengé			
1600RAL	€ 1.711,00	RAL			
1605	€ 1.522,00	Rovere / Oak	2 tramogge 2 Large flap-opening compartments	-	
1605W	€ 1.539,00	Wengé / Wengé			
1605RAL	€ 2.215,00	RAL			
1606	€ 1.268,00	Rovere / Oak	1 sportello + 1 tramoggia 1 Door + 1 flap-opening compartment	1	
1606W	€ 1.289,00	Wengé / Wengé			
1606RAL	€ 1.962,00	RAL			
1607	€ 972,00	Rovere / Oak	1 sportello + 1 vano a giorno 1 Door + 1 open unit	2	
1607W	€ 990,00	Wengé / Wengé			
1607RAL	€ 1.666,00	RAL			

MOBILI DI SERVIZIO HIGH SINGLE WAITER'S STATIONS

- Struttura e pannelli in nobilitato
 - Alzatina con due mensole
 - Cassetto portaposate con separatori, montato su guide
 - Vano dotato di ripiano regolabile interno
 - Ruote ø cm 5
- *Melamine-faced frame and panels*
 - *2 Upper shelves*
 - *Cutlery drawer on runners, with dividers*
 - *Compartment with inner adjustable shelf*
 - *Castors, ø 5 cm*

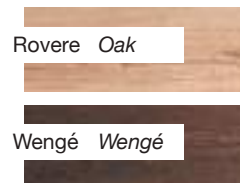

Laccatura opaca a scelta.
Comunicare il codice RAL richiesto.
Matt lacquering.
Please indicate the RAL code of the colour.



Art. 1610



Art. 1610W



Cassetto portaposate
Cutlery drawer

ARTICOLO / ARTICLE	PREZZO / PRICE	FINITURA / FINISH	DESCRIZIONE / DESCRIPTION	RIPIANO INTERMEDIO / INTERNAL SHELVES	MAX DIM. CM (CHIUSO / CLOSED)
1610	€ 756,00	Rovere / Oak	1 sportello <i>1 Door</i>	1	48x48x145 h
1610W	€ 776,00	Wengé / Wengé			
1610RAL	€ 1.384,00	RAL			
1615	€ 1.008,00	Rovere / Oak	1 tramoggia <i>1 flap-opening compartment</i>	-	
1615W	€ 1.028,00	Wengé / Wengé			
1615RAL	€ 1.635,00	RAL			
1616	€ 712,00	Rovere / Oak	1 vano a giorno <i>1 Open unit</i>	1	
1616W	€ 733,00	Wengé / Wengé			
1616RAL	€ 1.338,00	RAL			

- Struttura e pannelli in nobilitato
- Cassetti portaposate con separatori, montati su guide
- Ogni vano è dotato di ripiano regolabile interno
- Ruote ø cm 5

- *Melamine-faced frame and panels*
- *Cutlery drawers on runners, with dividers*
- *Each compartment has a inner adjustable shelf*
- *Castors, ø 5 cm*

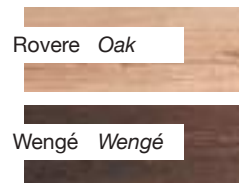

Laccatura opaca a scelta.
Comunicare il codice RAL richiesto.

*Matt lacquering.
Please indicate the RAL code of the colour.*



Art. 1620



Art. 1620W



Cassetto portaposate
Cutlery drawer

ARTICOLO / ARTICLE	PREZZO / PRICE	FINITURA / FINISH	DESCRIZIONE / DESCRIPTION	RIPIANO INTERMEDIO / INTERNAL SHELVES	MAX DIM. CM (CHIUSO / CLOSED)
1620	€ 913,00	Rovere / Oak	2 sportelli 2 Doors	2	94x48x98 h
1620W	€ 935,00	Wengé / Wengé			
1620RAL	€ 1.558,00	RAL			
1625	€ 1.419,00	Rovere / Oak	2 tramogge 2 Large flap-opening compartments	-	
1625W	€ 1.438,00	Wengé / Wengé			
1625RAL	€ 2.062,00	RAL			
1626	€ 1.166,00	Rovere / Oak	1 sportello + 1 tramoggia 1 Door + 1 flap-opening compartment	1	
1626W	€ 1.186,00	Wengé / Wengé			
1626RAL	€ 1.811,00	RAL			
1627	€ 872,00	Rovere / Oak	1 sportello + 1 vano a giorno 1 Door + 1 open unit	2	
1627W	€ 890,00	Wengé / Wengé			
1627RAL	€ 1.513,00	RAL			

CARRELLI DI SERVIZIO IN ACCIAIO - PIANI IN NOBILITATO STAINLESS STEEL SERVICE TROLLEYS - MELAMINE-FACED SHELVES

- Struttura in tubo quadro di acciaio inox cm 2x2, finitura spazzolata
- Piani in nobilitato con bordi in tubo di acciaio inox spazzolato
- Paracolpi in gomma grigia
- Ruote piroettanti ø cm 12,5

- *Stainless steel 2x2 cm square tube frame, brushed finish*
- *Melamine-faced shelves with brushed stainless steel tubular edges*
- *Grey rubber ring buffers*
- *Swivel castors, ø 12.5 cm*

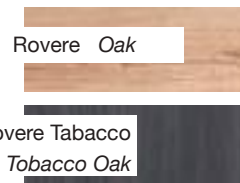

Art. 4690.2T



Art. 4690.3

ARTICOLO / ARTICLE	PREZZO / PRICE	FINITURA / FINISH	RIPIANI / SHELVES	DIM. PIANO / SHELF CM	MAX DIM. CM
4650.2	€ 321,00	Rovere / Oak	2	50x45	61x52x95 h
4650.2T	€ 346,00	Tabacco Rovere / Tobacco Oak			
4650.3	€ 409,00	Rovere / Oak	3		61x52x103 h
4650.3T	€ 442,00	Tabacco Rovere / Tobacco Oak			
4650.4	€ 504,00	Rovere / Oak	4	61x52x137 h	
4650.4T	€ 543,00	Tabacco Rovere / Tobacco Oak			
4670.2	€ 335,00	Rovere / Oak	2	70x45	61x52x95 h
4670.2T	€ 361,00	Tabacco Rovere / Tobacco Oak			
4670.3	€ 428,00	Rovere / Oak	3		61x52x103 h
4670.3T	€ 462,00	Tabacco Rovere / Tobacco Oak			
4670.4	€ 532,00	Rovere / Oak	4	61x52x137 h	
4670.4T	€ 572,00	Tabacco Rovere / Tobacco Oak			
4690.2	€ 360,00	Rovere / Oak	2	90x45	61x52x95 h
4690.2T	€ 389,00	Tabacco Rovere / Tobacco Oak			
4690.3	€ 468,00	Rovere / Oak	3		61x52x103 h
4690.3T	€ 505,00	Tabacco Rovere / Tobacco Oak			
4690.4	€ 582,00	Rovere / Oak	4	61x52x137 h	
4690.4T	€ 627,00	Tabacco Rovere / Tobacco Oak			

OPTIONAL	PREZZO / PRICE	📷	DESCRIZIONE / DESCRIPTION	PER / FOR
F	€ 28,00	1	Set 2 ruote con freno Set with 2 braked castors	Tutti gli articoli All Articles
E	€ 200,00	2	Set 4 ruote elastiche, di cui 2 con freno Set with 4 resilient castors, 2 with brake	

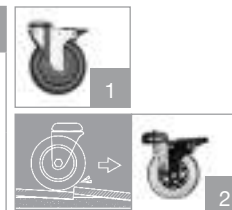





OPTIONAL	PREZZO / PRICE	📷	DESCRIZIONE / DESCRIPTION	PER / FOR
AB02	€ 84,00	3	Bacinella portarifiuti in PVC, cm 33x16x51 h PVC waste bin, 33x16x51 h cm	Tutti gli articoli All Articles
AB01	€ 42,00	4	Bacinella portarifiuti in PVC, cm 35x19x18 h PVC waste bin, 35x19x18 h cm	







	CARRELLI REFRIGERATI <i>REFRIGERATED TROLLEYS</i>	PAG. 158
	BUFFET REFRIGERATI <i>REFRIGERATED SELF-SERVICE BUFFET TROLLEYS</i>	PAG. 162
	BUFFET RISCALDATI <i>HEATED SELF-SERVICE BUFFET TROLLEYS</i>	PAG. 166
	BUFFET MISTI CALDO/FREDDO <i>MIXED HOT/COLD SELF-SERVICE BUFFET TROLLEYS</i>	PAG. 172
	DROP-IN REFRIGERATI E RISCALDATI <i>HEATED, REFRIGERATED DROP-IN</i>	PAG. 176

CARRELLI REFRIGERANTI REFRIGERATED TROLLEYS

- Cupola in plexiglass semicilindrica con apertura su due lati
- Pannelli e ripiano in legno multistrato
- Gambe in tubolare di acciaio inox AISI 304, finitura spazzolata
- Per la finitura colore NERO struttura in MDF idrorepellente protetto da trasparente
- Vasca in acciaio inox AISI 304 profonda cm 19, per bacinelle GN fino a cm 15 h (escluse)
- Foro sul fondo della vasca per lo scarico della condensa (con rubinetto a richiesta)
- **NB: per il pesce il rubinetto è obbligatorio**
- Pannello comandi con termostato-termometro digitale e interruttore di accensione con spia luminosa
- Tensione rete 230 Volt monofase 50 Hz, 60 Hz a richiesta
- Refrigerazione statica +4°C +10°C
- Ruote piroettanti ø cm 12,5 di cui 2 con freno

- *Plexiglass semi-cylindrical dome opening on both sides*
- *Plywood panels and shelf*
- *AISI 304 stainless steel legs, brushed finish*
- *For BLACK finish: structure in water-repellent MDF with transparent coating*
- *AISI 304 stainless steel 19 cm-deep well for up to 15 cm-deep GN pans (not included)*
- *Condensation drain hole at the base of the well (drain tap available on request)*
- **Note: the drain tap is necessary for fish displaying**
- *Control panel with digital thermostat-thermometer and ON/OFF switch with warning light*
- *Mains supply: 230V, 50 Hz (60 Hz upon request), single-phase*
- *Static refrigeration +4°C +10°C*
- *Swivel castors ø 12.5 cm, 2 with brake*

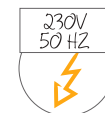
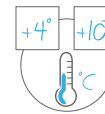

Laccatura opaca a scelta. Comunicare il codice RAL richiesto.
Matt lacquering. Please indicate the RAL code of the colour.



Optional bacinelle vedi pag. 78-79
Optional Gastronorms: see pp. 78-79

Art. 6930.3W + A20(x3)

NB: la singola mensola frontale viene montata dal lato opposto a quello dell'operatore salvo richiesta contraria

Note: when ordering one single front shelf, it is mounted on the opposite side to the operator one, unless otherwise specified.

ARTICOLO / ARTICLE	PREZZO / PRICE	FINITURA / FINISH	GN	POTENZA / POWER	MAX DIM. CM
6930.2R	€ 3.530,00	Rovere / Oak	2x1/1	190W	80x68x120 h
6930.2W	€ 3.530,00	Wengé / Wengé			
6930.2N	€ 4.014,00	Nero / Black			
6930.2RAL	€ 4.250,00	RAL			
6930.3R	€ 3.824,00	Rovere / Oak	3x1/1	350W	113x68x120 h
6930.3W	€ 3.824,00	Wengé / Wengé			
6930.3N	€ 4.349,00	Nero / Black			
6930.3RAL	€ 4.595,00	RAL			
6930.4R	€ 4.299,00	Rovere / Oak	4x1/1	450W	161x68x120 h
6930.4W	€ 4.299,00	Wengé / Wengé			
6930.4N	€ 4.487,00	Nero / Black			
6930.4RAL	€ 5.116,00	RAL			

ARTICOLO / ARTICLE	PREZZO / PRICE	FRONTALE / FRONT
A122R	€ 170,00	mensola frontale ribaltabile con scorri vassoi
A122W	€ 170,00	
A122N	€ 197,00	
A122RAL	€ 210,00	
A123R	€ 210,00	drop-down front shelf with tray slide
A123W	€ 210,00	
A123N	€ 245,00	
A123RAL	€ 280,00	
A124R	€ 258,00	
A124W	€ 258,00	
A124N	€ 299,00	
A124RAL	€ 337,00	

OPTIONAL	PREZZO / PRICE	DESCRIZIONE / DESCRIPTION	PER / FOR
A156	€ 48,00	Rubinetto di scarico (obbligatorio per il pesce) Drain tap (necessary for fish displaying)	Tutti gli articoli All Articles

ACCESSORI / ACCESSORIES	PREZZO / PRICE	DESCRIZIONE / DESCRIPTION	PER / FOR
A10	€ 39,00	1 Griglia liscia 1/1 GN 1/1 GN Flat	Tutti gli articoli All Articles
A20	€ 46,00	2 Griglia asolata 1/1 GN 1/1 GN Perforated	
LED	€ 319,00	- Illuminazione posta sulla cupola Well lighting	



GENERAL FEATURES

- Stainless overhead gantry
- Fixed plexiglass sneeze guard OR height-adjustable tempered glass sneeze guard
- Plywood panels, shelf (and doors in the cupboard version)
- AISI 304 stainless steel legs, brushed finish
- AISI 304 stainless steel 19 cm-deep well for up to 15 cm-deep GN pans (not included)
- Swivel castors \varnothing 12.5 cm, 2 with brake

CARATTERISTICHE GENERALI

- Castello superiore in acciaio inox
- Parafiato: fisso in plexiglass, mobile in vetro temperato
- Pannelli, ripiano e sportelli (nella versione armadiata) in legno multistrato
- Gambe in tubolare di acciaio inox AISI 304, finitura spazzolata
- Vasca in acciaio inox AISI 304 profonda 19 cm per bacinelle GN fino a 15 cm h (escluse)
- Ruote piroettanti \varnothing cm 12,5, di cui 2 con freno

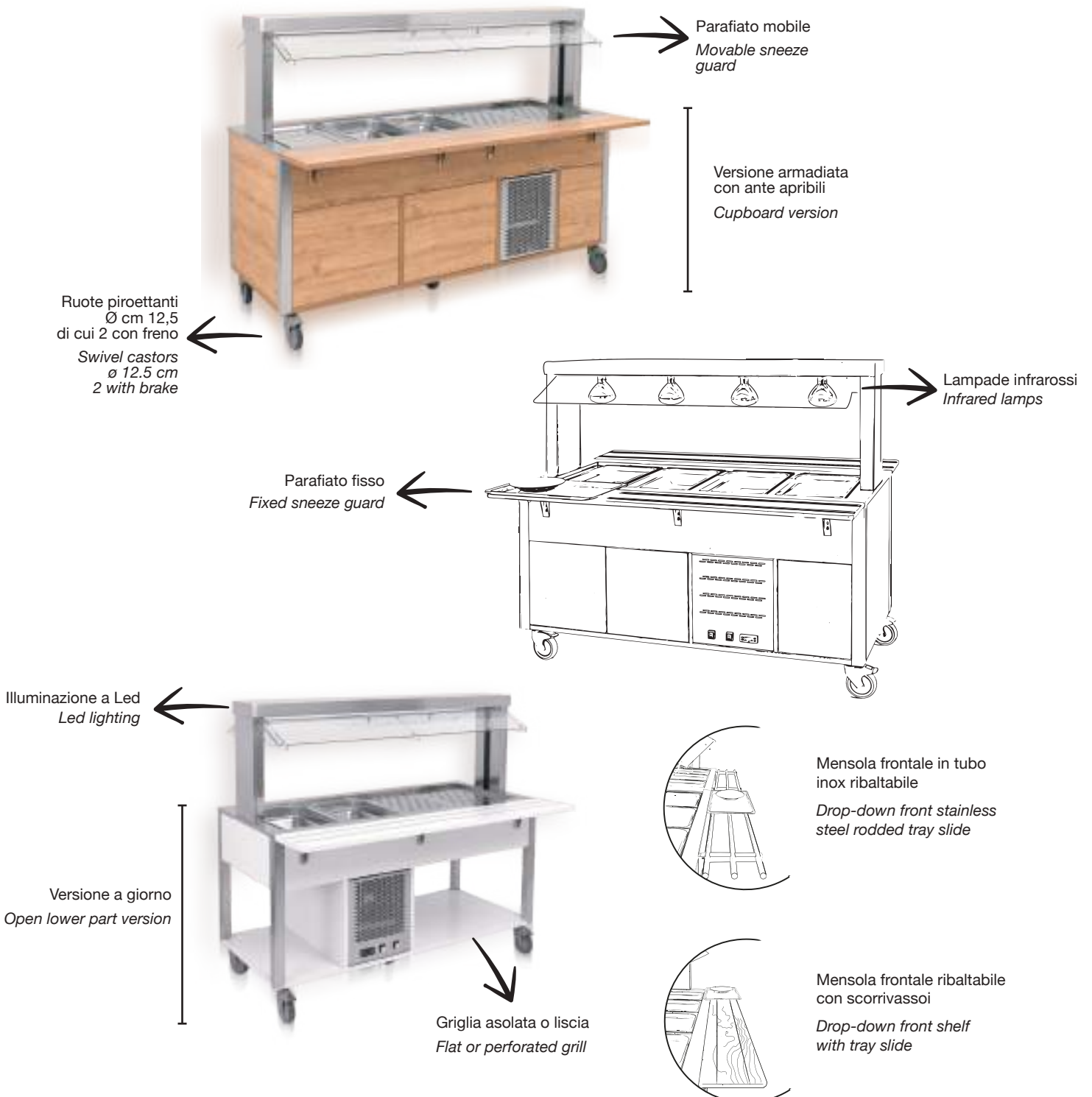

ISOLA BUFFET ARMADIATA CABINET BUFFET

- Castello superiore fisso in acciaio inox AISI 304 con parafiatto in plexiglass e lampade ad infrarossi riscaldanti (rosse o bianche a scelta).
 - Struttura, pannelli e sportelli in legno multistrato
 - Piano superiore riscaldato in acciaio
 - Pannello comandi con termostato-termometro digitale
 - Interruttori di accensione con spia luminosa
 - Tensione rete 230 Volt monofase 50/60 Hz
 - Temperatura di esercizio compresa fra 30°C e 90°C
 - Piedi regolabili e zoccolo in legno
 - Dimensioni cm 144 x 100 x h.138
 - Disponibile in diversi colori
- Fixed upper frame in AISI 304 stainless steel with plexiglass screen and infrared heating lamps (red or white to choose from).
 - Plywood structure, panels and doors
 - Heated upper shelf in steel
 - Control panel with digital thermostat-thermometer
 - Power switches with indicator light
 - Mains voltage 230 Volt single phase 50/60 Hz
 - Operating temperature between 30°C and 90°C
 - Adjustable feet and wooden plinth
 - Dimensions 144 x 100 x h.138 cm
 - Available in different colours

**NOVITÀ
NEW**

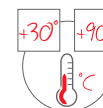

Art. 6970

Prezzo su richiesta

Price upon request



BUFFET FREDDI CON PARAFIATO FISSO - ILLUMINAZIONE A LED REFRIGERATED SELF-SERVICE BUFFET TROLLEYS - FIXED SNEEZE GUARD - LED LIGHTING

- Castello superiore in acciaio inox con illuminazione a led
- Parafiatto fisso in plexiglass
- Pannelli, ripiano (e sportelli nella versione armadiata) in legno multistrato
- Gambe in tubolare di acciaio inox AISI 304, finitura spazzolata
- Per la finitura colore NERO struttura in MDF idrorepellente protetto da trasparente
- Vasca in acciaio inox AISI 304 profonda cm 19 per bacinelle GN fino a cm 15 h (escluse)
- Foro sul fondo della vasca per lo scarico della condensa (con rubinetto a richiesta)
- **NB: per il pesce il rubinetto è obbligatorio**
- Pannello comandi con termostato-termometro digitale e interruttori di accensione con spia luminosa
- Tensione rete 230 Volt monofase-50 Hz, 60 Hz a richiesta
- Refrigerazione statica +4°C +10°C
- Cavo spiralato lunghezza 3mt., spina Schuko
- Ruote piroettanti ø cm 12,5, di cui 2 con freno

- *Stainless steel overhead gantry with led lighting*
- *Fixed plexiglass sneeze guard*
- *Plywood panels, shelf (and doors in the cupboard version)*
- *AISI 304 stainless steel legs, brushed finish*
- *For BLACK finish: structure in water-repellent MDF with transparent coating*
- *AISI 304 stainless steel 19 cm-deep well for up to 15 cm-deep GN pans (not included)*
- *Condensate drain at the base of the well (drain tap available on request)*
- **Note: the drain tap is necessary for fish displaying**
- *Control panel with digital thermostat-thermometer and ON/OFF switch with warning light*
- *Mains supply: 230V, 50 Hz (60 Hz upon request), single-phase*
- *Static refrigeration +4°C +10°C*
- *3m long coiled cable, Schuko plug*
- *Swivel castors ø 12.5 cm, 2 with brake*

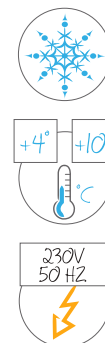

Laccatura opaca a scelta. Comunicare il codice RAL richiesto.
Matt lacquering.
Please indicate the RAL code of the colour.



Optional bacinelle vedi pag. 78-79
Optional Gastronorms: see pp. 78-79

Art. 6900.4-W + A124W(x2) + A156 + A20(x4)

VERSIONE A GIORNO OPEN LOWER PART VERSION

NB: la singola mensola frontale viene montata dal lato opposto a quello dell'operatore salvo richiesta contraria
Note: when ordering one single front shelf, it is mounted on the opposite side to the operator one, unless otherwise specified.

ARTICOLO / ARTICLE	PREZZO / PRICE	FINITURA / FINISH	GN	POTENZA / POWER	MAX DIM. CM	ARTICOLO / ARTICLE	PREZZO / PRICE	FRONTALE / FRONT	ARTICOLO / ARTICLE	PREZZO / PRICE	FRONTALE / FRONT
6900.2-R	€ 3.311,00	Rovere / Oak	2x1/1	200W	80x68x144 h	A120R	€ 170,00	mensola fissa con scorri vassoi fixed shelf with tray slide	A122R	€ 170,00	mensola frontale ribaltabile con scorri vassoi drop-down front shelf with tray slide
6900.2-W	€ 3.311,00	Wengé / Wengé				A120W	€ 170,00		A122W	€ 170,00	
6900.2-N	€ 3.807,00	Nero / Black				A120N	€ 197,00		A122N	€ 197,00	
6900.2-RAL	€ 4.040,00	RAL				A120RAL	€ 215,00		A122RAL	€ 210,00	
6900.3-R	€ 3.671,00	Rovere / Oak	3x1/1	360W	113x68x144 h	A120R	€ 170,00		A123R	€ 210,00	
6900.3-W	€ 3.671,00	Wengé / Wengé				A120W	€ 170,00		A123W	€ 210,00	
6900.3-N	€ 4.221,00	Nero / Black				A120N	€ 197,00		A123N	€ 245,00	
6900.3-RAL	€ 4.479,00	RAL				A120RAL	€ 215,00		A123RAL	€ 280,00	
6900.4-R	€ 4.232,00	Rovere / Oak	4x1/1	550W	161x68x144 h	A120R	€ 170,00		A124R	€ 258,00	
6900.4-W	€ 4.232,00	Wengé / Wengé				A120W	€ 170,00		A124W	€ 258,00	
6900.4-N	€ 4.867,00	Nero / Black				A120N	€ 197,00		A124N	€ 299,00	
6900.4-RAL	€ 5.162,00	RAL				A120RAL	€ 215,00		A124RAL	€ 337,00	
6900.5-R	€ 4.677,00	Rovere / Oak	5x1/1	480W	193x68x144 h	A120R	€ 170,00	A125R	€ 337,00		
6900.5-W	€ 4.677,00	Wengé / Wengé				A120W	€ 170,00	A125W	€ 337,00		
6900.5-N	€ 5.378,00	Nero / Black				A120N	€ 197,00	A125N	€ 393,00		
6900.5-RAL	€ 5.706,00	RAL				A120RAL	€ 215,00	A125RAL	€ 474,00		
6900.6-R	€ 5.121,00	Rovere / Oak	6x1/1	690W	226x68x144 h	A120R	€ 170,00	A126R	€ 384,00		
6900.6-W	€ 5.121,00	Wengé / Wengé				A120W	€ 170,00	A126W	€ 384,00		
6900.6-N	€ 5.889,00	Nero / Black				A120N	€ 197,00	A126N	€ 447,00		
6900.6-RAL	€ 6.247,00	RAL				A120RAL	€ 215,00	A126RAL	€ 578,00		

BUFFET FREDDI CON PARAFIATO FISSO - ILLUMINAZIONE A LED
REFRIGERATED SELF-SERVICE BUFFET TROLLEYS - FIXED SNEEZE GUARD - LED LIGHTING



Art. 6900CPB.4-N + A124N(x2) + A10(x3) + A20(x1)



VERSIONE ARMADIATA: completo di schienale, pannelli laterali e sportelli
CUPBOARD VERSION: with back panel, side panels and doors

NB: la singola mensola frontale viene montata dal lato opposto a quello dell'operatore salvo richiesta contraria
Note: when ordering one single front shelf, it is mounted on the opposite side to the operator one, unless otherwise specified.

ARTICOLO / ARTICLE	PREZZO / PRICE	FINITURA / FINISH	GN	POTENZA / POWER	MAX DIM. CM	ARTICOLO / ARTICLE	PREZZO / PRICE	FRONTALE / FRONT	ARTICOLO / ARTICLE	PREZZO / PRICE	FRONTALE / FRONT
6900CPB.2-R	€ 4.138,00	Rovere / Oak	2x1/1	200W	80x68x144 h	A120R	€ 170,00	mensola fissa con scorri vassoi <i>fixed shelf with tray slide</i>	A122R	€ 170,00	mensola frontale ribaltabile con scorri vassoi <i>drop-down front shelf with tray slide</i>
6900CPB.2-W	€ 4.138,00	Wengé / Wengé				A120W	€ 170,00		A122W	€ 170,00	
6900CPB.2-N	€ 4.758,00	Nero / Black				A120N	€ 197,00		A122N	€ 197,00	
6900CPB.2-RAL	€ 5.048,00	RAL				A120RAL	€ 215,00		A122RAL	€ 210,00	
6900CPB.3-R	€ 4.588,00	Rovere / Oak	3x1/1	360W	113x68x144 h	A120R	€ 170,00		A123R	€ 210,00	
6900CPB.3-W	€ 4.588,00	Wengé / Wengé				A120W	€ 170,00		A123W	€ 210,00	
6900CPB.3-N	€ 5.278,00	Nero / Black				A120N	€ 197,00		A123N	€ 245,00	
6900CPB.3-RAL	€ 5.598,00	RAL				A120RAL	€ 215,00		A123RAL	€ 280,00	
6900CPB.4-R	€ 5.289,00	Rovere / Oak	4x1/1	550W	161x68x144 h	A120R	€ 170,00		A124R	€ 258,00	
6900CPB.4-W	€ 5.289,00	Wengé / Wengé				A120W	€ 170,00		A124W	€ 258,00	
6900CPB.4-N	€ 6.083,00	Nero / Black				A120N	€ 197,00		A124N	€ 299,00	
6900CPB.4-RAL	€ 6.452,00	RAL				A120RAL	€ 215,00		A124RAL	€ 337,00	
6900CPB.5-R	€ 5.847,00	Rovere / Oak	5x1/1	480W	193x68x144 h	A120R	€ 170,00		A125R	€ 337,00	
6900CPB.5-W	€ 5.847,00	Wengé / Wengé				A120W	€ 170,00		A125W	€ 337,00	
6900CPB.5-N	€ 6.722,00	Nero / Black				A120N	€ 197,00		A125N	€ 393,00	
6900CPB.5-RAL	€ 7.132,00	RAL				A120RAL	€ 215,00		A125RAL	€ 474,00	
6900CPB.6-R	€ 6.401,00	Rovere / Oak	6x1/1	690W	226x68x144 h	A120R	€ 170,00	A126R	€ 384,00		
6900CPB.6-W	€ 6.401,00	Wengé / Wengé				A120W	€ 170,00	A126W	€ 384,00		
6900CPB.6-N	€ 7.360,00	Nero / Black				A120N	€ 197,00	A126N	€ 447,00		
6900CPB.6-RAL	€ 7.807,00	RAL				A120RAL	€ 215,00	A126RAL	€ 578,00		

OPTIONAL E ACCESSORI VALIDI PER ENTRAMBE LE VERSIONI

OPTIONALS AND ACCESSORIES SUITABLE FOR BOTH VERSIONS

OPTIONAL	PREZZO / PRICE	DESCRIZIONE / DESCRIPTION	PER / FOR
A156	€ 48,00	Rubinetto di scarico (obbligatorio per il pesce) <i>Drain tap (necessary for fish displaying)</i>	Tutti gli articoli <i>All Articles</i>

ACCESSORI / ACCESSORIES	PREZZO / PRICE	DESCRIZIONE / DESCRIPTION	GN
A142	€ 145,00	Mensola in tubo inox frontale, ribaltabile <i>Front drop-down stainless steel rodded tray slide</i>	2x1/1
A143	€ 161,00		3x1/1
A144	€ 206,00		4x1/1
A145	€ 303,00		5x1/1
A146	€ 316,00		6x1/1



ACCESSORI / ACCESSORIES	PREZZO / PRICE	DESCRIZIONE / DESCRIPTION	PER / FOR
A10	€ 39,00	1 Griglia liscia 1/1 GN / 1/1 GN Flat	Tutti gli articoli <i>All Articles</i>
A20	€ 46,00	2 Griglia asolata 1/1 GN / 1/1 GN Perforated	



BUFFET FREDDI CON PARAFIATO MOBILE - ILLUMINAZIONE A LED

REFRIGERATED SELF-SERVICE BUFFET TROLLEYS - ADJUSTABLE SNEEZE GUARD - LED LIGHTING

- Castello superiore in acciaio inox con illuminazione a led
- Parafiato mobile in vetro temperato
- Pannelli, ripiano (e sportelli nella versione armadiata) in legno multistrato
- Gambe in tubolare di acciaio inox AISI 304, finitura spazzolata
- Per la finitura colore NERO struttura in MDF idrorepellente protetto da trasparente
- Vasca in acciaio inox AISI 304 profonda cm 19 per bacinelle GN fino a cm 15 h (escluse)
- Foro sul fondo della vasca per lo scarico della condensa (con rubinetto a richiesta)
- **NB: per il pesce il rubinetto è obbligatorio**
- Pannello comandi con termostato-termometro digitale e interruttori di accensione con spia luminosa
- Tensione rete 230 Volt monofase 50 Hz, 60 Hz a richiesta
- Refrigerazione statica +4°C +10°C
- Cavo spiralato lunghezza 3mt., spina Schuko
- Ruote piroettanti ø cm 12,5, di cui 2 con freno

- *Stainless steel overhead gantry with led lighting*
- *Height-adjustable tempered glass sneeze guard*
- *Plywood panels, shelf (and doors in the cupboard version)*
- *AISI 304 stainless steel legs, brushed finish*
- *For BLACK finish: structure in water-repellent MDF with transparent coating*
- *AISI 304 stainless steel 19 cm-deep well for up to 15 cm-deep GN pans (not included)*
- *Condensate drain at the base of the well (drain tap available on request)*
- **Note: the drain tap is necessary for fish displaying**
- *Control panel with digital thermostat-thermometer and ON/OFF switch with warning light*
- *Mains supply: 230V, 50 Hz (60 Hz upon request), single-phase*
- *Static refrigeration +4°C +10°C*
- *3m long coiled cable, Schuko plug*
- *Swivel castors ø 12.5 cm, 2 with brake*

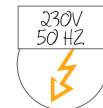
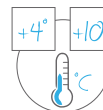

RAL

Laccatura opaca a scelta. Comunicare il codice RAL richiesto.
Matt lacquering. Please indicate the RAL code of the colour.



PARAFIATO MOBILE
ADJUSTABLE
SNEEZE GUARD

Optional bacinelle vedi pag. 78-79
Optional Gastronorms: see pp. 78-79

Art. 6900.4M-R + A124R(x2) + bacinelle / pans

VERSIONE A GIORNO

OPEN LOWER PART VERSION

NB: la singola mensola frontale viene montata dal lato opposto a quello dell'operatore salvo richiesta contraria
Note: when ordering one single front shelf, it is mounted on the opposite side to the operator one, unless otherwise specified.

ARTICOLO / ARTICLE	PREZZO / PRICE	FINITURA / FINISH	GN	POTENZA / POWER	MAX DIM. CM	ARTICOLO / ARTICLE	PREZZO / PRICE	FRONTALE / FRONT	ARTICOLO / ARTICLE	PREZZO / PRICE	FRONTALE / FRONT
6900.2M-R	€ 3.937,00	Rovere / Oak	2x1/1	200W	80x68x144 h	A120R	€ 170,00	mensola fissa con scorri vassoi fixed shelf with tray slide	A122R	€ 170,00	mensola frontale ribaltabile con scorri vassoi drop-down front shelf with tray slide
6900.2M-W	€ 3.937,00	Wengé / Wengé				A120W	€ 170,00		A122W	€ 170,00	
6900.2M-N	€ 4.433,00	Nero / Black				A120N	€ 197,00		A122N	€ 197,00	
6900.2M-RAL	€ 4.665,00	RAL				A120RAL	€ 215,00		A122RAL	€ 210,00	
6900.3M-R	€ 4.432,00	Rovere / Oak	3x1/1	360W	113x68x144 h	A120R	€ 170,00		A123R	€ 210,00	
6900.3M-W	€ 4.432,00	Wengé / Wengé				A120W	€ 170,00		A123W	€ 210,00	
6900.3M-N	€ 4.981,00	Nero / Black				A120N	€ 197,00		A123N	€ 245,00	
6900.3M-RAL	€ 5.238,00	RAL				A120RAL	€ 215,00		A123RAL	€ 280,00	
6900.4M-R	€ 5.126,00	Rovere / Oak	4x1/1	550W	161x68x144 h	A120R	€ 170,00		A124R	€ 258,00	
6900.4M-W	€ 5.126,00	Wengé / Wengé				A120W	€ 170,00		A124W	€ 258,00	
6900.4M-N	€ 5.760,00	Nero / Black				A120N	€ 197,00		A124N	€ 299,00	
6900.4M-RAL	€ 6.057,00	RAL				A120RAL	€ 215,00		A124RAL	€ 337,00	
6900.5M-R	€ 5.706,00	Rovere / Oak	5x1/1	480W	193x68x144 h	A120R	€ 170,00	A125R	€ 337,00		
6900.5M-W	€ 5.706,00	Wengé / Wengé				A120W	€ 170,00	A125W	€ 337,00		
6900.5M-N	€ 6.407,00	Nero / Black				A120N	€ 197,00	A125N	€ 393,00		
6900.5M-RAL	€ 6.735,00	RAL				A120RAL	€ 215,00	A125RAL	€ 474,00		
6900.6M-R	€ 6.284,00	Rovere / Oak	6x1/1	690W	226x68x144 h	A120R	€ 170,00	A126R	€ 384,00		
6900.6M-W	€ 6.284,00	Wengé / Wengé				A120W	€ 170,00	A126W	€ 384,00		
6900.6M-N	€ 7.052,00	Nero / Black				A120N	€ 197,00	A126N	€ 447,00		
6900.6M-RAL	€ 7.410,00	RAL				A120RAL	€ 215,00	A126RAL	€ 578,00		

BUFFET FREDDI CON PARAFIATO MOBILE - ILLUMINAZIONE A LED
REFRIGERATED SELF-SERVICE BUFFET TROLLEYS - ADJUSTABLE SNEEZE GUARD - LED LIGHTING



Art. 6900CPB.3M-N + A123N(x2) + A120N(x2) + bacinelle / pans



VERSIONE ARMADIATA: completo di schienale, pannelli laterali e sportelli
CUPBOARD VERSION: with back panel, side panels and doors

NB: la singola mensola frontale viene montata dal lato opposto a quello dell'operatore salvo richiesta contraria
Note: when ordering one single front shelf, it is mounted on the opposite side to the operator one, unless otherwise specified.

ARTICOLO / ARTICLE	PREZZO / PRICE	FINITURA / FINISH	GN	POTENZA / POWER	MAX DIM. CM	ARTICOLO / ARTICLE	PREZZO / PRICE	FRONTALE / FRONT	ARTICOLO / ARTICLE	PREZZO / PRICE	FRONTALE / FRONT
6900CPB.2M-R	€ 4.764,00	Rovere / Oak	2x1/1	200W	80x68x144 h	A120R	€ 170,00	mensola fissa con scorri vassoi <i>fixed shelf with tray slide</i>	A122R	€ 170,00	mensola frontale ribaltabile con scorri vassoi <i>drop-down front shelf with tray slide</i>
6900CPB.2M-W	€ 4.764,00	Wengé / Wengé				A120W	€ 170,00		A122W	€ 170,00	
6900CPB.2M-N	€ 5.385,00	Nero / Black				A120N	€ 197,00		A122N	€ 197,00	
6900CPB.2M-RAL	€ 5.675,00	RAL				A120RAL	€ 215,00		A122RAL	€ 210,00	
6900CPB.3M-R	€ 5.349,00	Rovere / Oak	3x1/1	360W	113x68x144 h	A120R	€ 170,00		A123R	€ 210,00	
6900CPB.3M-W	€ 5.349,00	Wengé / Wengé				A120W	€ 170,00		A123W	€ 210,00	
6900CPB.3M-N	€ 6.038,00	Nero / Black				A120N	€ 197,00		A123N	€ 245,00	
6900CPB.3M-RAL	€ 6.357,00	RAL				A120RAL	€ 215,00		A123RAL	€ 280,00	
6900CPB.4M-R	€ 6.185,00	Rovere / Oak	4x1/1	550W	161x68x144 h	A120R	€ 170,00		A124R	€ 258,00	
6900CPB.4M-W	€ 6.185,00	Wengé / Wengé				A120W	€ 170,00		A124W	€ 258,00	
6900CPB.4M-N	€ 6.977,00	Nero / Black				A120N	€ 197,00		A124N	€ 299,00	
6900CPB.4M-RAL	€ 7.348,00	RAL				A120RAL	€ 215,00		A124RAL	€ 337,00	
6900CPB.5M-R	€ 6.875,00	Rovere / Oak	5x1/1	480W	193x68x144 h	A120R	€ 170,00		A125R	€ 337,00	
6900CPB.5M-W	€ 6.875,00	Wengé / Wengé				A120W	€ 170,00		A125W	€ 337,00	
6900CPB.5M-N	€ 7.752,00	Nero / Black				A120N	€ 197,00		A125N	€ 393,00	
6900CPB.5M-RAL	€ 8.161,00	RAL				A120RAL	€ 215,00		A125RAL	€ 474,00	
6900CPB.6M-R	€ 7.565,00	Rovere / Oak	6x1/1	690W	226x68x144 h	A120R	€ 170,00	A126R	€ 384,00		
6900CPB.6M-W	€ 7.565,00	Wengé / Wengé				A120W	€ 170,00	A126W	€ 384,00		
6900CPB.6M-N	€ 8.524,00	Nero / Black				A120N	€ 197,00	A126N	€ 447,00		
6900CPB.6M-RAL	€ 8.970,00	RAL				A120RAL	€ 215,00	A126RAL	€ 578,00		

OPTIONAL E ACCESSORI VALIDI PER ENTRAMBE LE VERSIONI

OPTIONALS AND ACCESSORIES SUITABLE FOR BOTH VERSIONS

OPTIONAL	PREZZO / PRICE	DESCRIZIONE / DESCRIPTION	PER / FOR
A156	€ 48,00	Rubinetto di scarico (obbligatorio per il pesce) <i>Drain tap (necessary for fish displaying)</i>	Tutti gli articoli <i>All Articles</i>

ACCESSORI / ACCESSORIES	PREZZO / PRICE	DESCRIZIONE / DESCRIPTION	GN
A142	€ 145,00	Mensola in tubo inox frontale, ribaltabile <i>Front drop-down stainless steel rodded tray slide</i>	2x1/1
A143	€ 161,00		3x1/1
A144	€ 206,00		4x1/1
A145	€ 303,00		5x1/1
A146	€ 316,00		6x1/1



ACCESSORI / ACCESSORIES	PREZZO / PRICE	DESCRIZIONE / DESCRIPTION	PER / FOR
A10	€ 39,00	1 Griglia liscia 1/1 GN / 1/1 GN Flat	Tutti gli articoli <i>All Articles</i>
A20	€ 46,00	2 Griglia asolata 1/1 GN / 1/1 GN Perforated	

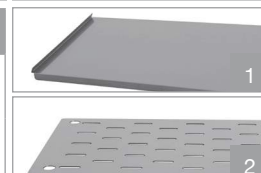

BUFFET CALDI CON PARAFIATO FISSO - ILLUMINAZIONE A LED HEATED SELF-SERVICE BUFFET TROLLEYS - FIXED SNEEZE GUARD - LED LIGHTING

- Castello superiore in acciaio inox con illuminazione a led
- Parafiato fisso in plexiglass
- Pannelli, ripiano (e sportelli nella versione armadiata) in legno multistrato
- Gambe in tubolare di acciaio inox AISI 304, finitura spazzolata
- Per la finitura colore NERO struttura in MDF idrorepellente protetto da trasparente
- Vasca in acciaio inox AISI 304 profonda cm 19 per bacinelle GN fino a cm 15 h (escluse)
- Rubinetto per lo scarico dell'acqua del bagnomaria
- Pannello comandi con termostato-termometro digitale e interruttori di accensione con spia luminosa
- Tensione rete 230 Volt monofase-50/60 Hz
- Riscaldamento a umido-bagnomaria con resistenza esterna alla vasca
- Cavo spiralato lunghezza 3mt., spina Schuko Per potenze uguali o superiori a 3000W, il cavo viene fornito libero senza spina.
- Ruote piroettanti ø cm 12,5, di cui 2 con freno

- *Stainless steel overhead gantry with led lighting*
- *Fixed plexiglass sneeze guard*
- *Plywood panels, shelf (and doors in the cupboard version)*
- *AISI 304 stainless steel legs, brushed finish*
- *For BLACK finish: structure in water-repellent MDF with transparent coating*
- *AISI 304 stainless steel 19 cm-deep well for up to 15 cm-deep GN pans (not included)*
- *Bain-marie drain plug*
- *Control panel with digital thermostat-thermometer and ON/OFF switch with warning light*
- *Mains supply: 230V, 50/60 Hz, single-phase*
- *Bain-marie heating with heating element outside the well*
- *3m long coiled cable, Schuko plug. For powers equal to or greater than 3000W, the cable is supplied free without plug. For the plug, see optional item T200*
- *Swivel castors ø 12.5 cm, 2 with brake*

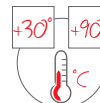

RAL

Laccatura opaca a scelta. Comunicare il codice RAL richiesto.

Matt lacquering. Please indicate the RAL code of the colour.



Optional bacinelle vedi pag. 78-79
Optional Gastronorms: see pp. 78-79

Art. 6910.4-RAL + A124RAL(x2) + bacinelle

VERSIONE A GIORNO

OPEN LOWER PART VERSION

NB: la singola mensola frontale viene montata dal lato opposto a quello dell'operatore salvo richiesta contraria

Note: when ordering one single front shelf, it is mounted on the opposite side to the operator one, unless otherwise specified.

ARTICOLO / ARTICLE	PREZZO / PRICE	FINITURA / FINISH	GN	POTENZA / POWER	MAX DIM. CM	ARTICOLO / ARTICLE	PREZZO / PRICE	FRONTALE / FRONT	ARTICOLO / ARTICLE	PREZZO / PRICE	FRONTALE / FRONT
6910.2-R	€ 2.511,00	Rovere / Oak	2x1/1	1200W	80x68x144 h	A120R	€ 170,00	mensola fissa con scorri vassoi fixed shelf with tray slide	A122R	€ 170,00	mensola frontale ribaltabile con scorri vassoi drop-down front shelf with tray slide
6910.2-W	€ 2.511,00	Wengé / Wengé				A120W	€ 170,00		A122W	€ 170,00	
6910.2-N	€ 2.887,00	Nero / Black				A120N	€ 197,00		A122N	€ 197,00	
6910.2-RAL	€ 3.063,00	RAL	A120RAL	€ 215,00	A122RAL	€ 210,00					
6910.3-R	€ 2.910,00	Rovere / Oak	3x1/1	1500W	113x68x144 h	A120R	€ 170,00		A123R	€ 210,00	
6910.3-W	€ 2.910,00	Wengé / Wengé				A120W	€ 170,00		A123W	€ 210,00	
6910.3-N	€ 3.347,00	Nero / Black				A120N	€ 197,00		A123N	€ 245,00	
6910.3-RAL	€ 3.550,00	RAL	A120RAL	€ 215,00	A123RAL	€ 280,00					
6910.4-R	€ 3.388,00	Rovere / Oak	4x1/1	2400W	161x68x144 h	A120R	€ 170,00		A124R	€ 258,00	
6910.4-W	€ 3.388,00	Wengé / Wengé				A120W	€ 170,00		A124W	€ 258,00	
6910.4-N	€ 3.896,00	Nero / Black				A120N	€ 197,00		A124N	€ 299,00	
6910.4-RAL	€ 4.134,00	RAL	A120RAL	€ 215,00	A124RAL	€ 337,00					
6910.5-R	€ 3.813,00	Rovere / Oak	5x1/1	3000W	193x68x144 h	A120R	€ 170,00	A125R	€ 337,00		
6910.5-W	€ 3.813,00	Wengé / Wengé				A120W	€ 170,00	A125W	€ 337,00		
6910.5-N	€ 4.384,00	Nero / Black				A120N	€ 197,00	A125N	€ 393,00		
6910.5-RAL	€ 4.650,00	RAL	A120RAL	€ 215,00	A125RAL	€ 474,00					
6910.6-R	€ 4.602,00	Rovere / Oak	6x1/1	3600W	226x68x144 h	A120R	€ 170,00	A126R	€ 384,00		
6910.6-W	€ 4.602,00	Wengé / Wengé				A120W	€ 170,00	A126W	€ 384,00		
6910.6-N	€ 5.292,00	Nero / Black				A120N	€ 197,00	A126N	€ 447,00		
6910.6-RAL	€ 5.615,00	RAL	A120RAL	€ 215,00	A126RAL	€ 578,00					

BUFFET CALDI CON PARAFIATO FISSO - ILLUMINAZIONE A LED
HEATED SELF-SERVICE BUFFET TROLLEYS - FIXED SNEEZE GUARD - LED LIGHTING



Art. 6910CPB.4-RAL + A124RAL(x2) + bacinelle / pans



VERSIONE ARMADIATA: completo di schienale, pannelli laterali e sportelli
CUPBOARD VERSION: with back panel, side panels and doors

NB: la singola mensola frontale viene montata dal lato opposto a quello dell'operatore salvo richiesta contraria
Note: when ordering one single front shelf, it is mounted on the opposite side to the operator one, unless otherwise specified.

ARTICOLO / ARTICLE	PREZZO / PRICE	FINITURA / FINISH	GN	POTENZA / POWER	MAX DIM. CM	ARTICOLO / ARTICLE	PREZZO / PRICE	FRONTALE / FRONT	ARTICOLO / ARTICLE	PREZZO / PRICE	FRONTALE / FRONT
6910CPB.2-R	€ 3.339,00	Rovere / Oak	2x1/1	1200W	80x68x144 h	A120R	€ 170,00	mensola fissa con scorri vassoi fixed shelf with tray slide	A122R	€ 170,00	mensola frontale ribaltabile con scorri vassoi drop-down front shelf with tray slide
6910CPB.2-W	€ 3.339,00	Wengé / Wengé				A120W	€ 170,00		A122W	€ 170,00	
6910CPB.2-N	€ 3.839,00	Nero / Black				A120N	€ 197,00		A122N	€ 197,00	
6910CPB.2-RAL	€ 4.072,00	RAL				A120RAL	€ 215,00		A122RAL	€ 210,00	
6910CPB.3-R	€ 3.828,00	Rovere / Oak	3x1/1	1500W	113x68x144 h	A120R	€ 170,00		A123R	€ 210,00	
6910CPB.3-W	€ 3.828,00	Wengé / Wengé				A120W	€ 170,00		A123W	€ 210,00	
6910CPB.3-N	€ 4.403,00	Nero / Black				A120N	€ 197,00		A123N	€ 245,00	
6910CPB.3-RAL	€ 4.669,00	RAL				A120RAL	€ 215,00		A123RAL	€ 280,00	
6910CPB.4-R	€ 4.446,00	Rovere / Oak	4x1/1	2400W	161x68x144 h	A120R	€ 170,00		A124R	€ 258,00	
6910CPB.4-W	€ 4.446,00	Wengé / Wengé				A120W	€ 170,00		A124W	€ 258,00	
6910CPB.4-N	€ 5.113,00	Nero / Black				A120N	€ 197,00		A124N	€ 299,00	
6910CPB.4-RAL	€ 5.424,00	RAL				A120RAL	€ 215,00		A124RAL	€ 337,00	
6910CPB.5-R	€ 4.981,00	Rovere / Oak	5x1/1	3000W	193x68x144 h	A120R	€ 170,00		A125R	€ 337,00	
6910CPB.5-W	€ 4.981,00	Wengé / Wengé				A120W	€ 170,00		A125W	€ 337,00	
6910CPB.5-N	€ 5.729,00	Nero / Black				A120N	€ 197,00		A125N	€ 393,00	
6910CPB.5-RAL	€ 6.075,00	RAL				A120RAL	€ 215,00		A125RAL	€ 474,00	
6910CPB.6-R	€ 5.882,00	Rovere / Oak	6x1/1	3600W	226x68x144 h	A120R	€ 170,00	A126R	€ 384,00		
6910CPB.6-W	€ 5.882,00	Wengé / Wengé				A120W	€ 170,00	A126W	€ 384,00		
6910CPB.6-N	€ 6.765,00	Nero / Black				A120N	€ 197,00	A126N	€ 447,00		
6910CPB.6-RAL	€ 7.175,00	RAL				A120RAL	€ 215,00	A126RAL	€ 578,00		

OPTIONAL E ACCESSORI VALIDI PER ENTRAMBE LE VERSIONI

OPTIONALS AND ACCESSORIES SUITABLE FOR BOTH VERSIONS

OPTIONAL	PREZZO / PRICE	DESCRIZIONE / DESCRIPTION	PER / FOR
A152	€ 272,00	Alimentazione 380 V / Mains supply 380V	Tutti gli articoli All Articles
A154	€ 219,00	Carico acqua da rete e scarico con rubinetto e troppopieno / Water loading from net, drain tap and overflow	
T200	€ 57,00	Spina mobile 2P+T-6h/250V - 16 A - IP67 (IEC 309) - per potenze fino a 3450W Mobile plug 2P+E-6h/250V - 16 A - IP67 (IEC 309) - for powers up to 3450W	

ACCESSORI / ACCESSORIES	PREZZO / PRICE	DESCRIZIONE / DESCRIPTION	GN
A142	€ 145,00	Mensola in tubo inox frontale, ribaltabile Front drop-down stainless steel rodded tray slide	2x1/1
A143	€ 161,00		3x1/1
A144	€ 206,00		4x1/1
A145	€ 303,00		5x1/1
A146	€ 316,00		6x1/1



ACCESSORI / ACCESSORIES	PREZZO / PRICE	DESCRIZIONE / DESCRIPTION	PER / FOR
A10	€ 39,00	1 Griglia liscia 1/1 GN / 1/1 GN Flat	Tutti gli articoli All Articles
A20	€ 46,00	2 Griglia asolata 1/1 GN / 1/1 GN Perforated	



BUFFET CALDI CON PARAFIATO FISSO - LAMPADE A INFRAROSSI

HEATED SELF-SERVICE BUFFET TROLLEYS - FIXED SNEEZE GUARD - INFRARED LAMPS

- Castello superiore in acciaio inox con lampade riscaldanti ad infrarossi
- Parafiato fisso in plexiglass
- Pannelli, ripiano (e sportelli nella versione armadiata) in legno multistrato
- Gambe in tubolare di acciaio inox AISI 304, finitura spazzolata
- Per la finitura colore NERO struttura in MDF idrorepellente protetto da trasparente
- Vasca in acciaio inox AISI 304 profonda cm 19 per bacinelle GN fino a cm 15 h (escluse)
- Rubinetto per lo scarico dell'acqua del bagnomaria
- Riscaldamento a umido-bagnomaria con resistenza esterna alla vasca
- Pannello comandi con termostato-termometro digitale e interruttori di accensione con spia luminosa
- Tensione rete 230 Volt monofase-50/60 Hz
- Cavo spiralato lunghezza 3mt., spina Schuko Per potenze uguali o superiori a 3000W, il cavo viene fornito libero senza spina.
- Ruote piroettanti ø cm 12,5, di cui 2 con freno

- *Stainless steel overhead gantry with upper heating set of infrared lamps*
- *Fixed plexiglass sneeze guard*
- *Plywood panels, shelf (and doors in the cupboard version)*
- *AISI 304 stainless steel legs, brushed finish*
- *For BLACK finish: structure in water-repellent MDF with transparent coating*
- *AISI 304 stainless steel 19 cm-deep well for up to 15 cm-deep GN pans (not included)*
- *Bain-marie drain plug*
- *Bain-marie heating with heating element outside the well*
- *Control panel with digital thermostat-thermometer and ON/OFF switch with warning light*
- *Mains supply: 230V, 50/60 Hz, single-phase*
- *3m long coiled cable, Schuko plug. For powers equal to or greater than 3000W, the cable is supplied free without plug.*
- *Swivel castors ø 12.5 cm, 2 with brake*

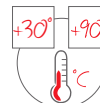

RAL



Laccatura opaca a scelta. Comunicare il codice RAL richiesto.

Matt lacquering. Please indicate the RAL code of the colour.



Optional bacinelle vedi pag. 78-79
Optional Gastronorms: see pp. 78-79

Art. 6910.4L-W + A124W(x2) + A20(x2) + bacinelle / pans

VERSIONE A GIORNO

OPEN LOWER PART VERSION

NB: la singola mensola frontale viene montata dal lato opposto a quello dell'operatore salvo richiesta contraria

Note: when ordering one single front shelf, it is mounted on the opposite side to the operator one, unless otherwise specified.

ARTICOLO / ARTICLE	PREZZO / PRICE	FINITURA / FINISH	GN	POTENZA / POWER	MAX DIM. CM	ARTICOLO / ARTICLE	PREZZO / PRICE	FRONTALE / FRONT	ARTICOLO / ARTICLE	PREZZO / PRICE	FRONTALE / FRONT
6910.2L-R	€ 2.837,00	Rovere / Oak	2x1/1	1200W	80x68x144 h	A120R	€ 170,00	mensola fissa con scorri vassoi fixed shelf with tray slide	A122R	€ 170,00	mensola frontale ribaltabile con scorri vassoi drop-down front shelf with tray slide
6910.2L-W	€ 2.837,00	Wengé / Wengé				A120W	€ 170,00		A122W	€ 170,00	
6910.2L-N	€ 3.215,00	Nero / Black				A120N	€ 197,00		A122N	€ 197,00	
6910.2L-RAL	€ 3.388,00	RAL				A120RAL	€ 215,00		A122RAL	€ 210,00	
6910.3L-R	€ 3.345,00	Rovere / Oak	3x1/1	1500W	113x68x144 h	A120R	€ 170,00		A123R	€ 210,00	
6910.3L-W	€ 3.345,00	Wengé / Wengé				A120W	€ 170,00		A123W	€ 210,00	
6910.3L-N	€ 3.782,00	Nero / Black				A120N	€ 197,00		A123N	€ 245,00	
6910.3L-RAL	€ 3.986,00	RAL				A120RAL	€ 215,00		A123RAL	€ 280,00	
6910.4L-R	€ 3.992,00	Rovere / Oak	4x1/1	2400W	161x68x144 h	A120R	€ 170,00		A124R	€ 258,00	
6910.4L-W	€ 3.992,00	Wengé / Wengé				A120W	€ 170,00		A124W	€ 258,00	
6910.4L-N	€ 4.500,00	Nero / Black				A120N	€ 197,00		A124N	€ 299,00	
6910.4L-RAL	€ 4.737,00	RAL				A120RAL	€ 215,00		A124RAL	€ 337,00	
6910.5L-R	€ 4.584,00	Rovere / Oak	5x1/1	3000W	193x68x144 h	A120R	€ 170,00	A125R	€ 337,00		
6910.5L-W	€ 4.584,00	Wengé / Wengé				A120W	€ 170,00	A125W	€ 337,00		
6910.5L-N	€ 5.155,00	Nero / Black				A120N	€ 197,00	A125N	€ 393,00		
6910.5L-RAL	€ 5.422,00	RAL				A120RAL	€ 215,00	A125RAL	€ 474,00		
6910.6L-R	€ 5.541,00	Rovere / Oak	6x1/1	3600W	226x68x144 h	A120R	€ 170,00	A126R	€ 384,00		
6910.6L-W	€ 5.541,00	Wengé / Wengé				A120W	€ 170,00	A126W	€ 384,00		
6910.6L-N	€ 6.231,00	Nero / Black				A120N	€ 197,00	A126N	€ 447,00		
6910.6L-RAL	€ 6.554,00	RAL				A120RAL	€ 215,00	A126RAL	€ 578,00		

BUFFET CALDI CON PARAFIATO FISSO - LAMPADE A INFRAROSSI
HEATED SELF-SERVICE BUFFET TROLLEYS - FIXED SNEEZE GUARD - INFRARED LAMPS



Art. 6910CPB.4L-W + A124W(x2)
+ bacinelle / pans



NB: la singola mensola frontale viene montata dal lato opposto a quello dell'operatore salvo richiesta contraria

Note: when ordering one single front shelf, it is mounted on the opposite side to the operator one, unless otherwise specified.

VERSIONE ARMADIATA: completo di schienale, pannelli laterali e sportelli
CUPBOARD VERSION: with back panel, side panels and doors

ARTICOLO / ARTICLE	PREZZO / PRICE	FINITURA / FINISH	GN	POTENZA / POWER	MAX DIM. CM	ARTICOLO / ARTICLE	PREZZO / PRICE	FRONTALE / FRONT	ARTICOLO / ARTICLE	PREZZO / PRICE	FRONTALE / FRONT
6910CPB.2L-R	€ 3.664,00	Rovere / Oak	2x1/1	1200W	80x68x144 h	A120R	€ 170,00	mensola fissa con scorri vassoi fixed shelf with tray slide	A122R	€ 170,00	mensola frontale ribaltabile con scorri vassoi drop-down front shelf with tray slide
6910CPB.2L-W	€ 3.664,00	Wengé / Wengé				A120W	€ 170,00		A122W	€ 170,00	
6910CPB.2L-N	€ 4.166,00	Nero / Black				A120N	€ 197,00		A122N	€ 197,00	
6910CPB.2L-RAL	€ 4.399,00	RAL				A120RAL	€ 215,00		A122RAL	€ 210,00	
6910CPB.3L-R	€ 4.262,00	Rovere / Oak	3x1/1	1500W	113x68x144 h	A120R	€ 170,00		A123R	€ 210,00	
6910CPB.3L-W	€ 4.262,00	Wengé / Wengé				A120W	€ 170,00		A123W	€ 210,00	
6910CPB.3L-N	€ 4.836,00	Nero / Black				A120N	€ 197,00		A123N	€ 245,00	
6910CPB.3L-RAL	€ 5.105,00	RAL				A120RAL	€ 215,00		A123RAL	€ 280,00	
6910CPB.4L-R	€ 5.051,00	Rovere / Oak	4x1/1	2400W	161x68x144 h	A120R	€ 170,00		A124R	€ 258,00	
6910CPB.4L-W	€ 5.051,00	Wengé / Wengé				A120W	€ 170,00		A124W	€ 258,00	
6910CPB.4L-N	€ 5.718,00	Nero / Black				A120N	€ 197,00		A124N	€ 299,00	
6910CPB.4L-RAL	€ 6.028,00	RAL				A120RAL	€ 215,00		A124RAL	€ 337,00	
6910CPB.5L-R	€ 5.751,00	Rovere / Oak	5x1/1	3000W	193x68x144 h	A120R	€ 170,00		A125R	€ 337,00	
6910CPB.5L-W	€ 5.751,00	Wengé / Wengé				A120W	€ 170,00		A125W	€ 337,00	
6910CPB.5L-N	€ 6.499,00	Nero / Black				A120N	€ 197,00		A125N	€ 393,00	
6910CPB.5L-RAL	€ 6.848,00	RAL				A120RAL	€ 215,00		A125RAL	€ 474,00	
6910CPB.6L-R	€ 6.821,00	Rovere / Oak	6x1/1	3600W	226x68x144 h	A120R	€ 170,00	A126R	€ 384,00		
6910CPB.6L-W	€ 6.821,00	Wengé / Wengé				A120W	€ 170,00	A126W	€ 384,00		
6910CPB.6L-N	€ 7.702,00	Nero / Black				A120N	€ 197,00	A126N	€ 447,00		
6910CPB.6L-RAL	€ 8.115,00	RAL				A120RAL	€ 215,00	A126RAL	€ 578,00		

OPTIONAL E ACCESSORI VALIDI PER ENTRAMBE LE VERSIONI

OPTIONALS AND ACCESSORIES SUITABLE FOR BOTH VERSIONS

OPTIONAL	PREZZO / PRICE	DESCRIZIONE / DESCRIPTION	PER / FOR
LB	€ 23,00	Lampade bianche / White lamps	Tutti gli articoli All Articles
A152	€ 272,00	Alimentazione 380 V / Mains supply 380V	
A154	€ 219,00	Carico acqua da rete e scarico con rubinetto e troppopieno / Water loading from net, drain tap and overflow	
T200	€ 57,00	Spina mobile 2P+T-6h/250V - 16 A - IP67 (IEC 309) - per potenze fino a 3450W Mobile plug 2P+E-6h/250V - 16 A - IP67 (IEC 309) - for powers up to 3450W	

ACCESSORI / ACCESSORIES	PREZZO / PRICE	DESCRIZIONE / DESCRIPTION	GN
A142	€ 145,00	Mensola in tubo inox frontale, ribaltabile Front drop-down stainless steel rodded tray slide	2x1/1
A143	€ 161,00		3x1/1
A144	€ 206,00		4x1/1
A145	€ 303,00		5x1/1
A146	€ 316,00		6x1/1



ACCESSORI / ACCESSORIES	PREZZO / PRICE	DESCRIZIONE / DESCRIPTION	PER / FOR
A10	€ 39,00	1 Griglia liscia 1/1 GN / 1/1 GN Flat	Tutti gli articoli All Articles
A20	€ 46,00	2 Griglia asolata 1/1 GN / 1/1 GN Perforated	



BUFFET CALDI CON PARAFIATO MOBILE - ILLUMINAZIONE A LED HEATED SELF-SERVICE BUFFET TROLLEYS - ADJUSTABLE SNEEZE GUARD - LED LIGHTING

- Castello superiore in acciaio inox con illuminazione a led
- Parafiato mobile in vetro temperato
- Pannelli, ripiano (e sportelli nella versione armadiata) in legno multistrato
- Gambe in tubolare di acciaio inox AISI 304, finitura spazzolata
- Per la finitura colore NERO struttura in MDF idrorepellente protetto da trasparente
- Vasca in acciaio inox AISI 304 profonda cm 19 per bacinelle GN fino a cm 15 h (escluse)
- Rubinetto per lo scarico dell'acqua del bagnomaria
- Riscaldamento a umido-bagnomaria con resistenza esterna alla vasca
- Pannello comandi con termostato-termometro digitale e interruttori di accensione con spia luminosa
- Tensione rete 230 Volt monofase-50/60 Hz
- Cavo spiralato lunghezza 3mt., spina Schuko Per potenze uguali o superiori a 3000W, il cavo viene fornito libero senza spina.
- Ruote piroettanti ø cm 12,5, di cui 2 con freno

- *Stainless steel overhead gantry with led lighting*
- *Height-adjustable tempered glass sneeze guard*
- *Plywood panels, shelf (and doors in the cupboard version)*
- *AISI 304 stainless steel legs, brushed finish*
- *For BLACK finish: structure in water-repellent MDF with transparent coating*
- *AISI 304 stainless steel 19 cm-deep well for up to 15 cm-deep GN pans (not included)*
- *Bain-marie drain plug*
- *Bain-marie heating with heating element outside the well*
- *Control panel with digital thermostat-thermometer and ON/OFF switch with warning light*
- *Mains supply: 230V, 50/60 Hz, single-phase*
- *3m long coiled cable, Schuko plug. For powers equal to or greater than 3000W, the cable is supplied free without plug. For the plug, see optional item T200*
- *Swivel castors ø 12.5 cm, 2 with brake*

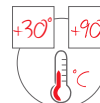

RAL

Laccatura opaca a scelta. Comunicare il codice RAL richiesto.

Matt lacquering. Please indicate the RAL code of the colour.

PARAFIATO MOBILE
ADJUSTABLE
SNEEZE GUARD



Optional bacinelle vedi pag. 78-79
Optional Gastronorms: see pp. 78-79

Art. 6910.4M-R + A124R(x2) + bacinelle / pans

NB: la singola mensola frontale viene montata dal lato opposto a quello dell'operatore salvo richiesta contraria

Note: when ordering one single front shelf, it is mounted on the opposite side to the operator one, unless otherwise specified.

VERSIONE A GIORNO

OPEN LOWER PART VERSION

ARTICOLO / ARTICLE	PREZZO / PRICE	FINITURA / FINISH	GN	POTENZA / POWER	MAX DIM. CM	ARTICOLO / ARTICLE	PREZZO / PRICE	FRONTALE / FRONT	ARTICOLO / ARTICLE	PREZZO / PRICE	FRONTALE / FRONT
6910.2M-R	€ 3.137,00	Rovere / Oak	2x1/1	1200W	80x68x144 h	A120R	€ 170,00	mensola fissa con scorri vassoi	A122R	€ 170,00	mensola frontale ribaltabile con scorri vassoi
6910.2M-W	€ 3.137,00	Wengé / Wengé				A120W	€ 170,00		A122W	€ 170,00	
6910.2M-N	€ 3.513,00	Nero / Black				A120N	€ 197,00		A122N	€ 197,00	
6910.2M-RAL	€ 3.689,00	RAL				A120RAL	€ 215,00		A122RAL	€ 210,00	
6910.3M-R	€ 3.670,00	Rovere / Oak	3x1/1	1500W	113x68x144 h	A120R	€ 170,00	fixed shelf with tray slide	A123R	€ 210,00	drop-down front shelf with tray slide
6910.3M-W	€ 3.670,00	Wengé / Wengé				A120W	€ 170,00		A123W	€ 210,00	
6910.3M-N	€ 4.107,00	Nero / Black				A120N	€ 197,00		A123N	€ 245,00	
6910.3M-RAL	€ 4.310,00	RAL				A120RAL	€ 215,00		A123RAL	€ 280,00	
6910.4M-R	€ 4.283,00	Rovere / Oak	4x1/1	2400W	161x68x144 h	A120R	€ 170,00	fixed shelf with tray slide	A124R	€ 258,00	drop-down front shelf with tray slide
6910.4M-W	€ 4.283,00	Wengé / Wengé				A120W	€ 170,00		A124W	€ 258,00	
6910.4M-N	€ 4.791,00	Nero / Black				A120N	€ 197,00		A124N	€ 299,00	
6910.4M-RAL	€ 5.029,00	RAL				A120RAL	€ 215,00		A124RAL	€ 337,00	
6910.5M-R	€ 4.842,00	Rovere / Oak	5x1/1	3000W	193x68x144 h	A120R	€ 170,00	fixed shelf with tray slide	A125R	€ 337,00	drop-down front shelf with tray slide
6910.5M-W	€ 4.842,00	Wengé / Wengé				A120W	€ 170,00		A125W	€ 337,00	
6910.5M-N	€ 5.413,00	Nero / Black				A120N	€ 197,00		A125N	€ 393,00	
6910.5M-RAL	€ 5.679,00	RAL				A120RAL	€ 215,00		A125RAL	€ 474,00	
6910.6M-R	€ 5.766,00	Rovere / Oak	6x1/1	3600W	226x68x144 h	A120R	€ 170,00	fixed shelf with tray slide	A126R	€ 384,00	drop-down front shelf with tray slide
6910.6M-W	€ 5.766,00	Wengé / Wengé				A120W	€ 170,00		A126W	€ 384,00	
6910.6M-N	€ 6.457,00	Nero / Black				A120N	€ 197,00		A126N	€ 447,00	
6910.6M-RAL	€ 6.779,00	RAL				A120RAL	€ 215,00		A126RAL	€ 578,00	

BUFFET CALDI CON PARAFIATO MOBILE - ILLUMINAZIONE A LED HEATED SELF-SERVICE BUFFET TROLLEYS - ADJUSTABLE SNEEZE GUARD - LED LIGHTING



Art. 6910CPB.4M-R + A124R(x2) + bacinelle / pans

VERSIONE ARMADIATA: completo di schienale, pannelli laterali e sportelli
CUPBOARD VERSION: with back panel, side panels and doors

NB: la singola mensola frontale viene montata dal lato opposto a quello dell'operatore salvo richiesta contraria
Note: when ordering one single front shelf, it is mounted on the opposite side to the operator one, unless otherwise specified.

ARTICOLO / ARTICLE	PREZZO / PRICE	FINITURA / FINISH	GN	POTENZA / POWER	MAX DIM. CM	ARTICOLO / ARTICLE	PREZZO / PRICE	FRONTALE / FRONT	ARTICOLO / ARTICLE	PREZZO / PRICE	FRONTALE / FRONT
6910CPB.2M-R	€ 3.964,00	Rovere / Oak	2x1/1	1200W	80x68x144 h	A120R	€ 170,00	mensola fissa con scorri vassoi fixed shelf with tray slide	A122R	€ 170,00	mensola frontale ribaltabile con scorri vassoi drop-down front shelf with tray slide
6910CPB.2M-W	€ 3.964,00	Wengé / Wengé				A120W	€ 170,00		A122W	€ 170,00	
6910CPB.2M-N	€ 4.464,00	Nero / Black				A120N	€ 197,00		A122N	€ 197,00	
6910CPB.2M-RAL	€ 4.698,00	RAL				A120RAL	€ 215,00		A122RAL	€ 210,00	
6910CPB.3M-R	€ 4.588,00	Rovere / Oak	3x1/1	1500W	113x68x144 h	A120R	€ 170,00		A123R	€ 210,00	
6910CPB.3M-W	€ 4.588,00	Wengé / Wengé				A120W	€ 170,00		A123W	€ 210,00	
6910CPB.3M-N	€ 5.162,00	Nero / Black				A120N	€ 197,00		A123N	€ 245,00	
6910CPB.3M-RAL	€ 5.430,00	RAL				A120RAL	€ 215,00		A123RAL	€ 280,00	
6910CPB.4M-R	€ 5.341,00	Rovere / Oak	4x1/1	2400W	161x68x144 h	A120R	€ 170,00		A124R	€ 258,00	
6910CPB.4M-W	€ 5.341,00	Wengé / Wengé				A120W	€ 170,00		A124W	€ 258,00	
6910CPB.4M-N	€ 6.009,00	Nero / Black				A120N	€ 197,00		A124N	€ 299,00	
6910CPB.4M-RAL	€ 6.320,00	RAL				A120RAL	€ 215,00		A124RAL	€ 337,00	
6910CPB.5M-R	€ 6.011,00	Rovere / Oak	5x1/1	3000W	193x68x144 h	A120R	€ 170,00		A125R	€ 337,00	
6910CPB.5M-W	€ 6.011,00	Wengé / Wengé				A120W	€ 170,00		A125W	€ 337,00	
6910CPB.5M-N	€ 6.758,00	Nero / Black				A120N	€ 197,00		A125N	€ 393,00	
6910CPB.5M-RAL	€ 7.105,00	RAL				A120RAL	€ 215,00		A125RAL	€ 474,00	
6910CPB.6M-R	€ 7.046,00	Rovere / Oak	6x1/1	3600W	226x68x144 h	A120R	€ 170,00	A126R	€ 384,00		
6910CPB.6M-W	€ 7.046,00	Wengé / Wengé				A120W	€ 170,00	A126W	€ 384,00		
6910CPB.6M-N	€ 7.928,00	Nero / Black				A120N	€ 197,00	A126N	€ 447,00		
6910CPB.6M-RAL	€ 8.339,00	RAL				A120RAL	€ 215,00	A126RAL	€ 578,00		

OPTIONAL E ACCESSORI VALIDI PER ENTRAMBE LE VERSIONI

OPTIONALS AND ACCESSORIES SUITABLE FOR BOTH VERSIONS

OPTIONAL	PREZZO / PRICE	DESCRIZIONE / DESCRIPTION	PER / FOR
A152	€ 272,00	Alimentazione 380 V / Mains supply 380V	Tutti gli articoli All Articles
A154	€ 219,00	Carico acqua da rete e scarico con rubinetto e troppopieno / Water loading from net, drain tap and overflow	
T200	€ 57,00	Spina mobile 2P+T-6h/250V - 16 A - IP67 (IEC 309) - per potenze fino a 3450W Mobile plug 2P+E-6h/250V - 16 A - IP67 (IEC 309) - for powers up to 3450W	

ACCESSORI / ACCESSORIES	PREZZO / PRICE	DESCRIZIONE / DESCRIPTION	GN
A142	€ 145,00	Mensola in tubo inox frontale, ribaltabile Front drop-down stainless steel rodded tray slide	2x1/1
A143	€ 161,00		3x1/1
A144	€ 206,00		4x1/1
A145	€ 303,00		5x1/1
A146	€ 316,00		6x1/1



ACCESSORI / ACCESSORIES	PREZZO / PRICE	DESCRIZIONE / DESCRIPTION	PER / FOR
A10	€ 39,00	Griglia liscia 1/1 GN / 1/1 GN Flat	Tutti gli articoli All Articles
A20	€ 46,00	Griglia asolata 1/1 GN / 1/1 GN Perforated	

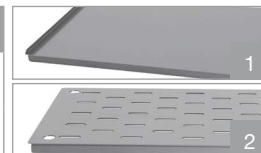

BUFFET MISTI FREDDO/CALDO CON PARAFIATO FISSO - ILLUMINAZIONE A LED MIXED HOT/COLD SELF-SERVICE BUFFET TROLLEYS - FIXED SNEEZE GUARD - LED LIGHTING

- Castello superiore in acciaio inox con illuminazione a led
- Parafiato fisso in plexiglass
- Pannelli, ripiano (e sportelli nella versione armadiata) in legno multistrato
- Gambe in tubolare di acciaio inox AISI 304, finitura spazzolata
- Per la finitura colore NERO struttura in MDF idrorepellente protetto da trasparente
- Vasca in acciaio inox AISI 304 profonda cm 19 per bacinelle GN fino a cm 15 h (escluse)
- Rubinetto per lo scarico dell'acqua del bagnomaria per la parte calda, vaschetta di raccolta della condensa all'interno del vano motore per la parte fredda (con rubinetto a richiesta)
- Riscaldamento a umido-bagnomaria con resistenza esterna alla vasca (vasche calde)
- Refrigerazione statica +4°C +10°C (vasche fredde)
- Pannello comandi con termostato-termometro digitale e interruttori di accensione con spia luminosa
- Tensione rete 230 Volt monofase 50 Hz, 60 Hz a richiesta
- Cavo spiralato lunghezza 3mt., spina Schuko
- Ruote piroettanti ø cm 12,5, di cui 2 con freno

- *Stainless steel overhead gantry with led lighting*
- *Fixed plexiglass sneeze guard*
- *Plywood panels, shelf (and doors in the cupboard version)*
- *AISI 304 stainless steel legs, brushed finish*
- *For BLACK finish: structure in water-repellent MDF with transparent coating*
- *AISI 304 stainless steel 19 cm-deep well for up to 15 cm-deep GN pans (not included)*
- *Bain-marie drain tap for the heated part and condensate drip tray inside the compressor compartment for the refrigerated part (with tap available on request)*
- *Bain-marie heating with heating element outside the well (heated wells)*
- *Static refrigeration +4°C +10°C (cold wells)*
- *Control panel with digital thermostat-thermometer and ON/OFF switch with warning light*
- *Mains supply: 230V, 50 Hz (60 Hz, upon request) single-phase*
- *3m long coiled cable, Schuko plug*
- *Swivel castors ø 12.5 cm, 2 with brake*

Rovere Oak

Wengé Wengé

Nero Black

RAL

Laccatura opaca a scelta. Comunicare il codice RAL richiesto.
Matt lacquering.
Please indicate the RAL code of the colour.

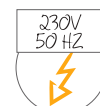
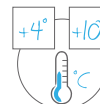
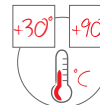

Optional bacinelle vedi pag. 78-79
Optional Gastronorms: see pp. 78-79

Art. 6920.6F3-W + A126W(x2) + A20(x6)

VERSIONE A GIORNO

OPEN LOWER PART VERSION

NB: la singola mensola frontale viene montata dal lato opposto a quello dell'operatore salvo richiesta contraria

Note: when ordering one single front shelf, it is mounted on the opposite side to the operator one, unless otherwise specified.

ARTICOLO / ARTICLE	PREZZO / PRICE	FINITURA / FINISH	GN	POTENZA / POWER	MAX DIM. CM	ARTICOLO / ARTICLE	PREZZO / PRICE	FRONTALE / FRONT	ARTICOLO / ARTICLE	PREZZO / PRICE	FRONTALE / FRONT		
6920.4F2-R	€ 4.603,00	Rovere / Oak	2 caldi + 2 freddi	1400W	161x68x144 h	A120R	€ 170,00	mensola fissa con scorri vassoio	A124R	€ 258,00	mensola frontale ribaltabile con scorri vassoio		
6920.4F2-W	€ 4.603,00	Wengé / Wengé				A120W	€ 170,00		A124W	€ 258,00			
6920.4F2-N	€ 5.294,00	Nero / Black				A120N	€ 197,00		A124N	€ 299,00			
6920.4F2-RAL	€ 5.616,00	RAL				A120RAL	€ 215,00		A124RAL	€ 337,00			
6920.5F2-R	€ 5.035,00	Rovere / Oak	3 caldi + 2 freddi	1700W	193x68x144 h	A120R	€ 170,00		A125R	€ 337,00			
6920.5F2-W	€ 5.035,00	Wengé / Wengé				A120W	€ 170,00		A125W	€ 337,00			
6920.5F2-N	€ 5.791,00	Nero / Black				A120N	€ 197,00		A125N	€ 393,00			
6920.5F2-RAL	€ 6.144,00	RAL				A120RAL	€ 215,00		A125RAL	€ 474,00			
6920.5F3-R	€ 4.998,00	Rovere / Oak	2 caldi + 3 freddi	15600W	193x68x144 h	A120R	€ 170,00		fixed shelf with tray slide	A125R		€ 337,00	drop-down front shelf with tray slide
6920.5F3-W	€ 4.998,00	Wengé / Wengé				A120W	€ 170,00			A125W		€ 337,00	
6920.5F3-N	€ 5.746,00	Nero / Black				A120N	€ 197,00			A125N		€ 393,00	
6920.5F3-RAL	€ 6.095,00	RAL				A120RAL	€ 215,00			A125RAL		€ 474,00	
6920.6F3-R	€ 5.421,00	Rovere / Oak	3 caldi + 3 freddi	1860W	226x68x144 h	A120R	€ 170,00	A126R		€ 384,00			
6920.6F3-W	€ 5.421,00	Wengé / Wengé				A120W	€ 170,00	A126W		€ 384,00			
6920.6F3-N	€ 6.234,00	Nero / Black				A120N	€ 197,00	A126N		€ 447,00			
6920.6F3-RAL	€ 6.612,00	RAL				A120RAL	€ 215,00	A126RAL		€ 578,00			

BUFFET MISTI FREDDO/CALDO CON PARAFIATO FISSO - ILLUMINAZIONE A LED
MIXED HOT/COLD SELF-SERVICE BUFFET TROLLEYS - FIXED SNEEZE GUARD - LED LIGHTING



Art. 6920CPB.6F3-W + A126W(x2) + A20(x6)

VERSIONE ARMADIATA: completo di schienale, pannelli laterali e sportelli
CUPBOARD VERSION: with back panel, side panels and doors

NB: la singola mensola frontale viene montata dal lato opposto a quello dell'operatore salvo richiesta contraria
Note: when ordering one single front shelf, it is mounted on the opposite side to the operator one, unless otherwise specified.

ARTICOLO / ARTICLE	PREZZO / PRICE	FINITURA / FINISH	GN	POTENZA / POWER	MAX DIM. CM	ARTICOLO / ARTICLE	PREZZO / PRICE	FRONTALE / FRONT	ARTICOLO / ARTICLE	PREZZO / PRICE	FRONTALE / FRONT		
6920CPB.4F2-R	€ 5.661,00	Rovere / Oak	2 caldi + 2 freddi	1400W	161x68x144 h	A120R	€ 170,00	mensola fissa con scorri vassoi	A124R	€ 258,00	mensola frontale ribaltabile con scorri vassoi		
6920CPB.4F2-W	€ 5.661,00	Wengé / Wengé				A120W	€ 170,00		A124W	€ 258,00			
6920CPB.4F2-N	€ 6.511,00	Nero / Black				A120N	€ 197,00		A124N	€ 299,00			
6920CPB.4F2-RAL	€ 6.907,00	RAL				A120RAL	€ 215,00		A124RAL	€ 337,00			
6920CPB.5F2-R	€ 6.205,00	Rovere / Oak	3 caldi + 2 freddi	1700W	193x68x144 h	A120R	€ 170,00		A125R	€ 337,00			
6920CPB.5F2-W	€ 6.205,00	Wengé / Wengé				A120W	€ 170,00		A125W	€ 337,00			
6920CPB.5F2-N	€ 7.135,00	Nero / Black				A120N	€ 197,00		A125N	€ 393,00			
6920CPB.5F2-RAL	€ 7.569,00	RAL				A120RAL	€ 215,00		A125RAL	€ 474,00			
6920CPB.5F3-R	€ 6.165,00	Rovere / Oak	2 caldi + 3 freddi	15600W	193x68x144 h	A120R	€ 170,00		fixed shelf with tray slide	A125R		€ 337,00	drop-down front shelf with tray slide
6920CPB.5F3-W	€ 6.165,00	Wengé / Wengé				A120W	€ 170,00			A125W		€ 337,00	
6920CPB.5F3-N	€ 7.091,00	Nero / Black				A120N	€ 197,00			A125N		€ 393,00	
6920CPB.5F3-RAL	€ 7.522,00	RAL				A120RAL	€ 215,00			A125RAL		€ 474,00	
6920CPB.6F3-R	€ 6.701,00	Rovere / Oak	3 caldi + 3 freddi	1860W	226x68x144 h	A120R	€ 170,00	A126R		€ 384,00			
6920CPB.6F3-W	€ 6.701,00	Wengé / Wengé				A120W	€ 170,00	A126W		€ 384,00			
6920CPB.6F3-N	€ 7.704,00	Nero / Black				A120N	€ 197,00	A126N		€ 447,00			
6920CPB.6F3-RAL	€ 8.175,00	RAL				A120RAL	€ 215,00	A126RAL		€ 578,00			

OPTIONAL E ACCESSORI VALIDI PER ENTRAMBE LE VERSIONI

OPTIONALS AND ACCESSORIES SUITABLE FOR BOTH VERSIONS

OPTIONAL	PREZZO / PRICE	DESCRIZIONE / DESCRIPTION	PER / FOR
A156	€ 48,00	Rubinetto di scarico (obbligatorio per il pesce) <i>Drain tap (necessary for fish displaying)</i>	Tutti gli articoli <i>All Articles</i>

ACCESSORI / ACCESSORIES	PREZZO / PRICE	DESCRIZIONE / DESCRIPTION	GN
A144	€ 206,00	Mensola in tubo inox frontale, ribaltabile <i>Front drop-down stainless steel rodded tray slide</i>	4x1/1
A145	€ 303,00		5x1/1
A146	€ 316,00		6x1/1

ACCESSORI / ACCESSORIES	PREZZO / PRICE	DESCRIZIONE / DESCRIPTION	PER / FOR
A10	€ 39,00	1 Griglia liscia 1/1 GN / 1/1 GN Flat	Tutti gli articoli <i>All Articles</i>
A20	€ 46,00	2 Griglia asolata 1/1 GN / 1/1 GN Perforated	

BUFFET MISTI FREDDO/CALDO CON PARAFIATO MOBILE - ILLUMINAZIONE A LED MIXED HOT/COLD SELF-SERVICE BUFFET TROLLEYS - ADJUSTABLE SNEEZE GUARD - LED LIGHTING

- Castello superiore in acciaio inox con illuminazione a led
- Parafiato mobile in vetro temperato
- Pannelli, ripiano (e sportelli nella versione armadiata) in legno multistrato
- Gambe in tubolare di acciaio inox AISI 304, finitura spazzolata
- Per la finitura colore NERO struttura in MDF idrorepellente protetto da trasparente
- Vasca in acciaio inox AISI 304 profonda cm 19 per bacinelle GN fino a cm 15 h (escluse)
- Rubinetto per lo scarico dell'acqua del bagnomaria per la parte calda, vaschetta di raccolta della condensa all'interno del vano motore per la parte fredda (con rubinetto a richiesta)
- Riscaldamento a umido-bagnomaria con resistenza esterna alla vasca (vasche calde)
- Refrigerazione statica +4°C +10°C (vasche fredde)
- Pannello comandi con termostato-termometro digitale e interruttori di accensione con spia luminosa
- Tensione rete 230 Volt monofase 50 Hz, 60 Hz a richiesta
- Cavo spiralato lunghezza 3mt., spina Schuko
- Ruote piroettanti ø cm 12,5, di cui 2 con freno

- *Stainless steel overhead gantry with led lighting*
- *Height-adjustable tempered glass sneeze guard*
- *Plywood panels, shelf (and doors in the cupboard version)*
- *AISI 304 stainless steel legs, brushed finish*
- *For BLACK finish: structure in water-repellent MDF with transparent coating*
- *AISI 304 stainless steel 19 cm-deep well for up to 15 cm-deep GN pans (not included)*
- *Bain-marie drain tap for the heated part and condensate drip tray inside the compressor compartment for the refrigerated part (with tap available on request)*
- *Bain-marie heating with heating element outside the well (heated wells)*
- *Static refrigeration +4°C +10°C (cold wells)*
- *Control panel with digital thermostat-thermometer and ON/OFF switch with warning light*
- *Mains supply: 230V, 50 Hz (60 Hz upon request), single-phase*
- *3m long coiled cable, Schuko plug*
- *Swivel castors ø 12.5 cm, 2 with brake*



Laccatura opaca a scelta. Comunicare il codice RAL richiesto.
Matt lacquering. Please indicate the RAL code of the colour.

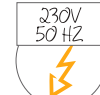
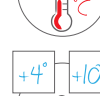

PARAFIATO MOBILE
ADJUSTABLE
SNEEZE GUARD



Optional bacinelle vedi pag. 78-79
Optional Gastronorms: see pp. 78-79

Art. 6920.6F3M-W + A126W(x2) + bacinelle / pans

VERSIONE A GIORNO OPEN LOWER PART VERSION

NB: la singola mensola frontale viene montata dal lato opposto a quello dell'operatore salvo richiesta contraria

Note: when ordering one single front shelf, it is mounted on the opposite side to the operator one, unless otherwise specified.

ARTICOLO / ARTICLE	PREZZO / PRICE	FINITURA / FINISH	GN	POTENZA / POWER	MAX DIM. CM	ARTICOLO / ARTICLE	PREZZO / PRICE	FRONTALE / FRONT	ARTICOLO / ARTICLE	PREZZO / PRICE	FRONTALE / FRONT		
6920.4F2M-R	€ 5.499,00	Rovere / Oak	2 caldi + 2 freddi	1400W	161x68x144 h	A120R	€ 170,00	mensola fissa con scorri vassoio	A124R	€ 258,00	mensola frontale ribaltabile con scorri vassoio		
6920.4F2M-W	€ 5.499,00	Wengé / Wengé				A120W	€ 170,00		A124W	€ 258,00			
6920.4F2M-N	€ 6.189,00	Nero / Black				A120N	€ 197,00		A124N	€ 299,00			
6920.4F2M-RAL	€ 6.511,00	RAL				A120RAL	€ 215,00		A124RAL	€ 337,00			
6920.5F2M-R	€ 6.065,00	Rovere / Oak	3 caldi + 2 freddi	1700W	193x68x144 h	A120R	€ 170,00		A125R	€ 337,00			
6920.5F2M-W	€ 6.065,00	Wengé / Wengé				A120W	€ 170,00		A125W	€ 337,00			
6920.5F2M-N	€ 6.821,00	Nero / Black				A120N	€ 197,00		A125N	€ 393,00			
6920.5F2M-RAL	€ 7.173,00	RAL				A120RAL	€ 215,00		A125RAL	€ 474,00			
6920.5F3M-R	€ 6.026,00	Rovere / Oak	2 caldi + 3 freddi	15600W	193x68x144 h	A120R	€ 170,00		fixed shelf with tray slide	A125R		€ 337,00	drop-down front shelf with tray slide
6920.5F3M-W	€ 6.026,00	Wengé / Wengé				A120W	€ 170,00			A125W		€ 337,00	
6920.5F3M-N	€ 6.774,00	Nero / Black				A120N	€ 197,00			A125N		€ 393,00	
6920.5F3M-RAL	€ 7.125,00	RAL				A120RAL	€ 215,00			A125RAL		€ 474,00	
6920.6F3M-R	€ 6.584,00	Rovere / Oak	3 caldi + 3 freddi	1860W	226x68x144 h	A120R	€ 170,00	A126R		€ 384,00			
6920.6F3M-W	€ 6.584,00	Wengé / Wengé				A120W	€ 170,00	A126W		€ 384,00			
6920.6F3M-N	€ 7.398,00	Nero / Black				A120N	€ 197,00	A126N		€ 447,00			
6920.6F3M-RAL	€ 7.776,00	RAL				A120RAL	€ 215,00	A126RAL		€ 578,00			

BUFFET MISTI FREDDO/CALDO CON PARAFIATO MOBILE - ILLUMINAZIONE A LED
MIXED HOT/COLD SELF-SERVICE BUFFET TROLLEYS - ADJUSTABLE SNEEZE GUARD - LED LIGHTING



Art. 6920CPB.6F3M-W + A126W(x2) + bacinelle / pans

VERSIONE ARMADIATA: completo di schienale, pannelli laterali e sportelli
CUPBOARD VERSION: with back panel, side panels and doors

NB: la singola mensola frontale viene montata dal lato opposto a quello dell'operatore salvo richiesta contraria
Note: when ordering one single front shelf, it is mounted on the opposite side to the operator one, unless otherwise specified.

ARTICOLO / ARTICLE	PREZZO / PRICE	FINITURA / FINISH	GN	POTENZA / POWER	MAX DIM. CM	ARTICOLO / ARTICLE	PREZZO / PRICE	FRONTALE / FRONT	ARTICOLO / ARTICLE	PREZZO / PRICE	FRONTALE / FRONT
6920CPB.4F2M-R	€ 6.556,00	Rovere / Oak	2 caldi + 2 freddi	1400W	161x68x144 h	A120R	€ 170,00	mensola fissa con scorri vassoi fixed shelf with tray slide	A124R	€ 258,00	mensola frontale ribaltabile con scorri vassoi drop-down front shelf with tray slide
6920CPB.4F2M-W	€ 6.556,00	Wengé / Wengé				A120W	€ 170,00		A124W	€ 258,00	
6920CPB.4F2M-N	€ 7.405,00	Nero / Black				A120N	€ 197,00		A124N	€ 299,00	
6920CPB.4F2M-RAL	€ 7.800,00	RAL				A120RAL	€ 215,00		A124RAL	€ 337,00	
6920CPB.5F2M-R	€ 7.234,00	Rovere / Oak	3 caldi + 2 freddi	1700W	193x68x144 h	A120R	€ 170,00		A125R	€ 337,00	
6920CPB.5F2M-W	€ 7.234,00	Wengé / Wengé				A120W	€ 170,00		A125W	€ 337,00	
6920CPB.5F2M-N	€ 8.164,00	Nero / Black				A120N	€ 197,00		A125N	€ 393,00	
6920CPB.5F2M-RAL	€ 8.598,00	RAL				A120RAL	€ 215,00		A125RAL	€ 474,00	
6920CPB.5F3M-R	€ 7.195,00	Rovere / Oak	2 caldi + 3 freddi	15600W	193x68x144 h	A120R	€ 170,00		A125R	€ 337,00	
6920CPB.5F3M-W	€ 7.195,00	Wengé / Wengé				A120W	€ 170,00		A125W	€ 337,00	
6920CPB.5F3M-N	€ 8.119,00	Nero / Black				A120N	€ 197,00		A125N	€ 393,00	
6920CPB.5F3M-RAL	€ 8.551,00	RAL				A120RAL	€ 215,00		A125RAL	€ 474,00	
6920CPB.6F3M-R	€ 7.865,00	Rovere / Oak	3 caldi + 3 freddi	1860W	226x68x144 h	A120R	€ 170,00	A126R	€ 384,00		
6920CPB.6F3M-W	€ 7.865,00	Wengé / Wengé				A120W	€ 170,00	A126W	€ 384,00		
6920CPB.6F3M-N	€ 8.868,00	Nero / Black				A120N	€ 197,00	A126N	€ 447,00		
6920CPB.6F3M-RAL	€ 9.338,00	RAL				A120RAL	€ 215,00	A126RAL	€ 578,00		

OPTIONAL E ACCESSORI VALIDI PER ENTRAMBE LE VERSIONI

OPTIONALS AND ACCESSORIES SUITABLE FOR BOTH VERSIONS

OPTIONAL	PREZZO / PRICE	DESCRIZIONE / DESCRIPTION	PER / FOR
A156	€ 48,00	Rubinetto di scarico (obbligatorio per il pesce) <i>Drain tap (necessary for fish displaying)</i>	Tutti gli articoli <i>All Articles</i>

ACCESSORI / ACCESSORIES	PREZZO / PRICE	DESCRIZIONE / DESCRIPTION	GN
A144	€ 206,00	Mensola in tubo inox frontale, ribaltabile <i>Front drop-down stainless steel rodded tray slide</i>	4x1/1
A145	€ 303,00		5x1/1
A146	€ 316,00		6x1/1

ACCESSORI / ACCESSORIES	PREZZO / PRICE	DESCRIZIONE / DESCRIPTION	PER / FOR
A10	€ 39,00	1 Griglia liscia 1/1 GN / 1/1 GN Flat	Tutti gli articoli <i>All Articles</i>
A20	€ 46,00	2 Griglia asolata 1/1 GN / 1/1 GN Perforated	

DROP-IN FREDDO CON PARAFIATO REFRIGERATED DROP-IN WITH SNEEZE GUARD

- Castello superiore in acciaio inox AISI 304 con illuminazione a led completo di parafiato fisso in plexiglass o mobile in vetro temperato
- Vasca in acciaio inox AISI 304 profonda cm 19 per bacinelle GN fino a cm 15 h (escluse)
- Scarico sul fondo della vasca, vaschetta di raccolta della condensa oppure scarico esterno con rubinetto (optional)
- Pannello comandi con termostato-termometro digitale e interruttori di accensione con spia luminosa
- Tensione rete 230 Volt monofase-50 Hz, 60 Hz a richiesta
- Refrigerazione statica +4°C +10°C
- Cavo spiralato lunghezza 3mt., spina Schuko
- AISI 304 stainless steel overhead gantry with fixed plexiglass sneeze guard or height-adjustable in tempered glass, led lighting
- AISI 304 stainless steel 19 cm-deep well for up to 15 cm-deep GN pans (not included)
- Drain at the base of well and condensate drip tray or external drain with tap (optional)
- Control panel with digital thermostat-thermometer and ON/OFF switch with warning light
- Mains supply: 230V, single-phase - 50 Hz (60 Hz upon request)
- Static refrigeration +4°C +10°C
- 3m long spiral cable, Schuko plug

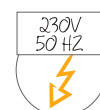
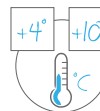

Optional bacinelle vedi pag. 78-79
Optional Gastronorms: see pp. 78-79

Art. 6980.4 + A20(x4)

ARTICOLO / ARTICLE	PREZZO / PRICE	GN	PARAFIATO / SNEEZE GUARD	ILLUMINAZIONE / LIGHTING	POTENZA / POWER	MAX DIM. CM
6980.2	€ 2.578,00	2x1/1	Fisso Fixed	Led Led	200W	80x68x111 h
6980.3	€ 2.796,00	3x1/1			360W	113x68x111 h
6980.4	€ 3.210,00	4x1/1			550W	161x68x111 h
6980.5	€ 3.482,00	5x1/1			480W	193x68x111 h
6980.6	€ 3.786,00	6x1/1			690W	226x68x111 h
6980.2M	€ 3.204,00	2x1/1			Mobile Adjustable	Led Led
6980.3M	€ 3.556,00	3x1/1	360W	113x68x111 h		
6980.4M	€ 4.104,00	4x1/1	550W	161x68x111 h		
6980.5M	€ 4.512,00	5x1/1	480W	193x68x111 h		
6980.6M	€ 4.949,00	6x1/1	690W	226x68x111 h		

OPTIONAL	PREZZO / PRICE	DESCRIZIONE / DESCRIPTION	PER / FOR
A156	€ 48,00	Rubinetto di scarico Drain tap	Tutti gli articoli All Articles

ACCESSORI / ACCESSORIES	PREZZO / PRICE	DESCRIZIONE / DESCRIPTION	PER / FOR
A10	€ 39,00	Griglia liscia 1/1 GN / 1/1 GN Flat	Tutti gli articoli All Articles
A20	€ 46,00	Griglia asolata 1/1 GN / 1/1 GN Perforated	

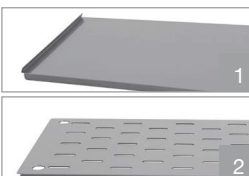

- Vasca in acciaio inox AISI 304 profonda cm 19 per bacinelle GN fino a cm 15 h (escluse)
 - Scarico sul fondo della vasca, vaschetta di raccolta della condensa oppure scarico esterno con rubinetto (optional)
 - Pannello comandi con termostato-termometro digitale e interruttori di accensione con spia luminosa
 - Tensione rete 230 Volt monofase-50 Hz, 60 Hz a richiesta
 - Refrigerazione statica +4°C +10°C
 - Cavo spiralato lunghezza 3mt., spina Schuko
- *AISI 304 stainless steel 19 cm-deep well for up to 15 cm-deep GN pans (not included)*
 - *Drain at the base of well and condensate drip tray or external drain with tap (optional)*
 - *Control panel with digital thermostat-thermometer and ON/OFF switch with warning light*
 - *Mains supply: 230V, single-phase - 50/60 Hz (60 Hz upon request)*
 - *Static refrigeration +4°C +10°C*
 - *3m long spiral cable, Schuko plug*

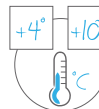

Art. 6980.4B + A20(x4)

Optional bacinelle vedi pag. 78-79
Optional Gastronorms: see pp. 78-79

ARTICOLO / ARTICLE	PREZZO / PRICE	GN	DESCRIZIONE / DESCRIPTION	POTENZA / POWER	MAX DIM. CM
6980.2B	€ 1.920,00	2x1/1	Solo vasca Well only	190W	80x68x55 h
6980.3B	€ 2.089,00	3x1/1		350W	113x68x55 h
6980.4B	€ 2.418,00	4x1/1		450W	161x68x55 h
6980.5B	€ 2.610,00	5x1/1		460W	193x68x55 h
6980.6B	€ 2.830,00	6x1/1		460W	226x68x55 h

OPTIONAL	PREZZO / PRICE	DESCRIZIONE / DESCRIPTION	PER / FOR
A156	€ 48,00	Rubinetto di scarico Drain tap	Tutti gli articoli All Articles

ACCESSORI / ACCESSORIES	PREZZO / PRICE	DESCRIZIONE / DESCRIPTION	PER / FOR
A10	€ 39,00	Griglia liscia 1/1 GN / 1/1 GN Flat	Tutti gli articoli All Articles
A20	€ 46,00	Griglia asolata 1/1 GN / 1/1 GN Perforated	

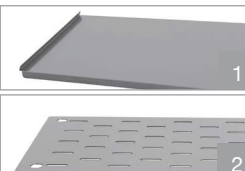

DROP-IN CALDO CON PARAFIATO HEATED DROP-IN WITH SNEEZE GUARD

- Castello superiore in acciaio inox AISI 304 completo di parafiato in plexiglass fisso o mobile in vetro temperato
- Illuminazione a led oppure set riscaldante composto da lampade a infrarossi con luce rossa o lampade con luce bianca (a richiesta)
- Vasca in acciaio inox AISI 304 profonda cm 19 per bacinelle GN fino a cm 15 h (escluse)
- Scarico acqua bagnomaria (optional carico acqua da rete e troppopieno)
- Riscaldamento a umido-bagnomaria con resistenza esterna alla vasca
- Pannello comandi con termostato-termometro digitale e interruttori di accensione con spia luminosa
- Tensione rete 230 Volt monofase-50/60 Hz (optional 380 Volt trifase)
- Cavo spiralato lunghezza 3mt., spina Schuko Per potenze uguali o superiori a 3000W, il cavo viene fornito libero senza spina.
- AISI 304 stainless steel overhead gantry, with fixed plexiglass sneeze guard or height-adjustable in tempered glass
- Led lighting or heating set of infrared lamps with red light (white light on request)
- AISI 304 stainless steel 19 cm-deep well for up to 15 cm-deep GN pans (not included)
- Drain at base (optional water loading from net and overflow)
- Bain-marie heating with heating element outside the well
- Control panel with digital thermostat-thermometer and ON/OFF switch with warning light
- Mains supply: 230V, - 50/60 Hz, single-phase (optional 380V three-phase)
- 3m long spiral cable, Schuko plug. For powers equal to or greater than 3000W, the cable is supplied free without plug.

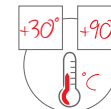

Optional bacinelle vedi pag. 78-79
Optional Gastronorms: see pp. 78-79

Art. 6990.4 + A20(x4)

ARTICOLO / ARTICLE	PREZZO / PRICE	GN	PARAFIATO / SNEEZE GUARD	ILLUMINAZIONE / LIGHTING	POTENZA / POWER	MAX DIM. CM
6990.2	€ 1.949,00	2x1/1	Fisso Fixed	Led Led	1200W	80x68x78 h
6990.3	€ 2.257,00	3x1/1			1500W	113x68x78 h
6990.4	€ 2.642,00	4x1/1			2400W	161x68x78 h
6990.5	€ 3.060,00	5x1/1			3000W	193x68x78 h
6990.6	€ 3.525,00	6x1/1			3600W	226x68x78 h
6990.2M	€ 2.574,00	2x1/1			Mobile Adjustable	Led Led
6990.3M	€ 3.016,00	3x1/1	1500W	113x68x78 h		
6990.4M	€ 3.535,00	4x1/1	2400W	161x68x78 h		
6990.5M	€ 4.089,00	5x1/1	3000W	193x68x78 h		
6990.6M	€ 4.688,00	6x1/1	3600W	226x68x78 h		
6990.2L	€ 2.274,00	2x1/1	Fisso Fixed	Lampade Infrarossi Infrared lamps		
6990.3L	€ 2.690,00	3x1/1			2250W	113x68x78 h
6990.4L	€ 3.244,00	4x1/1			3400W	161x68x78 h
6990.5L	€ 3.831,00	5x1/1			4250W	193x68x78 h
6990.6L	€ 4.463,00	6x1/1			5100W	226x68x78 h

OPTIONAL	PREZZO / PRICE	DESCRIZIONE / DESCRIPTION	PER / FOR
A152	€ 272,00	Alimentazione 380 V / Mains supply 380V	Tutti gli articoli All Articles
A154	€ 219,00	Carico acqua da rete e scarico con rubinetto e troppopieno / Water loading from net, drain tap and overflow	
T200	€ 57,00	Spina mobile 2P+T-6h/250V - 16 A - IP67 (IEC 309) - per potenze fino a 3450W Mobile plug 2P+E-6h/250V - 16 A - IP67 (IEC 309) - for powers up to 3450W	

ACCESSORI / ACCESSORIES	PREZZO / PRICE	DESCRIZIONE / DESCRIPTION	PER / FOR
A10	€ 39,00	Griglia liscia 1/1 GN / 1/1 GN Flat	Tutti gli articoli All Articles
A20	€ 46,00	Griglia asolata 1/1 GN / 1/1 GN Perforated	

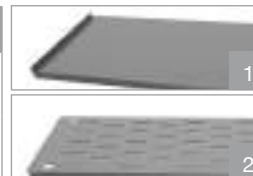

- Vasca in acciaio inox AISI 304 profonda cm 19 per bacinelle GN fino a cm 15 h (escluse)
 - Scarico acqua bagnomaria (optional carico acqua da rete e troppopieno)
 - Riscaldamento a umido-bagnomaria con resistenza esterna alla vasca
 - Pannello comandi con termostato-termometro digitale e interruttori di accensione con spia luminosa
 - Tensione rete 230 Volt monofase-50/60 Hz (optional 380 Volt trifase)
 - Cavo spiralato lunghezza 3mt., spina Schuko Per potenze uguali o superiori a 3000W, il cavo viene fornito libero senza spina.
- AISI 304 stainless steel well 19 cm deep for GN containers up to 15 cm high (excluded)
 - Bain-marie water drain (optional water supply from the mains and overflow)
 - Bain-marie heating with heating element outside the well
 - Control panel with digital thermostat-thermometer and ON/OFF switch with warning light
 - Mains supply: 230V, - 50/60 Hz, single-phase (optional 380V three-phase)
 - 3m long spiral cable, Schuko plug. For powers equal to or greater than 3000W, the cable is supplied free without plug.

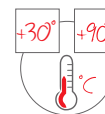

Optional bacinelle vedi pag. 78-79
Optional Gastronorms: see pp. 78-79

Art. 6990.4B + A20(x4)







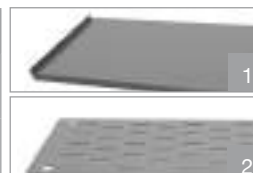

ARTICOLO / ARTICLE	PREZZO / PRICE	GN	DESCRIZIONE / DESCRIPTION	POTENZA / POWER	MAX DIM. CM
6990.2B	€ 1.289,00	2x1/1	Solo vasca Well only	1200W	80x68x22 h
6990.3B	€ 1.548,00	3x1/1		1500W	113x68x22 h
6990.4B	€ 1.849,00	4x1/1		2400W	161x68x22 h
6990.5B	€ 2.187,00	5x1/1		3000W	193x68x22 h
6990.6B	€ 2.570,00	6x1/1		3600W	226x68x22 h

OPTIONAL	PREZZO / PRICE	DESCRIZIONE / DESCRIPTION	PER / FOR
A152	€ 272,00	Alimentazione 380 V / Mains supply 380V	Tutti gli articoli All Articles
A154	€ 219,00	Carico acqua da rete e scarico con rubinetto e troppopieno / Water loading from net, drain tap and overflow	
T200	€ 57,00	Spina mobile 2P+T-6h/250V - 16 A - IP67 (IEC 309) - per potenze fino a 3450W Mobile plug 2P+E-6h/250V - 16 A - IP67 (IEC 309) - for powers up to 3450W	

ACCESSORI / ACCESSORIES	PREZZO / PRICE	DESCRIZIONE / DESCRIPTION	PER / FOR
A10	€ 39,00	Griglia liscia 1/1 GN / 1/1 GN Flat	Tutti gli articoli All Articles
A20	€ 46,00	Griglia asolata 1/1 GN / 1/1 GN Perforated	





	CESTONI PORTABIANCHERIA <i>LINEN TRUCKS</i>	PAG. 182
	ROLL CONTAINER <i>ROLL CONTAINERS</i>	PAG. 184
	ARMADI SPOGLIATOIO E PORTASCOPE <i>CHANGING ROOM AND BROOM LOCKERS</i>	PAG. 188
	SCAFFALATURE COMPONENTI <i>MODULAR SHELVING SYSTEMS</i>	PAG. 200
	PATTUMIERE IN ACCIAIO INOX <i>STAINLESS STEEL WASTE BINS</i>	PAG. 194
	PORTAROTOLI <i>PAPER TOWEL DISPENSERS</i>	PAG. 195
	LAVAMANI <i>HAND WASHERS</i>	PAG. 196
	CARRELLI A PIANALE ESTENSIBILI <i>EXTENSIBLE PLATFORM TRUCKS</i>	PAG. 198
	PORTACASSE <i>PLATFORM TRUCKS</i>	PAG. 199

CESTONI PORTABIANCHERIA LINEN TRUCKS

- Struttura pieghevole in tondino di acciaio plastificato bianco (Art. 1500)
- Struttura pieghevole in tubo e filo di acciaio verniciato bianco (Art. 1505 - 1510)
- Ruote piroettanti di diametro differente (a seconda del modello)

- *White plastic-coated steel tube foldable structure (Art. 1500)*
- *White painted steel tube and wire foldable structure (Art. 1505-1510)*
- *Swivel wheels - various diameters available (depending on the model)*

SOLO PER USO INTERNO
E PAVIMENTAZIONI PIANE
*INDOOR USE
AND FLAT FLOORS ONLY*



Art. 1500 + R0020



Art. 1505 chiuso
Art. 1505 folded

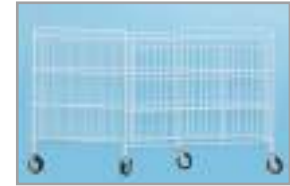

Art. 1500 chiuso
Art. 1500 folded



Art. 1505



Art. 1510

ARTICOLO / ARTICLE	PREZZO / PRICE	Ø CM RUOTE / WHEELS	PER / FOR
1500	€ 158,00	8	80x51x75 h
1505	€ 368,00	9,5	80x52x77 h
1510	€ 381,00		100x60x87 h

OPTIONAL	PREZZO / PRICE	DESCRIZIONE / DESCRIPTION	PER / FOR
R0020	€ 112,00	Sacco portabiancheria in tela Canvas bag for dirty linen	1500 - 1505
R0030	€ 135,00		1510



1

CESTONI PORTABIANCHERIA IN POLIPROPILENE
POLYPROPYLENE LINEN TRUCKS

- Struttura in tubolari di polipropilene montati ad innesto
- Ruote di diametro differente a seconda del modello, montate su un telaio in acciaio zincato
- *Structure made of polypropylene snap-in tubes*
- *Wheels mounted onto a galvanized steel frame (various diameters available depending on the model)*



Art. 15502



Art. 15508



Art. 15500

ARTICOLO / ARTICLE	PREZZO / PRICE	Ø CM RUOTE / WHEELS	MAX DIM. CM	IMBALLO / PACKAGING
15500	€ 1.204,00	12,5	134x75x84 h	ATTENZIONE: IMBALLO CON PELLICOLA TRASPARENTE NOTE: PACKAGING WITH TRANSPARENT FILM
15502	€ 870,00	10	102x63x82,5 h	
15508	€ 578,00	8	83x48x79,5 h	

ROLL CONTAINER ROLL CONTAINERS

- Carrello roll container, composto da una base su ruote, 3 sponde fisse
- Struttura in acciaio inox AISI 304 completamente saldata
- Ripiano intermedio asportabile (art. 1833)
- Ruote piroettanti ø cm 16, 2 fisse, 2 piroettanti con freno, supporto zincato, anello in gomma grigia antitraccia, rotolamento su cuscinetti



- Roll container composed of 1 wheeled platform and 3 fixed side frames
- Welded AISI 304 stainless steel construction
- Removable central shelf (art. 1833)
- 2 fixed and 2 braked swivel castors with heavy-duty brackets, ø 16 cm, grey non marking rubber tread on centre with roller bearing hub



Art. 1832



Art. 1833

ARTICOLO / ARTICLE	PREZZO / PRICE	DESCRIZIONE / DESCRIPTION	MAX DIM. CM	IMBALLO / PACKAGING
1832	€ 1.353,00	1 Base + 3 sponde 1 Platform + 3 side frames	145x65x198 h	ATTENZIONE: IMBALLO CON PELLICOLA TRASPARENTE NOTE: PACKAGING WITH TRANSPARENT FILM
1833	€ 1.598,00	1 Base + 3 sponde + 1 ripiano intermedio 1 Platform + 3 side frames + 1 central shelf		

OPTIONAL	PREZZO / PRICE	DESCRIZIONE / DESCRIPTION	PER / FOR
E	€ 97,00	Set 2 ruote con freno Set with 2 braked castors	Tutti gli articoli All Articles
EINOX	€ 200,00	Set 4 ruote elastiche, di cui 2 con freno Set with 4 resilient castors, 2 with brake	



ROLL CONTAINER ANTIFURTO
ANTI-THEFT ROLL CONTAINERS

- Carrello roll container antifurto sicurezza, composto da 1 base su ruote, 4 pareti (parete anteriore apribile a 270°) e cappello superiore
- Telaio in tubo quadro (maglia cm 5x5) BREVETTATO che, fissato alla base e tramite viti e dadi, costituisce una struttura rigida, robusta e inviolabile
- Possibilità di bloccare la porta anteriore con sigilli o tradizionali lucchetti
- Ruote in polipropilene ø cm 10,6, di cui 2 piroettanti rosse e 2 fisse nere



- *Safety anti-theft roll container composed of a wheeled platform, 4 side frames (4th side opening to 270°) and closing lid*
- *PATENTED square tube frame (mesh cm 50x50) fixed to the base by screws and nuts, representing an inviolable rigid and safe structure*
- *The front doors can be locked by seals or padlocks*
- *Polypropylene castors, ø 10.6 cm - 2 swivel (red) and 2 fixed (black)*



Art. 1815



ARTICOLO / ARTICLE	PREZZO / PRICE	DESCRIZIONE / DESCRIPTION	MAX DIM. CM	IMBALLO / PACKAGING
1815	€ 609,00	1 Base + 4 pareti e cappello superiore <i>1 Platform + 4 sides and closing lid</i>	70x80x180 h	ATTENZIONE: IMBALLO CON PELLICOLA TRASPARENTE NOTE: PACKAGING WITH TRANSPARENT FILM
ACCESSORI / ACCESSORIES	PREZZO / PRICE	DESCRIZIONE / DESCRIPTION	PER / FOR	
A18124	€ 37,00	1 Ripiano intermedio standard <i>Standard intermediate shelf</i>		

ROLL CONTAINER ROLL CONTAINERS

- Carrello roll container, composto da 1 base su ruote, 2 sponde laterali e 2 cinghie
- Telaio in tubo e tondini trattati con zincatura elettrolitica brillante
- Ruote in polipropilene ø cm 10,6, di cui 2 piroettanti rosse e 2 fisse nere



- Roll container composed of a wheeled platform, 2 side frames and 2 straps
- Bright zinc electroplated tubular frame and reinforcing bars
- Polypropylene castors, ø 10.6 cm - 2 swivel (red) and 2 fixed (black)



Art. 1812



Art. 1812 + A18122 + A18123

ARTICOLO / ARTICLE	PREZZO / PRICE	DESCRIZIONE / DESCRIPTION	MAX DIM. CM	IMBALLO / PACKAGING
1812	€ 249,00	1 Base + 2 sponde laterali + 2 cinghie <i>1 Platform + 2 side frames + 2 straps</i>	72x81x180 h	ATTENZIONE: IMBALLO CON PELLICOLA TRASPARENTE NOTE: PACKAGING WITH TRANSPARENT FILM

ACCESSORI / ACCESSORIES	PREZZO / PRICE	DESCRIZIONE / DESCRIPTION	PER / FOR
A18121	€ 8,00	Cinghia in nylon <i>Additional nylon strap</i>	Tutti gli articoli <i>All Articles</i>
A18122	€ 71,00	Sponda posteriore <i>Rear wall</i>	
A18123	€ 96,00	Sportello anteriore apribile a 2/3 <i>Front opening 2/3</i>	
A18124	€ 37,00	Ripiano intermedio (max n.3) <i>Shelf (max. 3 shelves)</i>	
A18127	€ 216,00	Rivestimento in PVC con cerniere <i>PVC covering with zips</i>	

- Carrello roll container, composto da 1 base su ruote, 2 sponde laterali e 1 cinghia
- Struttura in tubo e tondini trattati con zincatura elettrolitica brillante
- Ruote in polipropilene ø cm 10,6, di cui 2 piroettanti rosse e 2 fisse nere



- Roll container composed of a wheeled platform, 2 side frames and 1 strap
- Bright zinc electroplated tubular frame and reinforcing bars
- Polypropylene castors, ø 10.6 cm - 2 swivel (red) and 2 fixed (black)



Art. 1826 + A18263



Art. 1826 + A18263 + A18264

ARTICOLO / ARTICLE	PREZZO / PRICE	DESCRIZIONE / DESCRIPTION	MAX DIM. CM	IMBALLO / PACKAGING
1826	€ 315,00	1 Base + 2 sponde laterali + 1 cinghia 1 Platform + 2 side frames + 1 strap	72x81x180 h	<p>ATTENZIONE: IMBALLO CON PELLICOLA TRASPARENTE</p> <p>NOTE: PACKAGING WITH TRANSPARENT FILM</p>

ACCESSORI / ACCESSORIES	PREZZO / PRICE	DESCRIZIONE / DESCRIPTION	PER / FOR
A18262	€ 8,00	Cinghia in nylon Additional nylon strap	Tutti gli articoli All Articles
A18263	€ 94,00	Sponda posteriore Rear wall	
A18264	€ 113,00	Sportello anteriore apribile a 2/3 Front opening 2/3	
A18261	€ 74,00	Ripiano intermedio (max n.3) Shelf (max. 3 shelves)	

ARMADI SPOGLIATOIO CHANGING ROOM LOCKERS

- Armadio spogliatoio in lamiera di acciaio inox AISI 430
- Tetto inclinato
- Gancio appendiabiti
- Divisorio interno sporco/pulito
- Sportello a battente con serratura a chiave
- Ripiani porta scarpe e porta cappello
- Piedini regolabili

- *AISI 430 stainless steel sheet changing room locker*
- *Sloping roof*
- *Clothes hook*
- *Internal partition and shelves*
- *Lockable doors*
- *Shoe and hat racks*
- *Adjustable feet*



Art. 9440



Art. 9442



Art. 9444

ARTICOLO / ARTICLE	PREZZO / PRICE	DESCRIZIONE / DESCRIPTION	MAX DIM. CM
9440	€ 1.103,00	Singolo Single locker	50x40x215 h
9442	€ 1.908,00	Biposto 2-Door locker	95x40x215 h
9444	€ 2.100,00	Quattro posti 4-Door locker	

- Armadio porta scope in lamiera di acciaio inox AISI 430
- Tetto inclinabile
- Divisorio interno parziale e 3 ripiani regolabili
- Sportello/i a battente con serratura a chiave
- Piedini regolabili

- *AISI 430 stainless steel sheet broom locker*
- *Sloping roof*
- *Internal partial partition, 3 adjustable shelves*
- *Lockable doors*
- *Adjustable feet*



Art. 9460



Art. 9462

ARTICOLO / ARTICLE	PREZZO / PRICE	DESCRIZIONE / DESCRIPTION	MAX DIM. CM
9460	€ 1.190,00	1 anta <i>1-Door locker</i>	50x40x215 h
9462	€ 1.803,00	2 ante <i>2-Door locker</i>	95x40x215 h

SCAFFALATURE COMPONENTI - MONTAGGIO A INCASTRO MODULAR SHELVING SYSTEMS

- Montanti in tubo tondo di acciaio inox AISI 304 \varnothing cm 4 con tacche di riferimento per la regolazione ogni 10 cm in altezza dei piani
- Piani realizzati in lamiera di acciaio inox dotati di supporti angolari in materiale plastico, con bordi scatolati antitaglio in versione liscia o asolata
- Piedini regolabili per il livellamento
- Piani normali: portata kg 100/mt
- Piani rinforzati: portata kg 150/mt
- Piani agganciati in continuo: portata kg 100/mt
- Elementi di aggancio per consentire il montaggio dei piani in continuo o in angolo



- *AISI 304 stainless steel round posts, \varnothing 4 cm, with notches every 10 cm for easy shelf placement*
- *Stainless steel sheet solid or perforated shelves with plastic angle supports and safety edges to eliminate sharpness*
- *Adjustable level feet*
- *Normal shelves: 100 kg/m load capacity*
- *Reinforced shelves: 150 kg/m load capacity*
- *Shelves for continuous run systems: 100 kg/m load capacity*
- *Hooks for continuous runs of shelving and "L"- shaped shelving units*

A RICHIESTA È POSSIBILE REALIZZARE RIPIANI A MISURA
NOTE: CUSTOM MADE SHELF DIMENSIONS UPON REQUEST



Piano Liscio
Solid shelf



Piano Asolato
Perforated shelf

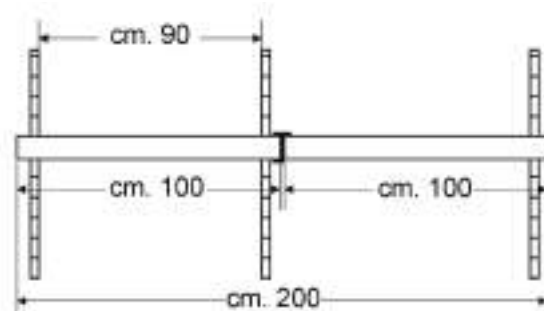
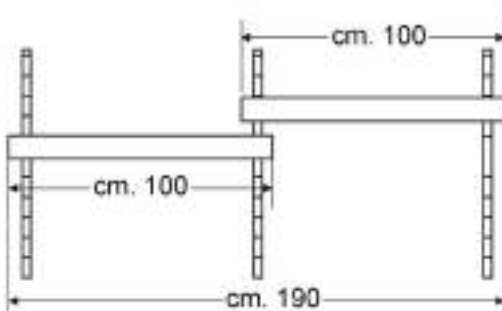

SCAFFALATURE COMPONENTI - MONTAGGIO A INCASTRO
MODULAR SHELVING SYSTEMS

PIANI LISCI - PORTATA KG 100/MT SOLID SHELVES - CAPT 100 KG/M		
ARTICOLO / ARTICLE	PREZZO / PRICE	MAX DIM. CM
PLI3080	€ 65,00	80x30
PLI3090	€ 70,00	90x30
PLI30100	€ 75,00	100x30
PLI30110	€ 78,00	110x30
PLI30120	€ 84,00	120x30
PLI4080	€ 73,00	80x40
PLI4090	€ 78,00	90x40
PLI40100	€ 85,00	100x40
PLI40110	€ 90,00	110x40
PLI40120	€ 96,00	120x40
PLI5080	€ 83,00	80x50
PLI5090	€ 88,00	90x50
PLI50100	€ 93,00	100x50
PLI50110	€ 101,00	110x50
PLI50120	€ 108,00	120x50
PLI6080	€ 90,00	80x60
PLI6090	€ 97,00	90x60
PLI60100	€ 103,00	100x60

PIANI ASOLATI - PORTATA KG 100/MT PERFORATED SHELVES - CAPT 100 KG/M		
ARTICOLO / ARTICLE	PREZZO / PRICE	MAX DIM. CM
PAI3080	€ 67,00	80x30
PAI3090	€ 71,00	90x30
PAI30100	€ 76,00	100x30
PAI30110	€ 83,00	110x30
PAI30120	€ 86,00	120x30
PAI4080	€ 75,00	80x40
PAI4090	€ 83,00	90x40
PAI40100	€ 88,00	100x40
PAI40110	€ 93,00	110x40
PAI40120	€ 100,00	120x40
PAI5080	€ 86,00	80x50
PAI5090	€ 92,00	90x50
PAI50100	€ 99,00	100x50
PAI50110	€ 107,00	110x50
PAI50120	€ 113,00	120x50
PAI6080	€ 94,00	80x60
PAI6090	€ 102,00	90x60
PAI60100	€ 111,00	100x60

MONTANTI TUBO Ø CM 3 - PIEDINI REGOLABILI ROUND POSTS, Ø 3 CM - ADJUSTABLE FEET		
ARTICOLO / ARTICLE	PREZZO / PRICE	MAX DIM. CM
MT150	€ 48,00	150
MT180	€ 50,00	180
MT200	€ 56,00	200

ACCESSORI ACCESSORIES		
ARTICOLO / ARTICLE	PREZZO / PRICE	DESCRIZIONE / DESCRIPTION
PAG001	€ 7,00	Aggancio per piani / Hooks

PIANI LISCI RINF. - PORTATA KG 150/MT REINF SOLID SHELVES - CAPT 150 KG/M		
ARTICOLO / ARTICLE	PREZZO / PRICE	MAX DIM. CM
PLIR30100	€ 103,00	100x30
PLIR30110	€ 111,00	110x30
PLIR30120	€ 116,00	120x30
PLIR30130	€ 121,00	130x30
PLIR30140	€ 127,00	140x30
PLIR40100	€ 114,00	100x40
PLIR40110	€ 120,00	110x40
PLIR40120	€ 128,00	120x40
PLIR40130	€ 135,00	130x40
PLIR40140	€ 140,00	140x40
PLIR50100	€ 123,00	100x50
PLIR50110	€ 132,00	110x50
PLIR50120	€ 140,00	120x50
PLIR50130	€ 147,00	130x50
PLIR50140	€ 154,00	140x50
PLIR60100	€ 134,00	100x60
PLIR60110	€ 143,00	110x60
PLIR60120	€ 152,00	120x60
PLIR60130	€ 161,00	130x60
PLIR60140	€ 169,00	140x60

PIANI ASOLATI - PORTATA KG 100/MT REINF PERFORATED SHELVES - CAPT 150 KG/M		
ARTICOLO / ARTICLE	PREZZO / PRICE	MAX DIM. CM
PAIR30100	€ 107,00	100x30
PAIR30110	€ 113,00	110x30
PAIR30120	€ 119,00	120x30
PAIR30130	€ 124,00	130x30
PAIR30140	€ 132,00	140x30
PAIR40100	€ 118,00	100x40
PAIR40110	€ 124,00	110x40
PAIR40120	€ 132,00	120x40
PAIR40130	€ 140,00	130x40
PAIR40140	€ 148,00	140x40
PAIR50100	€ 128,00	100x50
PAIR50110	€ 138,00	110x50
PAIR50120	€ 145,00	120x50
PAIR50130	€ 153,00	130x50
PAIR50140	€ 162,00	140x50
PAIR60100	€ 139,00	100x60
PAIR60110	€ 148,00	110x60
PAIR60120	€ 158,00	120x60
PAIR60130	€ 167,00	130x60
PAIR60140	€ 175,00	140x60

SCAFFALATURE COMPONENTI - MONTAGGIO A BULLONE MODULAR SHELVING SYSTEMS

- Montanti in lamiera di acciaio inox AISI 304 cm 3,5x3,5 piegati a " L "
- Piani realizzati in lamiera di acciaio inox con bordi scistolati antitaglio in versione liscia o asolata
- Bulloneria inox inclusa
- Piedini regolabili (optional)
- Piani normali: portata Kg 100/mt
- Piani rinforzati: portata Kg 150/mt

- *AISI 304 stainless steel sheet "L"- shaped posts, 3.5x3.5 cm*
- *Solid or perforated shelves in stainless steel sheet with safety edges to eliminate sharpness*
- *Stainless steel bolts included*
- *Optional adjustable feet*
- *Normal shelves: 100 kg/m load capacity*
- *Reinforced shelves: 150 kg/m load capacity*



A RICHIESTA È POSSIBILE REALIZZARE RIPIANI A MISURA
NOTE: CUSTOM MADE SHELF DIMENSIONS UPON REQUEST



SCAFFALATURE COMPONENTI - MONTAGGIO A BULLONE
MODULAR SHELVING SYSTEMS

PIANI LISCI - PORTATA KG 100/MT SOLID SHELVES - CAPT 100 KG/M		
ARTICOLO / ARTICLE	PREZZO / PRICE	MAX DIM. CM
PLB3080	€ 52,00	80x30
PLB3090	€ 59,00	90x30
PLB30100	€ 64,00	100x30
PLB30110	€ 67,00	110x30
PLB30120	€ 71,00	120x30
PLB4080	€ 61,00	80x40
PLB4090	€ 67,00	90x40
PLB40100	€ 74,00	100x40
PLB40110	€ 77,00	110x40
PLB40120	€ 85,00	120x40
PLB5080	€ 70,00	80x50
PLB5090	€ 76,00	90x50
PLB50100	€ 83,00	100x50
PLB50110	€ 90,00	110x50
PLB50120	€ 96,00	120x50
PLB6080	€ 77,00	80x60
PLB6090	€ 86,00	90x60
PLB60100	€ 92,00	100x60
PLB60110	€ 100,00	110x60
PLB60120	€ 108,00	120x60

PIANI ASOLATI - PORTATA KG 100/MT PERFORATED SHELVES - CAPT 100 KG/M		
ARTICOLO / ARTICLE	PREZZO / PRICE	MAX DIM. CM
PAB3080	€ 57,00	80x30
PAB3090	€ 60,00	90x30
PAB30100	€ 65,00	100x30
PAB30110	€ 70,00	110x30
PAB30120	€ 74,00	120x30
PAB4080	€ 64,00	80x40
PAB4090	€ 70,00	90x40
PAB40100	€ 76,00	100x40
PAB40110	€ 83,00	110x40
PAB40120	€ 88,00	120x40
PAB5080	€ 74,00	80x50
PAB5090	€ 81,00	90x50
PAB50100	€ 87,00	100x50
PAB50110	€ 94,00	110x50
PAB50120	€ 101,00	120x50
PAB6080	€ 84,00	80x60
PAB6090	€ 91,00	90x60
PAB60100	€ 99,00	100x60
PAB60110	€ 107,00	110x60
PAB60120	€ 113,00	120x60

MONTANTI ANGOLARI CM 3,5X3,5 "L"-SHAPED POSTS 3.5X3.5 CM		
ARTICOLO / ARTICLE	PREZZO / PRICE	MAX DIM. CM
MA100	€ 26,00	100
MA130	€ 32,00	130
MA150	€ 33,00	150
MA180	€ 39,00	180
MA200	€ 42,00	200

ACCESSORI ACCESSORIES		
ARTICOLO / ARTICLE	PREZZO / PRICE	DESCRIZIONE / DESCRIPTION
PR001	€ 15,00	Piedino regolabile / Adjustable support foot

PIANI LISCI RINF. - PORTATA KG 150/MT REINF SOLID SHELVES - CAPT 150 KG/M		
ARTICOLO / ARTICLE	PREZZO / PRICE	MAX DIM. CM
PLBR30100	€ 92,00	100x30
PLBR30110	€ 100,00	110x30
PLBR30120	€ 104,00	120x30
PLBR30130	€ 111,00	130x30
PLBR30140	€ 117,00	140x30
PLBR40100	€ 102,00	100x40
PLBR40110	€ 111,00	110x40
PLBR40120	€ 118,00	120x40
PLBR40130	€ 123,00	130x40
PLBR40140	€ 129,00	140x40
PLBR50100	€ 112,00	100x50
PLBR50110	€ 121,00	110x50
PLBR50120	€ 129,00	120x50
PLBR50130	€ 137,00	130x50
PLBR50140	€ 144,00	140x50
PLBR60100	€ 121,00	100x60
PLBR60110	€ 130,00	110x60
PLBR60120	€ 141,00	120x60
PLBR60130	€ 148,00	130x60
PLBR60140	€ 158,00	140x60

PIANI ASOLATI - PORTATA KG 100/MT REINF PERFORATED SHELVES - CAPT 150 KG/M		
ARTICOLO / ARTICLE	PREZZO / PRICE	MAX DIM. CM
PABR30100	€ 94,00	100x30
PABR30110	€ 100,00	110x30
PABR30120	€ 104,00	120x30
PABR30130	€ 113,00	130x30
PABR30140	€ 120,00	140x30
PABR40100	€ 107,00	100x40
PABR40110	€ 113,00	110x40
PABR40120	€ 119,00	120x40
PABR40130	€ 128,00	130x40
PABR40140	€ 138,00	140x40
PABR50100	€ 117,00	100x50
PABR50110	€ 124,00	110x50
PABR50120	€ 129,00	120x50
PABR50130	€ 141,00	130x50
PABR50140	€ 150,00	140x50
PABR60100	€ 127,00	100x60
PABR60110	€ 135,00	110x60
PABR60120	€ 143,00	120x60
PABR60130	€ 155,00	130x60
PABR60140	€ 166,00	140x60

PATTUMIERE IN ACCIAIO INOX AISI 304 AISI 304 STAINLESS STEEL WASTE BINS

- Pattumiera in acciaio inox AISI 304, finitura spazzolata
- Fondo stampato raggiato a tenuta stagna, privo di spigoli
- Coperchio con apertura manuale o a pedale (a seconda del modello)
- Montata su ruote

- *AISI 304 stainless steel waste bin, brushed finish*
- *Watertight radial pressed bottom with no sharp edges*
- *Manual or pedal operated opening (depending on the model)*
- *Wheel-mounted*



Fondo
a tenuta stagna
Watertight
pressed bottom

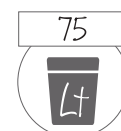
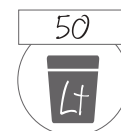

Art. 2175PM



Art. 2190PP



Coperchio agganciabile
Hanging lid



Apertura a pedale
Pedal operated opening

ARTICOLO / ARTICLE	PREZZO / PRICE	APERTURA COPERCHIO / OPENING	CAPACITÀ LT / LT CAPACITY	MAX DIM. CM
2150PM	€ 263,00	Manuale <i>Manual</i>	50	ø 39x61 h
2175PM	€ 298,00		75	ø 45x61 h
2190PM	€ 319,00		90	ø 45x69 h
2150PP	€ 354,00	Pedale <i>Pedal operated</i>	50	ø 39x61 h
2175PP	€ 392,00		75	ø 45x61 h
2190PP	€ 413,00		90	ø 45x69 h

- Portarotolo carta verticale a muro in acciaio inox satinato con svolgimento interno
- *Stainless steel wall-mounted vertical paper towel dispenser with internal unwinding, satin finish*



Art. 2604

- Portarotolo carta orizzontale a muro in acciaio inox satinato
- *Stainless steel wall-mounted horizontal paper towel dispenser, satin finish*







Art. 2608

- Distributore a muro di carta asciugamani in rotolo in acciaio inox
- *Stainless steel wall-mounted paper towel roll holder*



Art. 2603

ARTICOLO / ARTICLE	PREZZO / PRICE	DESCRIZIONE / DESCRIPTION	MAX DIM. CM				
2604	€ 181,00	Portarotolo carta verticale <i>Vertical paper towel dispenser</i>	ø 25x32 h	3	M	28x28x40 h	4
2608	€ 208,00	Portarotolo carta orizzontale <i>Horizontal paper towel dispenser</i>	ø 30x33 h				
2603	€ 110,00	Distributore carta asciugamani <i>Paper towel roll holder</i>	38x17x26 h	1		41x20x29 h	2

LAVAMANI HAND WASHERS

- Lavamani in acciaio inox AISI 304
- Rubinetti e scarichi inclusi
- *AISI 304 stainless steel hand washers*
- *Tap and drain included*

Art. 9480-4040



Art. 9482-4836



Art. 9483-4836



semicircolare
semicircular

semicircolare
semicircular

ARTICOLO / ARTICLE	PREZZO / PRICE	DESCRIZIONE / DESCRIPTION	MAX DIM. CM
9480-4040	€ 377,00	Lavamani a parete con alzatina h 3 cm con comando a "ginocchio" <i>Wall mounted hand washer with 3 cm-high raised edge with "knee" control</i>	40x40x27 h
9482-4836	€ 476,00	Lavamani semicircolare a parete con alzatina h 30 cm con comando a "ginocchio" <i>Wall mounted semicircular hand washer with 30 cm-high raised edge with "knee" control</i>	48x36x52 h
9483-4836	€ 413,00	Lavamani a parete con alzatina h 4 cm con comando a "ginocchio" <i>Wall mounted hand washer with 4 cm-high raised edge with "knee" control</i>	48x35x26 h
9484-4040	€ 420,00	Lavamani a colonna con comando a "ginocchio" <i>Free-standing hand washer with "knee" control</i>	40x40x80 h
9484-5040	€ 529,00		50x40x80 h
9484-5050	€ 571,00		50x50x80 h
9487-4040	€ 756,00	Lavamani su mobile con alzatina h 10 cm, porta a battente e sifone incluso <i>Hand washer on cabinet, with 10 cm-high raised edge, hinged door and siphon included</i>	40x40x95 h
9487-5040	€ 805,00		50x40x95 h
9487-5050	€ 868,00		50x50x95 h



Art. 9484-5040



Art. 9487-5040

CARRELLI A PIANALE ESTENSIBILI
EXTENSIBLE PLATFORM TRUCKS

- Struttura in tubolare quadrato inox 2,5x2,5 cm
- Paracolpi in gomma grigia agli angoli
- Ruote ø cm 12,5, 2 fisse e 2 piroettanti con freno, anello in gomma grigia antitraccia, rotolamento su cuscinetti



- *Stainless steel 2.5x2.5 cm square tube structure*
- *Grey rubber bumpers at the corners*
- *Castors, ø cm 12.5, 2 fixed and 2 swivel with brake, grey non marking rubber tread on centre with roller bearing hub*



Art. 1899

ARTICOLO / ARTICLE	PREZZO / PRICE	MAX DIM. CM APERTO / OPEN		MAX DIM. CM CHIUSO / CLOSED
1899	€ 870,00	con pianale esteso <i>with extended platform</i>	159x60x88 h	110x60x26 h
		con pianale chiuso <i>with unextended platform</i>	110x60x88 h	

- Base in lamiera di acciaio inox AISI 304
- 1 o 2 manici in tubo inox (a seconda del modello)
- Ruote ø cm 12,5, 2 fisse e 2 piroettanti, anello in gomma grigia antitraccia, rotolamento su cuscinetti



- AISI 304 stainless steel sheet platform
- 1 or 2 stainless steel tube handles (depending on the model)
- 2 Fixed and 2 swivel castors, ø 12.5 cm, grey non marking rubber tread on centre with roller bearing hub



Art. 1895



Art. 1897-F



Art. 1897M2-F

ARTICOLO / ARTICLE	PREZZO / PRICE	DESCRIZIONE / DESCRIPTION	DIM CM PIANO / PLATFORM	MAX DIM. CM
1895	€ 295,00	1 manico 1 pushing handle	60x60	60x70x97 h
1896	€ 376,00		60x80	60x90x97 h
1897	€ 417,00		60x100	60x110x97 h
1895M2	€ 348,00	2 manici 2 pushing handles	60x60	60x80x97 h
1896M2	€ 436,00		60x80	60x100x97 h
1897M2	€ 478,00		60x100	60x120x97 h

OPTIONAL	PREZZO / PRICE	IMMAGINE	DESCRIZIONE / DESCRIPTION	PER / FOR	IMMAGINE
F	€ 49,00	1	Set 2 ruote con freno Set with 2 braked castors	Tutti gli articoli All Articles	1

PORTACASSE IN POLIETILENE POLYETHYLENE PLATFORM TRUCKS

- Base in polietilene
- Manico in tubo inox fisso o pieghevole (a seconda del modello)
- Ruote ø cm 12,5, 2 fisse e 2 piroettanti, anello in gomma grigia antitraccia, rotolamento su cuscinetti
- Polyethylene base
- Fixed or folding handle in stainless steel tube (depending on the model)
- 2 Fixed and 2 swivel castors, ø 12.5 cm, grey non marking rubber tread on centre with roller bearing hub



PUÒ ESSERE UTILIZZATO IN AMBIENTI ESTERNI

NOTE: SUITABLE FOR OUTDOOR USE



Art. 1840

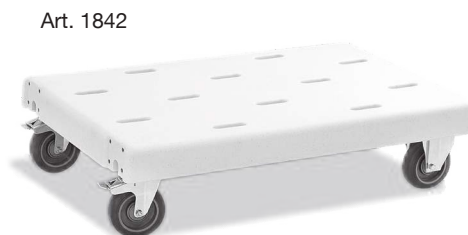

Art. 1842



Art. 1841 chiuso/folded

- Pianale in filo di acciaio trattato con zincatura elettrolitica brillante
- Ruote piroettanti in polipropilene ø cm 10,6

- Bright zinc electroplated steel mesh platform
- Polypropylene swivel castors, ø 10.6 cm



Art. 1836

ARTICOLO / ARTICLE	PREZZO / PRICE	MANICO / PUSH HANDLE	DESCRIZIONE / DESCRIPTION	MAX DIM. CM	IMBALLO / PACKAGING
1842	€ 268,00	-	Senza manico No pushing handle	92x57x27 h	ATTENZIONE: IMBALLO CON PELLICOLA TRASPARENTE NOTE: PACKAGING WITH TRANSPARENT FILM
1840	€ 312,00	1	Manico fisso in tubo tondo di acciaio inox ø cm 2,5 Stainless steel rigid round tube handle ø 2.5 cm	107x57x97 h	
1841	€ 341,00	1	Manico pieghevole in tubo quadro di acciaio inox cm 2,5x2,5 Stainless steel folding square tube handle 2.5x2.5 cm	95x57x87 h	
1840M2	€ 362,00	2	Manici fissi in tubo tondo inox ø cm 2,5 Stainless steel rigid round tube handles ø 2.5 cm	107x57x97 h	
1836	€ 98,00	-	Senza manico No pushing handle	62x41x16 h	

OPTIONAL	PREZZO / PRICE	IMMAGINE	DESCRIZIONE / DESCRIPTION	PER / FOR	IMMAGINE
F	€ 49,00	1	Set 2 ruote con freno Set with 2 braked castors	Tutti gli articoli tranne art. 1836 All Articles except art. 1836	1

- Impugnatura di sicurezza
- Pala di carico: 250 x 270 mm
- Larghezza totale: 580 x h.1210 mm
- Ruote pneumatiche ø cm 26 con dischi in acciaio



- *Safety handle*
- *Loading blade: 250 x 270 mm*
- *Overall width: 580 x h.1210 mm*
- *Pneumatic wheels ø cm 26 with steel discs*



Art. 1891A

ARTICOLO / ARTICLE	PREZZO / PRICE	DESCRIZIONE / DESCRIPTION	MAX DIM. CM
1891A	€ 207,00	Carrello per trasporto casse e scatole colore rosso <i>Red trolley for transporting crates and boxes</i>	58x121 h



	STENDER E CARRELLI PORTABITI E PORTABAGAGLI <i>LUGGAGE CART AND GARMENT RAILS</i>	PAG. 204
	CARRELLI PORTABAGAGLI <i>LUGGAGE HANDTRUCKS</i>	PAG. 207
	REGGIVALIGIE <i>LUGGAGE RACKS</i>	PAG. 209
	CARRELLI PER IL SERVIZIO IN CAMERA E CASSETTE TERMICHE <i>ROOM SERVICE TABLES AND FOOD WARMERS</i>	PAG. 210
	CARRELLI RIFORMIMENTO MINIBAR <i>MINIBAR RESTOCKING CUPBOARD TROLLEY</i>	PAG. 214
	CARRELLI PORTABIANCHERIA <i>CHAMBERMAID TROLLEYS</i>	PAG. 215
	CARRELLI PORTABIANCHERIA ARMADIATI <i>HOUSEKEEPING CUPBOARD TROLLEYS</i>	PAG. 219
	PATTUMIERE PORTASACCO <i>WASTE BINS AND SACK-HOLDERS</i>	PAG. 221
	SVUOTAVASSOI <i>FAST-FOOD BINS</i>	PAG. 222
	PATTUMIERE PER LA RACCOLTA DIFFERENZIATA <i>RECYCLING BINS</i>	PAG. 223
	PATTUMIERE GETTACARTE PICCOLE <i>SMALL WASTE/PAPER BINS</i>	PAG. 226
	GETTACARTE <i>PAPER BINS</i>	PAG. 227
	POSACENERE / GETTACARTE <i>ASHTRAY TOP PAPER BINS</i>	PAG. 228
	PORTAOMBRELLI <i>UMBRELLA STANDS</i>	PAG. 229

STENDER PORTABITI - PORTABAGAGLI LUGGAGE CART WITH GARMENT RAIL

- Struttura appendiabiti in tubo di acciaio inox AISI 304
- Base in lamiera di acciaio inox AISI 304
- Maniglioni laterali di spinta
- Anelli paracolpi in gomma grigia agli angoli
- Ruote piroettanti ø cm 12,5

- *AISI 304 stainless steel tube garment rail structure*
- *AISI 304 stainless steel sheet deck*
- *Side pushing bars*
- *Grey rubber bumper rings at corners*
- *Swivel castors, ø 12.5 cm*



Art. 1795

- Stender in acciaio cromato
- Struttura facilmente smontabile
- Prolunghe laterali estraibili lunghe 40 cm cad. (240 cm totali)
- Ruote piroettanti ø cm 8

- *Easily demountable chrome plated steel frame*
- *150 cm-long garment rail with side extension bars, 40 cm each (total 240 cm)*
- *Swivel castors ø 8 cm*



Prolunga estraibile
Extension bar



Art. 1796

ARTICOLO / ARTICLE	PREZZO / PRICE	DESCRIZIONE / DESCRIPTION		MAX DIM. CM	
1795	€ 552,00	Acciaio Inox Stainless steel		150x55x153 h (con prolunghe chiuse) (with retracted extension bars)	
1796	€ 117,00	Acciaio cromato Chrome-plated steel		115x58x156 h	
OPTIONAL	PREZZO / PRICE	📷	DESCRIZIONE / DESCRIPTION	PER / FOR	
F	€ 49,00	1	Set 2 ruote con freno Set with 2 braked castors	Solo art. 1795 Only art. 1795	

CARRELLI PORTABITI E PORTABAGAGLI OTTONATI
BRASS-PLATED BIRDCAGE LUGGAGE CARTS

- Struttura in tubo di acciaio ottonato, protetto con vernice trasparente
 - Base rivestita con moquette bordeaux o nera (a seconda del modello) protetta da paracolpi perimetrale in gomma grigia
 - Ruote ø cm 16, di cui due fisse e due piroettanti con freno
- *Brass-plated steel tube frame protected by clear coat*
 - *Deck with red or black carpet (depending on the model) with full wrap-around rubber bumper*
 - *2 Fixed and 2 braked swivel castors, ø 16 cm*



Art. 1950R-E

ARTICOLO / ARTICLE	PREZZO / PRICE	COLORE MOQUETTE / CARPET COLOUR	MAX DIM. CM
1921N	€ 1.292,00	Nera / Black	79x59x189 h
1921R	€ 1.292,00	Bordeaux / Red	
1920N	€ 1.344,00	Nera / Black	99x59x189 h
1920R	€ 1.344,00	Bordeaux / Red	
1950N	€ 1.562,00	Nera / Black	108x76x189 h
1950R	€ 1.562,00	Bordeaux / Red	

OPTIONAL	PREZZO / PRICE	DESCRIZIONE / DESCRIPTION	PER / FOR
E	€ 97,00	Set 4 ruote elastiche, di cui 2 con freno, per pavimenti sconnessi o per esterno Set with 4 resilient castors, 2 with brake, for uneven floors / outdoor use	Tutti gli articoli All Articles

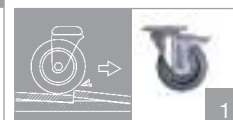

CARRELLI PORTABITI E PORTABAGAGLI CROMATI CHROME-PLATED BIRDCAGE LUGGAGE CARTS

- Struttura in tubo di acciaio cromato
 - Base rivestita con moquette bordeaux o nera (a seconda del modello)
protetta da paracolpi perimetrale in gomma grigia
 - Ruote \varnothing cm 16, di cui due fisse e due piroettanti con freno
- *Chrome-plated steel tube frame*
 - *Deck with red or black carpet (depending on the model)*
 - *Full wrap-around rubber bumper*
 - *2 Fixed and 2 braked swivel castors, \varnothing 16 cm*



Art. 1950CN

ARTICOLO / ARTICLE	PREZZO / PRICE	COLORE MOQUETTE / CARPET COLOUR	MAX DIM. CM
1922CN	€ 1.079,00	Nera / Black	79x59x189 h
1922CR	€ 1.079,00	Bordeaux / Red	
1920CN	€ 1.119,00	Nera / Black	99x59x189 h
1920CR	€ 1.119,00	Bordeaux / Red	
1950CN	€ 1.322,00	Nera / Black	108x76x189 h
1950CR	€ 1.322,00	Bordeaux / Red	

OPTIONAL	PREZZO / PRICE		DESCRIZIONE / DESCRIPTION	PER / FOR
E	€ 97,00	1	Set 4 ruote elastiche, di cui 2 con freno, per pavimenti sconnessi o per esterno Set with 4 resilient castors, 2 with brake, for uneven floors / outdoor use	Tutti gli articoli All Articles

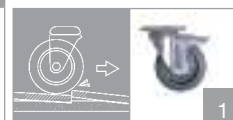

- Struttura in tubo di acciaio zincato, protetto con vernice trasparente
- Paracolpi anteriori ad anello
- Impilabili
- 2 ruote fisse ø cm 20 e 2 piroettanti ø cm 12,5
- Steel zinc-coated tube frame, protected by clear coat
- 2 front rubber ring buffers
- Stackable
- 2 Fixed castors (ø 20 cm) and 2 swivel castors (ø 12.5 cm)



Art. 1488

ARTICOLO / ARTICLE	PREZZO / PRICE	DESCRIZIONE / DESCRIPTION	MAX DIM. CM
1488	€ 522,00	Acciaio zincato Zinc-coated steel	102x60x97 h

CARRELLI PORTABAGAGLI LUGGAGE PLATFORM CARTS

- Struttura in lamiera e tubo di acciaio verniciato colore alluminio
- Base con moquette
- Barre laterali di contenimento (a seconda del modello)
- Paracolpi ad anello
- Ruote ø cm 16, di cui 2 fisse e 2 piroettanti

- *Aluminium painted steel sheet tube frame*
- *Carpeted deck*
- *Lateral retaining bars (depending on the model)*
- *Ring bumpers*
- *2 Fixed and 2 swivel castors, ø 16 cm*

200 kg



Art. 1894.1



Art. 1894.2



Art. 1894.3

ARTICOLO / ARTICLE	PREZZO / PRICE	DESCRIZIONE / DESCRIPTION	MAX DIM. CM
1894.1	€ 675,00	Aperto Without retaining bars	144x66x95 h
1894.2	€ 738,00	Chiuso da 1 lato With retaining bars on 1 side	
1894.3	€ 805,00	Chiuso da 2 lati With retaining bars on 2 sides	

OPTIONAL	PREZZO / PRICE	DESCRIZIONE / DESCRIPTION	PER / FOR
F	€ 49,00	Set 2 ruote con freno Set with 2 braked castors	Tutti gli articoli All Articles
E	€ 97,00	Set 4 ruote elastiche, di cui 2 con freno Set with 4 resilient castors, 2 with brake	

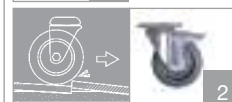

- Struttura in tubo di acciaio cromato o ottonato
- Con o senza sponda (a seconda del modello)
- Piedini in gomma
- Cinghie in PVC colore nero

- *Chrome or brass-plated tubular steel frame*
- *With or without back guard (depending on the model)*
- *Rubber feet*
- *Black PVC straps*



Art. 1755P



Art. 1750P



Art. 1756P

ARTICOLO / ARTICLE	PREZZO / PRICE	STRUTTURA / STRUCTURE	SPONDA / BACK GUARD	BASE APPOGGIO / BASE MATERIAL	MAX DIM. CM
1750P	€ 122,00	Cromato <i>Chrome-plated</i>	✓	Cinghie in PVC nero Black PVC straps	56x40x62 h
1755P	€ 115,00		-		56x33x41h
1756P	€ 128,00	Ottonato <i>Brass-plated</i>	-		56x40x62 h

CARRELLI BREAKFAST ROOM SERVICE TABLES

- Struttura in acciaio inox, finitura spazzolata
- Piano tondo in MDF nero idrorepellente, protetto da trasparente con alette laterali pieghevoli
- Possibilità di rotazione del piano a 90° per diminuire l'ingombro e consentire l'impilabilità
- Ruote piroettanti ø cm 9,5, di cui 2 con freno

- *Stainless steel construction, brushed finish*
- *Round water-repellent black MDF top protected by transparent coating, folding side leaves*
- *The top folds vertically to nest the tables together and save space*
- *Swivel castors, ø 9.5 cm, 2 with brake*

Nero *Black*



Art. 1104-80N



Ribaltabile - Impilabile
Foldable - Nestable



Le alette pieghevoli facilitano il passaggio in ambienti stretti
Folding side leaves for easy transport in narrow spaces

ARTICOLO / ARTICLE	PREZZO / PRICE	DIM. CM PIANO / TOP	MAX DIM. CM
1104-80N	€ 550,00	ø 80	ø 80x78 h
1104-90N	€ 633,00	ø 90	ø 90x78 h
1104-100N	€ 686,00	ø 100	ø 100x78 h

ARTICOLO / ARTICLE	PREZZO / PRICE	DESCRIZIONE / DESCRIPTION	PER / FOR
A0001	€ 517,00	Cassetta termica <i>Stainless steel food warmer</i>	1104-100N
A0003	€ 517,00		1104-80N - 1104-90N



1

- Struttura in acciaio inox, finitura spazzolata
- Piano quadrato in MDF nero idrorepellente, protetto da trasparente con alette laterali pieghevoli
- Possibilità di rotazione del piano a 90° per diminuire l'ingombro e consentire l'impilabilità
- Ruote piroettanti ø cm 9,5, di cui 2 con freno

- *Stainless steel construction, brushed finish*
- *Square water-repellent black MDF top protected by transparent coating, folding side leaves*
- *The top folds vertically to nest the tables together and save space*
- *Swivel castors, ø 9.5 cm, 2 with brake*

Nero *Black*



Art. 1104-Q80N



Ribaltabile - Impilabile
Foldable - Nestable

ARTICOLO / ARTICLE	PREZZO / PRICE	DIM. CM PIANO / TOP	MAX DIM. CM
1104-Q80N	€ 550,00	80x80	80x80x78 h
1104-Q90N	€ 633,00	90x90	90x90x78 h
1104-Q100N	€ 686,00	100x100	100x100x78 h

ARTICOLO / ARTICLE	PREZZO / PRICE	DESCRIZIONE / DESCRIPTION	PER / FOR
A0001	€ 517,00	Cassetta termica Stainless steel food warmer	1104-Q100N
A0003	€ 517,00		1104-Q80N - 1104-Q90N



CASSETTE TERMICHE STAINLESS STEEL FOOD WARMERS

- Struttura in lamiera di acciaio inox, finitura lucida
- Adatta a contenere piatti diametro massimo cm 32
- Maniglia in PVC per la movimentazione della cassetta
- Sportello frontale a battente, apribile a 180°
- Maniglia di apertura con chiusura calamitata
- Riscaldamento statico
- Interruttore di accensione con spia luminosa
- Termostato regolabile
- Cavo di alimentazione asportabile
- Tensione rete 230 Volt monofase-50/60 Hz

- *Stainless steel sheet construction, polished finish*
- *Suitable for plates with a max ø 32 cm*
- *PVC handle to transport the food warmer*
- *Front hinged door, opening to 180°*
- *Opening handle with magnetic closure*
- *Intermediate perforated shelf*
- *Static heating*
- *ON/OFF switch with warning light*
- *Adjustable thermostat*
- *Removable power cable*
- *Mains supply: 230V, 50/60 Hz, single-phase*

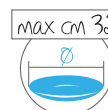
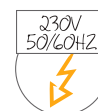
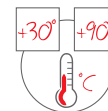

Art. A0003



ARTICOLO / ARTICLE	PREZZO / PRICE	PER ART. / SUITABLE ART.	POTENZA / POWER	MAX DIM. CM
A0001	€ 517,00	1104-100N / 1104-Q100N	400W	39x46x51 h
A0003	€ 517,00	1104-80N / 1104-90N / 1104-Q80N / 1104-Q90N		45x46x51 h

- Struttura in tubo e piani in lamiera di acciaio inox AISI 304
- Portata max 6 cassette (Art. A0001 - A0003)
- Assorbimento massimo 2400W
- Tensione rete 230 Volt monofase-50/60 Hz
- Paracolpi in gomma grigia
- Ruote piroettanti ø cm 12,5, di cui 2 con freno



- *AISI 304 stainless steel tube construction with stainless steel sheet shelves*
- *Max capacity: 6 food warmers (Art. A0001 - A0003)*
- *Max absorbed power: 2400W*
- *Mains supply: 230V, 50/60 Hz, single-phase*
- *Grey rubber ring buffers*
- *Swivel castors, ø 12.5 cm, 2 with brake*



Art. 1150 + A0003 (x6)

ARTICOLO / ARTICLE	PREZZO / PRICE	POTENZA / POWER	MAX DIM. CM
1150	€ 913,00	6 x 400W	153x56x139 h

CARRELLI PER RIFORNIMENTO MINIBAR MINIBAR RESTOCKING CUPBOARD TROLLEY

- Struttura in lamiera verniciata grigia a polveri epossidiche composta da base e 3 ripiani intermedi regolabili in altezza
 - Bacinella portabottiglie vuote asportabile in PVC
 - Maniglia laterale di spinta
 - Sportelli apribili a 180°, chiusura con chiave
 - Base con paracolpi perimetrale in gomma grigia antitraccia
 - Ruote ø cm 16, di cui 2 fisse e 2 piroettanti
- Grey epoxy powder painted steel sheet construction with 1 base and 3 intermediate height-adjustable shelves
 - Removable PVC bin for empty bottles
 - Side pushing handle
 - 180° opening doors with lock
 - All round grey non marking rubber bumper
 - 2 Fixed and 2 swivel castors, ø 16 cm



Art. 2012-F

ARTICOLO / ARTICLE	PREZZO / PRICE		MAX DIM. CM		
2012	€ 1.080,00		100x62x119 h		
OPTIONAL	PREZZO / PRICE	📷	DESCRIZIONE / DESCRIPTION	PER / FOR	
F	€ 49,00	1	Set 2 ruote con freno Set with 2 braked castors	Tutti gli articoli All Articles	 1
E	€ 97,00	2	Set 4 ruote elastiche, di cui 2 con freno Set with 4 resilient castors, 2 with brake		 2

CARRELLI PORTABIANCHERIA - PIANI IN NOBILITATO
BASIC CHAMBERMAID TROLLEYS WITH MELAMINE-FACED SHELVES

- Struttura in tubo quadro di acciaio inox cm 2x2
 - Piani in nobilitato
 - Reggisacco pieghevole con sacco portabiancheria in tela
 - Paracolpi in gomma grigia
 - Ruote piroettanti ø cm 12,5
- *Stainless steel 2x2 cm square tube frame*
 - *Melamine-faced shelves*
 - *Folding bag holder with canvas bag for dirty linen*
 - *Grey rubber bumpers*
 - *Swivel castors, ø 12.5 cm*

Rovere Oak

Rovere Tabacco
Tobacco Oak



Art. 4410T-F



Art. 4415-F

ARTICOLO / ARTICLE	PREZZO / PRICE	PIANI / SHELVES	DESCRIZIONE / DESCRIPTION	COLORE / COLOUR	MAX DIM. CM (APERTO / OPEN)	MAX DIM. CM (CHIUSO / CLOSED)
4410	€ 653,00	4	1 reggisacco pieghevole con sacco portabiancheria <i>1 folding bag holder with canvas bag for dirty linen</i>	Rovere Oak	140x52x137 h	101x52x151 h
4410T	€ 706,00			Rovere Tabacco Tobacco oak		
4415	€ 872,00	4	1 reggisacco pieghevole con sacco portabiancheria + 1 reggisacco con coperchio per sacco immondizia e pannello separazione <i>1 folding bag holder with canvas bag for dirty linen + 1 folding waste bag holder with lid and partition panel</i>	Rovere Oak	140x52x137 h	101x52x151 h
4415T	€ 941,00			Rovere Tabacco Tobacco oak		

ACCESSORI / ACCESSORIES	PREZZO / PRICE	DESCRIZIONE / DESCRIPTION	PER / FOR
R0010	€ 88,00	Sacco portabiancheria in tela <i>Canvas bag for dirty linen</i>	Tutti gli articoli <i>All Articles</i>

OPTIONAL	PREZZO / PRICE	DESCRIZIONE / DESCRIPTION	PER / FOR
F	€ 28,00	Set 2 ruote con freno <i>Set with 2 braked castors</i>	Tutti gli articoli <i>All Articles</i>
E	€ 200,00	Set 4 ruote elastiche, di cui 2 con freno <i>Set with 4 resilient castors, 2 with brake</i>	

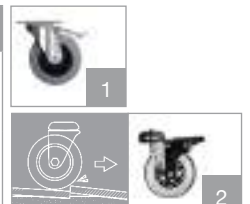

CARRELLI PORTABIANCHERIA - PIANI IN NOBILITATO BASIC CHAMBERMAID TROLLEYS WITH MELAMINE-FACED SHELVES

- Struttura in tubo quadro di acciaio inox cm 2x2
- Piani in nobilitato
- 2 reggisacco pieghevoli con sacco portabiancheria in tela
- Paracolpi in gomma grigia
- Ruote piroettanti ø cm 12,5
- *Stainless steel 2x2 cm square tube frame*
- *Melamine-faced shelves*
- *2 folding bag holders with canvas bags for dirty linen*
- *Grey rubber ring buffers*
- *Swivel castors, ø 12.5 cm*

Rovere Oak

Rovere Tabacco
Tobacco Oak



Art. 4430.90-F

ARTICOLO / ARTICLE	PREZZO / PRICE	PIANI / SHELVES	DESCRIZIONE / DESCRIPTION	COLORE / COLOUR	MAX DIM. CM (APERTO / OPEN)	MAX DIM. CM (CHIUSO / CLOSED)
4430.70	€ 625,00	(x4) 70x45	2 reggisacco pieghevole con sacco portabiancheria 2 folding bag holder with canvas bag for dirty linen	Rovere Oak	120x52x137 h	81x52x151 h
4430.70T	€ 675,00			Rovere Tabacco Tobacco oak		
4430.90	€ 674,00	(x4) 90x45	2 reggisacco pieghevole con sacco portabiancheria 2 folding bag holder with canvas bag for dirty linen	Rovere Oak	140x52x137 h	101x52x151 h
4430.90T	€ 729,00			Rovere Tabacco Tobacco oak		

ACCESSORI / ACCESSORIES	PREZZO / PRICE	DESCRIZIONE / DESCRIPTION	PER / FOR
R0010	€ 88,00	Sacco portabiancheria in tela Canvas bag for dirty linen	Tutti gli articoli All Articles

OPTIONAL	PREZZO / PRICE	DESCRIZIONE / DESCRIPTION	PER / FOR
F	€ 28,00	Set 2 ruote con freno Set with 2 braked castors	Tutti gli articoli All Articles
E	€ 200,00	Set 4 ruote elastiche, di cui 2 con freno Set with 4 resilient castors, 2 with brake	

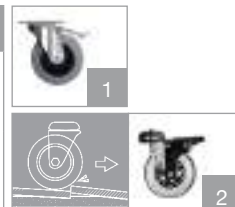

CARRELLI PORTABIANCHERIA - PIANI IN NOBILITATO
EQUIPABLE HOUSEKEEPING TROLLEYS WITH MELAMINE-FACED SHELVES

- Struttura in tubo quadro di acciaio inox cm 2x2
- Piani e pannelli in nobilitato
- Reggisacco pieghevole con sacco portabiancheria in tela
- Base con paracolpi perimetrale in gomma grigia antitraccia
- Ruote piroettanti ø cm 12,5

- *Stainless steel 2x2 cm square tube frame*
- *Melamine-faced shelves and side panels*
- *Folding bag holder with canvas bag for dirty linen*
- *All round grey non marking rubber bumper*
- *Swivel castors, ø cm 12.5*

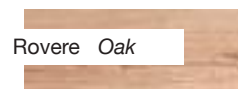

Rovere Oak

Rovere Tabacco
Tobacco Oak



Art. 4450-F



Art. 4451-F



Art. 4452-F

ARTICOLO / ARTICLE	PREZZO / PRICE	COLORE / COLOR	DESCRIZIONE / DESCRIPTION	MAX DIM. CM (APERTO / OPEN)	MAX DIM. CM (CHIUSO / CLOSED)
4450	€ 750,00	Rovere Oak	base cm 73 73 cm Base	102x52x134 h	73x52x151 h
4450T	€ 810,00	Rovere Tabacco Tobacco oak			
4451	€ 802,00	Rovere Oak	base cm 73 + pannelli laterali 73 cm Base + side panels		
4451T	€ 870,00	Rovere Tabacco Tobacco oak			
4452	€ 845,00	Rovere Oak	base cm 73 + pannelli su tre lati 73 cm Base + panels on 3 sides		
4452T	€ 912,00	Rovere Tabacco Tobacco oak			
4470	€ 772,00	Rovere Oak	base cm 93 93 cm Base	119x52x134 h	93x52x151 h
4470T	€ 833,00	Rovere Tabacco Tobacco oak			
4471	€ 840,00	Rovere Oak	base cm 93 + pannelli laterali 93 cm Base + side panels		
4471T	€ 908,00	Rovere Tabacco Tobacco oak			
4472	€ 900,00	Rovere Oak	base cm 93 + pannelli su tre lati 93 cm Base + panels on 3 sides		
4472T	€ 971,00	Rovere Tabacco Tobacco oak			
4490	€ 814,00	Rovere Oak	base cm 113 113 cm Base	139x52x134 h	113x52x151 h
4490T	€ 879,00	Rovere Tabacco Tobacco oak			
4491	€ 881,00	Rovere Oak	base cm 113 + pannelli laterali 113 cm Base + side panels		
4491T	€ 950,00	Rovere Tabacco Tobacco oak			
4492	€ 957,00	Rovere Oak	base cm 113 + pannelli su tre lati 113 cm Base + panels on 3 sides		
4492T	€ 1.033,00	Rovere Tabacco Tobacco oak			

ACCESSORI CARRELLI PORTABIANCHERIA - PIANI IN NOBILITATO
EQUIPABLE HOUSEKEEPING TROLLEYS WITH MELAMINE-FACED SHELVES



Cassetta portaoggetti
con coperchio e serratura
*Top loading compartmental tray
for amenities with lid and lock*



oppure / or

Cassetta portaoggetti
*Top loading compartmental tray
for amenities*



Art. A43
Reggisacco pieghevole
con coperchio per sacco immondizia
e pianetto poggiacppo

Art. A43
*Folding waste bag holder with
lid, partition panel and small bag
support shelf*



oppure / or

Art. A41
Reggisacco pieghevole con sacco
portabiancheria in tela

Art. A41
*Folding bag holder ring with
canvas bag for dirty linen*

OPTIONAL	PREZZO / PRICE	📷	DESCRIZIONE / DESCRIPTION	PER / FOR
F	€ 49,00	1	Set 2 ruote con freno <i>Set with 2 braked castors</i>	Tutti gli articoli <i>All Articles</i>
E	€ 97,00	2	Set 4 ruote elastiche, di cui 2 con freno <i>Set with 4 resilient castors, 2 with brake</i>	
ACCESSORI / ACCESSORIES	PREZZO / PRICE		DESCRIZIONE / DESCRIPTION	PER / FOR
A41	€ 100,00		Reggisacco pieghevole con sacco portabiancheria in tela <i>Folding bag holder with canvas bag for dirty linen</i>	Tutti gli articoli <i>All Articles</i>
A43	€ 154,00		Reggisacco pieghevole con coperchio per sacco immondizia e pianetto poggiacppo <i>Folding waste bag holder with lid and small bag support shelf</i>	
A44-70	€ 130,00		Cassetta portaoggetti cm 60 <i>Top loading compartmental tray, 60 cm</i>	con base 93 cm <i>with 93 cm base</i>
A45-70	€ 279,00		Cassetta portaoggetti con coperchio e serratura cm 60 <i>Top loading compartmental tray with lid and lock, 60 cm</i>	
A44-90	€ 148,00		Cassetta portaoggetti cm 80 <i>Top loading compartmental tray, 80 cm</i>	con base 113 cm <i>with 113 cm base</i>
A45-90	€ 304,00		Cassetta portaoggetti con coperchio e serratura cm 80 <i>Top loading compartmental tray with lid and lock, 80 cm</i>	
R0015	€ 88,00		Sacco portabiancheria in tela <i>Canvas bag for dirty linen</i>	Tutti gli articoli <i>All Articles</i>



CARRELLI PORTABIANCHERIA ARMADIATI EQUIPABLE HOUSEKEEPING CUPBOARD TROLLEYS

- Struttura in lamiera verniciata grigia a polveri epossidiche
- Reggisacco pieghevole con sacco portabiancheria in tela (a seconda del modello)
- Supporto per sacco immondizia con coperchio (a seconda del modello)
- Base con paracolpi perimetrale in gomma grigia antiraccia
- Ruote ø cm 16, di cui 2 fisse e 2 piroettanti

- *Steel sheet structure with grey epoxy powder coating*
- *Folding bag holder with canvas bag (depending on the model)*
- *Waste bag holder with lid (depending on the model)*
- *All round grey non marking rubber bumper*
- *2 Fixed and 2 swivel castors, ø 16 cm*



Art. 2020-F



Art. 2022-F



Art. 2026S-F



Art. 2024S-F

ARTICOLO / ARTICLE	PREZZO / PRICE	SACCO TELA / CANVAS BAG	SET SACCO IMMONDIZIA / WASTE BAG SET	SPORTELLI / DOORS	MAX DIM. CM (APERTO / OPEN)	MAX DIM. CM (CHIUSO / CLOSED)
2020	€ 827,00	-	-	-	100x62x118 h	100x62x145 h
2022	€ 921,00	1	-		130x62x118 h	
2026	€ 1.111,00	1	1		160x62x118 h	
2024	€ 1.014,00	2	-		160x62x118 h	
2020S	€ 1.043,00	-	-	2	100x62x118 h	
2022S	€ 1.134,00	1	-		130x62x118 h	
2026S	€ 1.326,00	1	1		160x62x118 h	
2024S	€ 1.227,00	2	-		160x62x118 h	

OPTIONAL	PREZZO / PRICE		DESCRIZIONE / DESCRIPTION	PER / FOR
F	€ 49,00	1	Set 2 ruote con freno Set with 2 braked castors	Tutti gli articoli All Articles
E	€ 97,00	2	Set 4 ruote elastiche, di cui 2 con freno Set with 4 resilient castors, 2 with brake	



CARRELLI PORTABIANCHERIA ARMADIATI
EQUIPABLE HOUSEKEEPING CUPBOARD TROLLEYS



Art. A45-90
Cassetta portaoggetti con
coperchio e serratura cm 80

Art. A45-90
Top loading compartmental tray for
amenities with lid and lock, 80 cm



Art. 2026S-F + A45-90

ACCESSORI / ACCESSORIES	PREZZO / PRICE		DESCRIZIONE / DESCRIPTION	PER / FOR
A45-90	€ 304,00	3	Cassetta portaoggetti con coperchio e serratura <i>Top loading compartmental tray with lid&lock</i>	Tutti gli articoli <i>All Articles</i>
A44-90	€ 148,00	4	Cassetta portaoggetti aperta <i>Open top loading compartmental tray</i>	
R0015	€ 88,00	5	Sacco portabiancheria in tela <i>Canvas bag for dirty linen</i>	

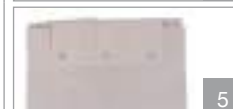

PATTUMIERE IN ACCIAIO INOX E PORTASACCHI STAINLESS STEEL WASTE BINS AND SACK-HOLDERS

- Pattumiera rettangolare in acciaio inox lucido
- Coperchio con apertura a pedale
- Elastico ferma-sacco
- Apertura ad anta
- Base con 2 ruote

- *Polished stainless steel rectangular waste bin*
- *Pedal operated opening*
- *Elastic fastening bag holder*
- *Front door*
- *Base with 2 wheels*



Art. 2466



Art. 2467

- Portasacco su ruote, in metallo laccato bianco
- Coperchio con apertura a pedale
- Base con 2 ruote posteriori e 2 piedini anteriori
- *Wheeled white lacquered metal waste sack-holder*
- *Pedal operated opening*
- *Base with 2 wheels and 2 front feet*







Art. 2438

- Pattumiera portasacco in acciaio inox AISI 304
- Coperchio con apertura a pedale
- Base con 2 ruote posteriori e 2 piedini anteriori
- *AISI 304 stainless steel dustbin for big waste sacks*
- *Pedal operated opening*
- *Base with 2 wheels and 2 front feet*



Art. 2435

ARTICOLO / ARTICLE	PREZZO / PRICE	CAPACITÀ LT / LT CAPACITY	MAX DIM. CM				
2466	€ 394,00	70	46x36x70 h	10,1	M	50x50x79 h	12
2467	€ 452,00	110	46x36x90 h	13,1		48x45x95 h	15,3
2438	€ 253,00	110	ø 41x100 h	12,5	M	63x57x100 h	13,5
2435	€ 254,00		55x45x85 h	9,5		50x50x90 h	10,5

SVUOTAVASSOI FAST-FOOD RUBBISH BINS

- Struttura in lamiera di acciaio inox AISI 430 (Art. 2591)
 - Struttura in lamiera zinco plastificata (Art. 2592 - 2593 - 2594 - 2596 - 2598)
 - Ripiano superiore con alzatina ferma vassoi su 3 lati
 - Sportello basculante per svuotamento vassoi
 - Anta inferiore portasacco con chiusura a chiave
 - Piedini in nylon regolabili
- *AISI 430 stainless steel sheet structure (art. 2591)*
 - *Plastic-coated galvanized sheet structure (Art. 2592 - 2593 - 2596 - 2598)*
 - *Raised edge top for trays*
 - *Swinging door for trays cleaning*
 - *Sack-holder lower lockable door*
 - *Adjustable nylon feet*



TABELLA COLORI COLOUR TABLE

Acciaio inox Grigio
Stainless steel Grey



Art. 2591

Art. 2592

Bianco
White

Beige
Beige



Art. 2593

Art. 2594

Noce
Walnut

Wengé
Wengé



Art. 2596

Art. 2598



Art. 2592



Art. 2591

ARTICOLO / ARTICLE	PREZZO / PRICE	COLORE / COLOUR	CAPACITÀ LT / LT CAPACITY	MAX DIM. CM	Kg			Kg
2591	€ 1.286,00	Acciaio inox Stainless steel	80	60x60x120 h	42	M	65x65x130 h	50
2592	€ 1.229,00	Grigio Grey						
2593	€ 1.229,00	Bianco White						
2594	€ 1.229,00	Beige Beige						
2596	€ 1.229,00	Noce Walnut						
2598	€ 1.229,00	Wengé Wengé						

- Struttura in acciaio inox satinato anti-traccia
- Coperchio con apertura a pedale in polipropilene e acciaio inox
- Sistema di chiusura del coperchio soft-close
- Maniglie laterali
- Secchi interni in polipropilene
- Base in ABS
- Prodotto conforme al metodo HACCP

- *Stainless steel structure, non-marking brushed finish*
- *Polypropylene and stainless steel lids*
- *Softclose closing*
- *Built-in side handles*
- *Polypropylene internal buckets*
- *ABS base*
- *Product compliant with HACCP system*



Particolare secchi interni

Internal buckets detail



Art. 2560



Art. 2561



Art. 2562

ARTICOLO / ARTICLE	PREZZO / PRICE	CAPACITÀ LT / LT CAPACITY	MAX DIM. CM	Kg			Kg
2560	€ 199,00	2x12	41x39x43 h	4,5	M	44x41x48 h	5
2561	€ 266,00	3x12	60x39x43 h	6		63x41x47 h	6,5
2562	€ 371,00	2x30	48x46x64 h	9,5		48x53x69 h	10

PATTUMIERE PER LA RACCOLTA DIFFERENZIATA RECYCLING BINS

- Struttura in metallo laccato bianco
- Coperchio con apertura basculante
- Anello reggisacco interno
- *White lacquered metal structure*
- *Opening lid*
- *Sack-holder fastening ring*



ARTICOLO / ARTICLE	PREZZO / PRICE	DESCRIZIONE / DESCRIPTION	CAPACITÀ LT / LT CAPACITY	MAX DIM. CM	Kg			Kg
25100B	€ 269,00	Blu per CARTA Blue for PAPER	45	30x30x70 h	7,3	M	32x32x77,50 h	8,2
25100R	€ 269,00	Rosso per GENERICO Red for WASTE						
25100V	€ 269,00	Verde per VETRO Green for GLASS						
25100G	€ 269,00	Giallo per PLASTICA Yellow for PLASTIC						
25100GR	€ 269,00	Grigio per LATTINE Grey for TIN CANS						
25100M	€ 269,00	Marrone per UMIDO Brown for ORGANIC						





PATTUMIERE PER LA RACCOLTA DIFFERENZIATA
RECYCLING BINS

- Contenitore a 3 fori con 3 portasacco interni in tondino
- Struttura in metallo verniciato nero
- Dotazione standard: Carta/Paper - Vetro/Glass - Plastica/plastic, altre combinazioni disponibili su richiesta
- 3-hole recycling bin with 3 internal sack holders
- Black lacquered metal structure
- Standard equipment: Carta/Paper - Vetro/Glass - Plastica/Plastic, more combinations available upon request



Art. 25200



ARTICOLO / ARTICLE	PREZZO / PRICE	CAPACITÀ LT / LT CAPACITY	MAX DIM. CM				
25200	€ 520,00	3x25	50x50xh.79,5	13,9	M	48x48x74 h	15,5

PATTUMIERE PICCOLE SMALL METAL WASTE BINS

- Finitura in acciaio inox brillante o in acciaio zincato verniciato bianco
- Apertura a pedale (in metallo rivestito in plastica per la versione inox e in plastica per la versione bianca)
- Maniglia di trasporto richiudibile in plastica
- Base in plastica
- N.B. - ORDINE MINIMO (a seconda del modello)
- Finitura in acciaio inox brillante (AISI 430) o in metallo zincato verniciato bianco
- Apertura a pedale (in plastica)
- Coperchio con chiusura silenziosa
- Maniglia di trasporto posteriore
- Sistema di bloccaggio del coperchio per ricambio sacco
- Secchio interno in plastica
- Base in plastica

- Polished stainless steel or white painted galvanized steel
- Pedal operated opening (plastic - coated metal for the steel version and plastic for the white model)
- Foldable plastic handle
- Plastic base
- N.B. - MINIMUM ORDER (depending on the model)
- Polished stainless steel (AISI 430) or white painted galvanized metal
- Plastic pedal operated opening
- Soft-closing lid
- Handle
- Lid locking system for bag replacement
- Internal plastic bucket
- Plastic base



ARTICOLO / ARTICLE	PREZZO / PRICE	COLORE / COLOR	ORDINE MINIMO / MIN ORDER	CAPACITÀ LT / LT CAPACITY	MAX DIM. CM							
2493	€ 30,00	Inox brillante <i>Polished stainless steel</i>	8 pz./pcs.	3	ø 18,5x25 h	0,74	M	39x76x26,5 h	6			
2493B	€ 28,00	Bianco <i>White</i>										
2494	€ 38,00	Inox brillante <i>Polished stainless steel</i>		4	ø 22,3x26,5 h					0,96	48x90x28,5 h	8
2494B	€ 36,00	Bianco <i>White</i>										
2495	€ 65,00	Inox brillante <i>Polished stainless steel</i>	6 pz./pcs.	12	ø 26x36 h	1,5	55x79,5x38 h	9				
2495B	€ 60,00	Bianco <i>White</i>										
2496	€ 120,00	Inox brillante <i>Polished stainless steel</i>	-	20	ø 29x45 h	2,5	33x33x50 h	3				
2496B	€ 114,00	Bianco <i>White</i>										

PATTUMIERE / GETTACARTE IN ACCIAIO INOX
STAINLESS STEEL WASTE/PAPER BINS

- Contenitore rettangolare in acciaio inox lucido
- Coperchio basculante in acciaio inox antigraffio
- Rectangular polished stainless steel paper bins
- Non-scratch stainless steel swing lid



Art. 2431



Art. 2432

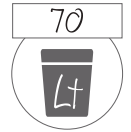

ARTICOLO / ARTICLE	PREZZO / PRICE	CAPACITÀ LT / LT CAPACITY	MAX DIM. CM	Kg			Kg
2431	€ 311,00	30	30x20x70 h	4	M	33x24x75 h	5
2432	€ 343,00	70	40x30x90 h	9		46x35x91 h	10

ACCESSORI / ACCESSORIES	PREZZO / PRICE		DESCRIZIONE / DESCRIPTION	PER / FOR	
BIN1	€ 25,00	1	Cestello portasacco in tondino di acciaio Steel rod bag holder	2431	
BIN2	€ 30,00			2432	

- Gettacarte push in acciaio inox o in metallo laccato nero
- Sportello con apertura a pressione
- Stainless steel or black lacquer metal paper bin
- Push opening



Art. 2404



Art. 2407



ARTICOLO / ARTICLE	PREZZO / PRICE	COLORE / COLOR	CAPACITÀ LT / LT CAPACITY	MAX DIM. CM	Kg			Kg
2404	€ 234,00	Acciaio inox Stainless Steel	45	ø 30x83 h	6	M	36x36x94 h	7
2407	€ 177,00	Nero Black						

ACCESSORI / ACCESSORIES	PREZZO / PRICE		DESCRIZIONE / DESCRIPTION	PER / FOR	
BIN3	€ 83,00	2	Secchio in lamiera zincata Galvanized sheet metal bucket	2404 - 2407	

POSACENERE / GETTACARTE
ASHTRAY TOP PAPER BINS

- Posacenere/gettacarte con coperchio a rete
- *Stainless steel or brass litter bin with ashtray mesh top*



- Posacenere/gettacarte con griglia setaccio
- *Stainless steel or lacquered metal paper bin with ashtray top*



ARTICOLO / ARTICLE	PREZZO / PRICE	COLORE / COLOR	MAX DIM. CM	Kg			Kg
2506	€ 156,00	Acciaio inox lucido <i>Polished stainless steel</i>	ø 20x60 h	3	M	23x23x65 h	4
2508	€ 246,00	Ottonato <i>Brass-plated</i>					
2510	€ 184,00	Acciaio inox lucido <i>Polished stainless steel</i>	ø 25x69 h	4		28x28x76 h	5
2512	€ 284,00	Ottonato <i>Brass-plated</i>					
2530N	€ 111,00	Laccato nero micaceo <i>Black micaceous lacquer</i>	ø 25x62 h				
2531	€ 131,00	Acciaio inox lucido <i>Polished stainless steel</i>					

ACCESSORI / ACCESSORIES	PREZZO / PRICE		DESCRIZIONE / DESCRIPTION	PER / FOR	
BIN6	€ 21,00	1	Cestello portasacco in tondino di acciaio <i>Steel rod bag holder</i>	2510 - 2512	
BIN7	€ 21,00			2530N - 2531	

- Portaombrelli quadrato in acciaio inox satinato o in metallo laccato nero
- *Squared umbrella stands - satin stainless steel or black lacquered metal*



Art. 2760



Art. 2761





- Portaombrelli in metallo laccato nero o bianco, rifinito inox o ottone
- *Black or white lacquered metal umbrella stand with stainless steel or brass final touches*



Art. 2786



Art. 2788

ARTICOLO / ARTICLE	PREZZO / PRICE	COLORE / COLOR	MAX DIM. CM				
2760	€ 129,00	Inox satinato <i>Satin stainless steel</i>	24x24x49 h	6	M	26x26x53 h	3,5
2761	€ 107,00	Inox satinato <i>Black</i>					
2786	€ 110,00	Nero / inox <i>Black/stainless steel</i>	ø 25x50 h				
2788	€ 110,00	Nero / ottone <i>White/stainless steel</i>					

PULIZIA E CURA DELLE SUPERFICI IN ACCIAIO INOX CLEANING AND CARE OF STAINLESS STEEL SURFACES

L'acciaio inox utilizzato nelle apparecchiature professionali è di alta qualità e con una corretta manutenzione può garantire un lungo utilizzo senza incorrere in particolari problemi. Non bisogna però pensare che l'acciaio inox sia indistruttibile e che possa resistere a qualunque danno o corrosione.

L'acciaio inossidabile (o inox), caratterizzato dalla presenza all'interno della lega metallica di cromo ed eventualmente di altri elementi leganti (come molibdeno, nichel ecc.), è così chiamato in virtù della sua alta resistenza alla corrosione. Questa resistenza è dovuta ad un sottilissimo strato di ossidi/idrossidi di cromo che si forma sulla superficie dell'acciaio grazie all'ossigeno assorbito per esposizione all'aria del metallo stesso.

Questo sottile strato protettivo garantisce la resistenza del metallo contro la corrosione, ovvero gli permette di non arrugginirsi come un normale acciaio al carbonio.

Se però questo strato protettivo viene danneggiato meccanicamente o chimicamente (graffi, incisioni, tagli, uso di prodotti corrosivi, candeggina, ecc.), e se la sua riformazione viene impedita isolandolo dall'ossigeno presente nell'aria, allora anche il miglior acciaio inox può andare incontro a fenomeni di corrosione e quindi arrugginirsi.

Di seguito elenchiamo una serie di avvertenze da rispettare per far sì che le apparecchiature in acciaio inox si mantengano in ottime condizioni di utilizzo nel tempo:

- Mantenere le superfici pulite ed asciutte, garantendone il contatto con l'aria;
- Utilizzare solo detergenti neutri senza polveri abrasive o candeggina, avendo cura di risciacquare bene la superficie con acqua pulita ed asciugarla con un panno pulito;
- Non pulire mai le apparecchiature con getti di acqua ad alta pressione;
- Non lasciare mai a contatto per tempi prolungati le superfici in acciaio inox con sostanze acide (anche senape, aceto, pomodoro ecc.), sale o candeggina.
- Evitare contatti prolungati delle superfici in acciaio inox con superfici o oggetti costituiti da normale acciaio al carbonio (non inossidabile). Un contatto prolungato tra acciai inossidabili ed acciai al carbonio, potrebbe causare l'innesco di celle galvaniche in presenza di un elettrolita, causando la corrosione del metallo meno nobile.
- Evitare che sull'acciaio inossidabile possano depositarsi particelle di acciaio al carbonio (non inossidabile): spruzzi di saldatura, limatura di ferro o simili. Questi depositi possono dar luogo ad effetti di corrosione localizzata anche solo a contatto con l'aria, pregiudicando la corretta formazione dello strato di ossido protettivo dell'acciaio inox.
- Non graffiare, scalfire o tagliare le superfici in acciaio inox. Evitare di utilizzare oggetti appuntiti o taglienti sulle superfici.
- Eventuali piccoli segni di corrosione o ruggine vanno immediatamente eliminati utilizzando prodotti specifici, blandi abrasivi o carta vetrata molto fine (in casi eccezionali). In caso di segni di ruggine e corrosione più estesi, si può utilizzare acido ossalico diluito al 5%. Avere sempre cura di risciacquare con acqua pulita la superficie dopo il trattamento ed asciugarla bene con un panno pulito.

The stainless steel used in professional equipment is of high quality and if properly maintained it can allow long use without incurring in any problem. It would however be wrong to think that stainless steel is indestructible and can resist any kind of damage or corrosion.

Stainless steel (or inoxidizable steel), which is characterized by the presence of chromium within the metal alloy and possibly other alloying elements (such as molybdenum, nickel, etc.), is so called because of its high resistance to corrosion. This resistance is due to a very thin layer of chromium oxides / hydroxides that forms on the surface of the steel thanks to the oxygen absorbed by exposure to the air of the metal itself.

This thin protective layer ensures the metal resistance against corrosion, i.e. it allows it not to rust like normal carbon steel.

However, should this protective layer be damaged by mechanical or chemical action (scratches, dents, cuts, use of bleach and corrosive agents, etc.), and if its reformation is prevented by isolating it from the oxygen present in the air, then even the best stainless steel can undergo corrosion phenomena and therefore rust.

Here below we list specific warnings to be respected to ensure that the stainless steel appliances remain in excellent conditions of use over time:

- *Keep the surfaces clean and dry, ensuring contact with the air;*
 - *Use only neutral detergents without abrasive powders or bleach, making sure to rinse the surface thoroughly with clean water and to dry it with a clean cloth;*
 - *Never clean the appliances with high pressure water jets;*
 - *Never leave the stainless steel surfaces in contact for a long time with acid substances (including mustard, vinegar, tomato, etc.), salt or bleach.*
 - *Avoid prolonged contact of stainless steel surfaces with surfaces or objects made of normal (non-stainless) carbon steel. Prolonged contact between stainless steels and carbon steels could cause the ignition of galvanic cells in the presence of an electrolyte, causing corrosion of the less noble metal.*
 - *Avoid that carbon steel particles (not stainless) can deposit on the stainless steel surfaces: welding spatter, iron filings or the like. These deposits may produce localized corrosion even just with contact with the air, inhibiting the formation of the protective oxide layer of stainless steel.*
 - *Do not scratch, gouge or cut the stainless steel surfaces. Avoid using sharp objects on stainless steel surfaces.*
 - *Any small signs of corrosion or rust must be immediately removed using specific products, mild abrasives or very fine sandpaper (only in exceptional cases).*
- In case of extended signs of rust and corrosion, 5% diluted oxalic acid may be used. Always make sure to rinse the surface with clean water after treatment and dry it well with a clean cloth.*

EFFETTI DI ALCUNE SOSTANZE SULL'ACCIAIO INOX / EFFECTS OF SOME SUBSTANCES ON STAINLESS STEEL

 NON UTILIZZARE / DO NOT USE	Acido cloridrico	Hydrochloric acid
	Acido fluoridrico	Hydrofluoric acid
	Acido muriatico	Muriatic acid
	Candeggina	Bleach
	Gas di cloro umido	Damp chlorine gas
	Solfato di rame 10%	Copper sulphate 10%
 Nessun effetto dannoso se l'acciaio viene risciacquato e asciugato dopo l'utilizzo / No harmful effect if the steel is rinsed and dried after use	Acqua ragia	Turpentine
	Alcool	Alcohol
	Bicarbonato di sodio	Sodium bicarbonate
	Sapone	Soap
	Solventi (benzolo, trielina...)	Solvents (triethylene, benzol...)
	Vernici	Paints







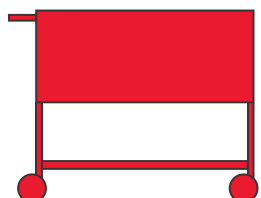
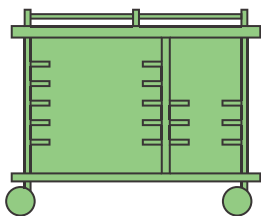
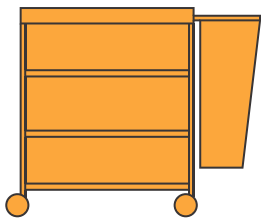
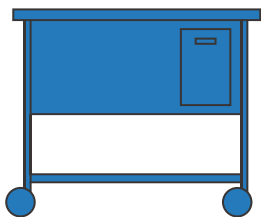
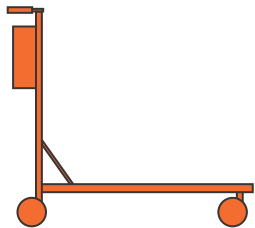
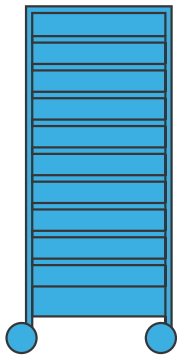

Metalcarrelli s.r.l.

Via A. Gagliani, 10/A
47187 Bellaria - Igea Marina (RN)) ITALY
ph: +39 0541 331627 | fax: +390541 331561
info@metalcarrelli.com

WWW.METALCARRELLI.COM